

Structural Reliability Methods

O. Ditlevsen and H.O. Madsen

DEPARTMENT OF MECHANICAL ENGINEERING
TECHNICAL UNIVERSITY OF DENMARK
JUNE-SEPTEMBER 2007

Copyright © O. Ditlevsen and H.O. Madsen 2007
All rights reserved

Department of Mechanical Engineering
Technical University of Denmark

Publication Reference Data

O. Ditlevsen and H.O. Madsen,
Structural Reliability Methods.
Monograph
(First edition published by John Wiley & Sons Ltd, Chichester, 1996,
ISBN 0 471 96086 1)
Internet edition 2.3.7
<http://www.od-website.dk/index-2.html/books.htm>.
June-September 2007

Preface

This internet publication is the second edition of *Structural Reliability Methods* and is a corrected and slightly revised version of the first edition published by Wiley, Chichester 1996 (ISBN 0-471-96086-1). The Appendixes 4 and 5 about the reliability software packages PROBAN and STRUREL are not included in the second edition. Instead some web addresses are listed at the reading path diagram below. Peter and Elena Friis-Hansen are acknowledged for help with recovering of text files (typed by Annette Bærentzen as the publishers basis for the first edition) and figure files (worked out by former Ph. D. students).

This is the third web edition 2.3.7 [Ed.2.3.7 is of June 2007 (including a small correction added September 2007 in Example 13.4) with some new text on simulation on a cone and some new text on SORM applied to the FBC load combination problem, Ed. 2.2.5 is of June-July 2005 (several corrections), January 2005 (minor corrections), March 2004 (minor corrections), Ed. 2.2 is of May 2003, Ed. 2.1 is of September 2002]. The authors welcome any further corrections and remarks received from the readers.

The book is a revised and extended translation of a Danish text: SBI-rapport 211: *Bærende Konstruktioners Sikkerhed*, 1990, published by the Danish Building Research Institute. The first Danish textbook on structural reliability written as a basis for lectures given at the Department of Structural Engineering at the Technical University of Denmark is *Konstruktioners Sikkerhed (Safety of Structures)* by C. Dyrbye, S. Gravesen, S. Krenk, N.C. Lind and H.O. Madsen from 1979 (Den private Ingeniørfond ved Danmarks tekniske Højskole). The present book does not cover as wide a field as *Konstruktioners Sikkerhed*. Besides introducing the reliability methods the mentioned book contains much material about specific strength and action models, that is, topics only rudimentary considered in the present book. On the other hand, the present book is considerably more extensive concerning the reliability methods that have become practicable in the later years mainly due to the development of fast computers.

The textbook *Konstruktioners Sikkerhed* has been the basis for a more extensive version in English written by three of the authors: *Methods of Structural Safety* by H.O. Madsen, S. Krenk and N.C. Lind from 1986 (Prentice-Hall, Inc.), a monograph that has gained considerable international recognition. It is recommended as a supplement to the present book, in particular with respect to detailed strength and action models and with respect to response analysis based on the theory of random processes. The influence of *Konstruktioners Sikkerhed* can also be traced in another English textbook written in a Danish-British cooperation between P. Thoft-Christensen and M.J. Baker: *Structural Reliability Theory and Its Applications* from 1982 (Springer-Verlag). This book is much more elementary and broad-written than *Methods of Structural Safety* and it has been well received as a guidance for the first steps into the subject.

The present book *Structural Reliability Methods* treats both the philosophy and the methods

more deeply. It can be read in several rounds dependent on the amount of detailed knowledge sought by the reader. Figure 0.1 shows possible starting points and reading paths. This is not to say that cross references to material outside the recommended reading paths do not show up, but in such cases only limited reading is necessary at these references.

Besides the guidance given by this reading path diagram, several sections are marked by * indicating that the section in question can be jumped without causing severe difficulties for the continued reading. These marks are set independently of the reading path diagram. Reading in the succession of the chapters with jumping of the marked sections is judged to give a sufficient first introduction to the probabilistic methods for the evaluation of structural reliability including the philosophy on which the methods are based. The introduction is sufficient for reading Appendix 3 which is a revised reprint of a JCSS Working Document from 1989 exemplifying a proposal for a code for the direct use of reliability methods in structural design. (JCSS = Joint Committee on Structural Safety).

The text of the book is organized in main text, examples and remarks. The symbol □ at the end of a text shows that at this place an example or a remark ends.

It is assumed that the reader has an elementary background in probability calculus and statistical reasoning. Thus it is assumed that words like stochastic and deterministic do not cause trouble and that concepts as mean value, standard deviation, coefficient of variation, covariance, correlation coefficient, distribution function, density function, probability, sample, etc. are well known to the reader. As an aid for recalling, special remarks are given at relevant places. These remarks sum up the definitions and theorems that are most important in the given context. Necessary mathematical concepts that are judged to be beyond the most elementary general knowledge are introduced more carefully.

Similar remarks apply concerning the necessary knowledge of strength of materials and structural analysis. By and large it is only required that the reader know about the equilibrium principles, the concepts of stress and strain, and is acquainted with elementary elasticity and plasticity theory.

Kgs. Lyngby, June 2007

Ove Ditlevsen

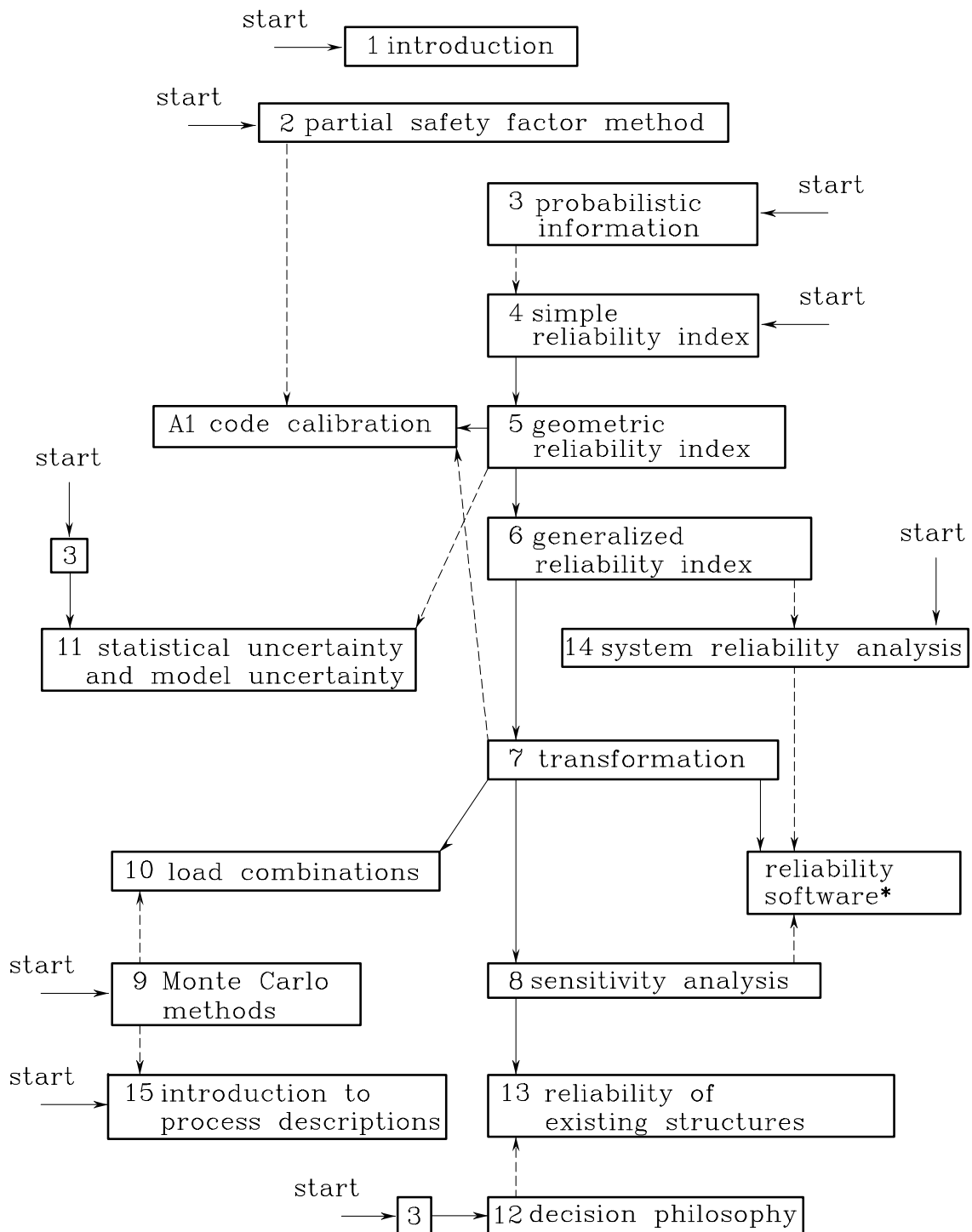

Figure 1: Reading path diagram with several possible starting points and tracks for the reading. It shows that several chapters can be read separately or in pairs almost independently of the other chapters.

* Commercial reliability software is available on the web addresses:
[http:// www.strurel.de](http://www.strurel.de)
<http://info.uibk.ac.at/c/c8/c810/SoftwareDevelopment/index.html>
<http://www.ce.berkeley.edu/ adk/software.htm>

This page is intentionally left blank.

Contents

Preface	i
Contents	iv
1 INTRODUCTION	1
1.1 Probabilistic and deterministic models	1
1.2 The safety problem	2
1.3 Formal systems of judgment evaluation	3
1.4 The tolerance system	4
1.5 Interpretation of the concept of probability	4
1.6 Compatibility of the probability interpretations	6
1.7 Knowledge related nature of the reliability measure	7
1.8 Ambiguity problem	7
1.9 Determination of the reliability level by optimization	8
1.10 Consequence-calculation principle governing the development of the codes	9
1.11 Optimality postulate	10
1.12 The following chapters	10
1.13 Epilogue	11
2 PARTIAL SAFETY FACTOR METHOD	13
2.1 Limit states	13
2.2 The safety factor concept and the requirement of formulation invariance*	16
2.3 Probability considerations concerning the safety factor*	18
2.4 Partial safety factors	20
2.5 Allowable degree of arbitrariness of the choice of partial safety factor values*	24
2.6 Action models	26
2.7 Load combinations*	28
2.8 Historical and bibliographical notes	31

3	PROBABILISTIC INFORMATION	33
3.1	Randomness and uncertainty	33
3.2	Statistical uncertainty	36
3.3	Model uncertainty	40
3.4	Model-uncertainty evaluation and its inclusion in the reliability analysis*	48
3.5	Objectivity of the structural reliability analysis method *	52
4	SIMPLE RELIABILITY INDEX	57
4.1	Limited probabilistic information	57
4.2	Calculus for linear safety margins	57
4.3	Linear regression	64
4.4	Geometric calculations by use of linear regression	69
4.5	The standardized multidimensional normal distribution	71
5	GEOMETRIC RELIABILITY INDEX	75
5.1	Nonlinear safety margin. Linearization problem	75
5.2	The geometric reliability index	77
5.3	Determination of a locally most central limit-state point by use of linear regression	79
5.4	Historical and bibliographical notes	84
6	GENERALIZED RELIABILITY INDEX	87
6.1	Shortcomings of the geometric reliability index	87
6.2	Generalized reliability index	90
6.3	Reliability index bounds for convex polyhedral safe sets	94
6.4	Asymptotic reliability index for curved limit-state surface. Definition of "almost plane" limit-state surface (single-point FORM or SORM)	102
6.5	Polyhedral approximation to arbitrary safe sets (multi-point FORM or SORM)	106
6.6	Polyhedral approximation at singular points on the limit-state surface (single-point multiple FORM or SORM)	108
6.7	Historical and bibliographical notes	109
7	TRANSFORMATION	111
7.1	Informational asymmetry	111
7.2	Some important transformations	115
7.3	On differentiable mappings and surfaces	127
7.4	The normal tail-approximation principle for determination of locally most central limit-state points	129

7.5	Approximate calculation of values of the multi-dimensional normal distribution function by use of FORM and SORM*	136
7.6	Reliability analysis for limit states of high complexity	138
7.7	Historical and bibliographical notes	146
8	SENSITIVITY ANALYSIS	149
8.1	Measure for the importance of input variables	149
8.2	Importance measures related to input parameters for element reliability	152
8.2.1	One parameter case	152
8.2.2	The two main cases	154
8.2.3	Several parameters	155
8.2.4	Choice of expansion function	156
8.3	Importance measures related to the input parameters for parallel-system reliability*	157
8.4	Importance measures related to input parameters in series-system reliability*	162
8.5	Historical and Bibliographical notes	163
9	MONTE CARLO METHODS	165
9.1	Simulation principle	165
9.2	Directional simulation	167
9.3	A class of useful directional simulation distributions *	171
9.4	Sensitivity factors*	178
9.5	Historical and bibliographical notes	180
10	LOAD COMBINATIONS	183
10.1	Ferry Borges-Castanheta load model	183
10.2	Rackwitz-Fiessler algorithm for absolutely continuous distribution functions	185
10.2.1	SORM correction	187
10.2.2	Accuracy verification	189
10.3	Clipped random variables as load pulse amplitudes	191
11	STATISTICAL UNCERTAINTY AND MODEL UNCERTAINTY	201
11.1	Introduction	201
11.2	Likelihood function. Sufficient statistics	202
11.3	Natural conjugate densities of the normal distribution	203
11.4	Experimental calibration of mathematical models*	215
11.5	Gradient angle estimation by uniform directional simulation on a cone	222
11.6	Historical and bibliographical notes	227

12 DECISION PHILOSOPHY	229
12.1 The decision problem	229
12.2 The von Neumann and Morgenstern axioms for preference ordering	233
12.3 Optimal reliability	239
12.4 Uncertain gain and utility functions	242
12.5 Influence from uncertain determination of the lottery probabilities	245
12.6 The engineering problem about the choice of utilities facing the phenomenon of risk aversion	246
12.7 Codified constraints	248
12.8 Multi-criteria decision analysis	248
12.9 Influence of radical errors*	250
12.10 Utility loss considerations	252
12.11 Examples of risk aversion modeling*	257
13 RELIABILITY OF EXISTING STRUCTURES	261
13.1 Information types for an existing structure	261
13.2 General system formulation for updating by use of relation information*	266
13.3 Decision criteria for existing structures*	278
13.4 Updating by revision of the limit state	282
13.5 Historical and bibliographical notes	282
14 SYSTEM-RELIABILITY ANALYSIS	285
14.1 Series systems and parallel systems	285
14.2 General systems. Cut sets and tie sets*	286
14.3 Influence on the definition of the limit state of the time variation of the input vari- ables	289
14.4 "Jury definitions" of the safe set	291
14.5 Ideal-plastic systems and ideal-brittle systems*	292
14.6 Historical and bibliographical notes	297
15 INTRODUCTION TO PROCESS DESCRIPTIONS	299
15.1 Processes. Gaussian processes. Poisson processes	299
15.2 Upper bound of the failure probability	301
15.3 Expected number of outcrossings	302
15.4 Determination of the expected number of outcrossings by directional simulation* .	306
15.5 Some simple load models of Poisson type	308
15.6 Historical and bibliographical notes	312

16 Appendix 1: CODE CALIBRATION	315
16.1 Principles of code calibration	315
16.2 Formulation of code optimization	316
16.2.1 Measure of fit	317
16.3 Design-value format	321
16.4 Sensitivity of the replacement vector δ in the design-value format*	329
16.5 Sensitivity of the partial safety factors in the design-value format*	329
17 Appendix 2: NATAF DISTRIBUTION	331
17.1 Correlation coefficients in Nataf distribution	331
18 Appendix 3: PROPOSAL FOR A CODE FOR THE DIRECT USE OF RELIABILITY METHODS IN STRUCTURAL DESIGN	337

Chapter 1

INTRODUCTION

1.1 Probabilistic and deterministic models

Probabilistic structural analysis is the art of formulating a mathematical model within which one can ask and get answer to the question: “What is the probability that a structure behaves in a specified way when given that one or more of its material properties or geometric dimensions and properties are of a random or incompletely known nature, and/or that the actions on the structure in some respects have random or incompletely known properties?”

Probabilistic structural analysis can be seen as a extension of deterministic structural analysis which is the art of formulating a mathematical model within which one can ask and get answer to the question: “How is a structure behaving when its material properties, geometric properties and actions all are uniquely given?”

Probabilistic analysis is an extension of deterministic analysis because deterministic quantities can be interpreted as random variables of a particular trivial nature. Their density functions are merely contractions to concentrated probability masses of size 1. If a deterministic model is treated as a probabilistic model, the answer to the question posed above about the probability will be either 0 or 1. If the answer is 1, the behavior specified in advance is just the answer to the question posed in the deterministic model. Since events of zero probability are without interest, one looks for the behavior that has probability 1 of occurring. This is equivalent to the problem of the deterministic analysis: “What dimensions should the structure be given in order that a specified behavior within the universe of the model is caused by a given action”.

Probabilistic structural design is a decision problem added to the probabilistic structural analysis. The question can be formulated in the following way: “What dimensions should be assigned to the structure in order that it has optimal properties in a given well-defined sense within the possibilities of the probabilistic model?” This question can be given the equivalent formulation: “What value should the probability of occurrence of a specified behavior be in order that the structure in a well-defined sense is optimally designed with respect to this behavior?”

Engineering judgment is the art of being able to decide whether results obtained from a structural analysis or design model is sufficiently realistic that the engineer dare base his or her practical decisions on these results. The formulation of a mathematical model is guided by the wish of getting a realistic description, of cause, but it is also necessary that the model becomes operational in

the sense that it is suited for solution, that is, that it can deliver answers to posed questions. An important aspect of the model formulation process is therefore the art of balancing realism against operability.

1.2 The safety problem

In this connection the question about the safety of structures makes up a particular type of problem. In order to appreciate the nature of this problem it is illustrative first to look at the problem in an experiment of thought in which the world behaves under total deterministic control. We imagine a project for a structure which relative to a given load configuration has carrying capacity properties that can be predicted down to the slightest detail. The specified load configuration contains a free parameter (termed the load parameter) which by its value fix the load level. The larger the load parameter, the larger the load level. Moreover we imagine that the planned structure has the following property. For any value of the load parameter it is possible to design the structure such that it will be exactly at the limit between the situation where the structure can carry the load and the situation where the structure fails in some sense. If the considered load configuration with certainty is the only one the structure will experience, and the future maximal value of the load parameter is known with certainty then, of course, it will be sufficiently safe to design the structure such that the limit situation just exactly does not occur for the maximal value of the load parameter.

It is obvious that any doubt about the value of the maximal load parameter or any doubt about the carrying capacity of the structure as expressed by the load parameter value in the limit situation (the ultimate load value) raises a question about safety. Even within the deterministic world of this supposition the doubt in the mind of the engineer of his or her knowledge about the exact parameter values causes a safety problem: How much larger than the maximal load parameter - assessed according to the best conviction - should the ultimate load value be chosen in the carrying capacity model in order that the engineer can guarantee that the structure will not fail under service or, at least, that there is an extremely small risk that a failure will occur. The difference between the two values is called the safety margin.

The nature of the problem is such that it cannot be answered solely by theoretical considerations. The accumulated experiences of the profession of master builders of old days and, later, of the engineering profession obtained from practicing the art of engineering must necessarily make up the basis for value assessment of safety margins. On the other hand, it is clear that the variety of structures is so large that there is a need for structuring of the information, that is, for rational analysis and description of these experiences.

The reaction of the society on experienced occurrences of failure will in principle reveal whether or not the engineering profession has been too daring in its assessment of what are considered to be needed safety margin levels. At the same time the need for economical compatibility and also the general resistance against waste of resources counteract a tendency of the profession to be too cautious.

All together, in order to be able to aim at optimal decision making a rationally structured model tool must be at hand, possibly not always for each individual engineer who can lean against an authorized formal set of rules, but for the engineering professions as an entity. This model

tool must contain elements that allow quantification of different uncertainty types. In our thought experiment the uncertainties are of the special kind that characterize the doubt in the mind of the engineer about own knowledge about the exact values of the ultimate load value and the maximal value of the load parameter. Quantification of such uncertainties can be philosophically debatable from a usual scientific objectivity point of view. Never the less, it is the human power of judgment beyond scientific explanation which is the pillar on which all human activity is built. The theory of structural reliability must necessarily be built on the assumption that the engineering performance of professional judgment through experience and training can be reflected within a formal model universe. The model formulation ought to be adaptive in the sense that it can fit the possibilities of the engineer to exercise reasonable judgments and evaluations. Reversely the engineer must adapt his or her way of thinking to the language of the model. Simultaneously the model gradually changes its status from being a more or less arbitrary system of formulation with less objective value assessments to a system which is well suited for processing and transmitting of essential engineering information.

1.3 Formal systems of judgment evaluation

There are many formal systems, often mathematical of appearance, that can be used as support for exercising judgment evaluations and processing of these evaluations. The simplest and most wide spread system is the grading system of students. For this system the mathematical model formulation consists in the extreme simplification that the universe of human qualities is supposed to have such properties that it can be mapped as grades on one and the same arithmetical scale. Moreover, it is often supposed that the rules of the algebra can be used of averaging over incommensurable qualities with the purpose of characterizing the entity of qualities by a single or some few numbers. From a scientific point of view this model seems to be highly debatable. Never the less, the experience shows that in spite of obvious shortcomings and injustice the practical application of the grading system mirrors at least some of a person's qualities making the grading usable for many purposes. The explanation is that the system is adaptive. It functions in the same way as a language. If the system contains rules that are too rigid to be adaptive, the system is changed to a larger degree of flexibility. In spite of obvious scientific shortcomings the use of the system gives a better processing and transfer of information compared to what is achieved without use of any system whatsoever.

It seems to be easy to accept that grading statements with imprecise meaning are applicable on phenomena that in their nature are complex and far away from so-called scientifically exact phenomena. Sometimes it is considered unscientific to assess by judgment or guess about natural scientific phenomena with the purpose of letting these guesses be usable or even valuable information in decision processes concerning technical matters. This perception of unscientific behavior in the decision making is peculiar in view of the common belief that the technically-scientific fields have a less complex structure than in most other fields of human thinking and activity. Therefore the evaluation model for technical decisions should be more trustworthy. As a matter of fact there is, all things considered, a substantial difference between ideal-scientific perception and practice. A simple example in the technical field is the use of tolerance specifications for geometric measures of building components.

1.4 The tolerance system

When a geometric measure B of a building component is accompanied by a tolerance specification T it is thereby usually meant that it is required that the measure of the component should be within the interval $[B - T/2, B + T/2]$. Whether or not the requirement is satisfied for a given building element can be controlled with a large degree of confidence by measurement, of course. However, it is rare that all produced components of a given type at the factory are subject to control measurements with the purpose of rejecting elements that do not satisfy one or more of the tolerance specifications. Such a total control is resource demanding and moreover it is not necessary. Rather the point of view is held that the production of components with respect to measure accuracy should be made with such a care that the tolerance requirements only rarely are violated. On the other hand, the work process should not be refined to such a degree that the measures are unnecessary accurate in particular if the cost of obtaining such accuracy is significant. With this point of view in mind the tolerance requirement becomes an adaptive tool of control for the production process. Thus the tolerance specification becomes analogous to a grading. It is a label that point at the category of quality corresponding to a specific class of production methods rather than an exact bounding of the geometric measures. Since the fulfillment of the requirement can be tested by measurement, it will, of course, in situations of claims, work as an exact concept. However, usually claims only occur if the use of the building component causes essential problems in the process of assembly. Often components with measures outside the tolerance interval will never be identified.

It is natural to use the concepts from the probability calculus for the description of the properties with respect to accuracy of a production method. By measurement of suitably large samples of items from the production clear data can be obtained without difficulties of principle. In the form of histograms or cumulative curves the set of data directly gives information about the frequency of the occurrence of different measures. The professional judgment exercised by the production manager of whether or not a given production process is out of control with respect to the given tolerance specification can be supported on the measurements. However, his or her experience helps to support the judgment on several not necessarily quantitative indicators.

1.5 Interpretation of the concept of probability

Within more recent time formal mathematical languages different from the probability formalism have been developed for the purpose of expressing judgment evaluations and their processing. These are languages that work with degrees of truth (“fuzzy logics”) or degrees of membership of a set (“fuzzy set theory”). These systems of evaluation seem to have a certain success in particular within the so-called soft sciences (“non-exact” scientific disciplines). Attempts have been made to apply these tools also within the type of problems that concern structural reliability. The dominating opinion is, however, that the probability calculus is the most convenient mathematical basis for evaluation of the reliability of structures. One reason is that the mathematical theory of probability allows different for the applications equally useful but never the less very different interpretations of what a probability means. In the tolerance example it was explained that the concept of probability can be used to model the frequency by which a specified event can be expected

to occur by a large number of repetitions under controlled circumstances. This is the so-called relative frequency interpretation of probability. It is obvious that the structural reliability analysis must consider the unavoidable and ubiquitous random fluctuations of the material properties, the geometric measures and the loads. These fluctuations are more or less describable in the form of histograms or cumulative curves based on measured data. Thus they are describable in terms of probabilities interpreted as relative frequencies. They make up an element of uncertainty of physical kind on top of the uncertainty attached to the engineer's knowledge about the structure. By the inclusion of this physical uncertainty element in the deterministic model of our supposition above it changes the model from being deterministic to be probabilistic.

However, the probability theory is also interpretable as a system of calculus for professional judgment in which the probabilities express degrees of belief of whether or not specified events occur or whether or not posed statements are true. If we return to our supposition with the deterministic model, we may imagine that the engineer possesses sufficient professional experience to be able to judge not just whether his or her carrying capacity model gives a result that deviates from the exact carrying capacity but also to give a more or less precise quantitative evaluation of the deviation. As an example such an evaluation could be that the engineer assesses an interval and an associated probability that it is a true statement that the exact value is in the assessed interval. In more detail, he or she may assess the probability that the exact value is larger than the upper interval border and the probability that the exact value is less than the lower interval border.

Such probabilities can be interpreted as measures of the degree of belief or knowledge of the engineer about the truth of his or her statement. From a physical point of view these probabilities are not interpretable as relative frequencies. On the other hand, it may support the considerations about the probability assessments to think of these probabilities as if they are relative frequencies in a supposed experiment. He or she can use analogies with situations in which relative frequencies are at hand or he or she may conglomerate his or her experiences (or rather the reported experiences of the engineering profession) from many different structures in order to reach an evaluation of the frequency by which he or she thinks to be right about the statement.

An alternative form of the judgment is to express it by a mean value, a standard deviation and another quantity, possibly, that expresses skewness. Skewness is a quantitative measure of more weight on the belief that the exact value rather is on the one side of the mean value than on the other side.

It is indicated above that this judgment process is a problem for the individual practicing engineer if it should be based on own experiences. In practice guidance should be found in existing recommendations worked out by a code making authority. This authority is supposed to represent the profession and to be competent and qualified to conglomerate the experiences of the profession. The quantification of judgment uncertainties should be given explicitly or implicitly in the code of practice that regulates the level of reliability of structures designed in practice.

Besides the two mentioned types of uncertainties there are other important types of uncertainties with associated interpretations of the probabilities that quantify the uncertainties. A more detailed discussion is given in Chapter 3.

1.6 Compatibility of the probability interpretations

In spite of the different interpretations of the probability concept it always allows a supposition in which one can imagine situations of repetitions. This gives a mental basis for an interpretation of the content of information in a probability statement. In this respect the mathematical probability concept has an advantage as a model of judgment evaluation relative to other models as for example “fuzzy set theory”.

Another philosophically important and uniting aspect is that it can be shown that the probability theory in decision situations is superior to all other evaluation models when these decision situations concern games with gain rules of a specifically simple but commonly relevant type. The superiority of the probability theory is due to the property that a gambler who applies a game strategy which is based consistently on the rules of probability calculus in the long run will take the gain from any opponent gambler that does not follow these rules. This property is interesting for the choice of the basis for a theory about structural reliability because the decision methods in the structural design process can be seen as a game strategy in a game against the nature.

A probabilistic model for structural reliability must necessarily mix probabilities with seemingly different possible interpretations. Objections of philosophical kind have been raised and are still raised against such mixing claiming that they are not allowable because probabilities of different interpretations are incommensurable. It is a general experience that it is almost always difficult to reach general consensus about the clarification of philosophical problems. However, it has often been experienced that methods claimed to be philosophically doubtful have turned out to be quite useful for the solution of practical decision problems. The methods have through their use gained such a meaning and objectivity as decision tools that the philosophical problems have vanished. The methods become acceptable because they have turned out to be useful.

The philosophical problem about mixing of “different types” of probabilities may be solved, possibly, for some of the skeptical readers if they accept the solution of a specific reliability evaluation problem as the exercise of a supposition that in a rational way compares and summarizes all the uncertainties that the engineer imagines can affect the reliability of the structure. In this supposition all the probabilities are considered as representatives for relative frequencies. Some of these may be based on data from repeated measurements while others are generated by a mental process as in the previously considered suppositions. The structural reliability is then evaluated by a study of the properties of this supposed game of the mind.

Another way of thinking is to imagine all the probabilities of the model to be personalistic probabilities, that is, the evaluating engineer’s degrees of belief in the truth of his or her statements. It has no influence on the reliability model from where the engineer gets his or her value assessments. Some assessments are based on precise statistical analyses of measured data, possibly, while other assessments are professional estimates. The information gathering of the engineer just leads to the input values of the personalistic quantities needed in the reliability model in order that it can deliver those quantitative values that express the degree of the structural reliability as it is to the conviction of the engineer in dependence of his or her knowledge. Thus all input values become of the personalistic type and they will vary among different engineers that try to make a reliability analysis of the same structure. Those input values that are based on measured data will just be reproducible from engineer to engineer to a larger degree than the input values that

fundamentally are based on the judgments of the individual engineer.

1.7 Knowledge related nature of the reliability measure

It follows from this discussion that a computed quantitative measure of the reliability of a structure cannot be interpreted as a number that solely characterizes a physical property of the structure. Rather the reliability measure resulting from given knowledge should be interpreted as a measure of the overall quality of this knowledge about factors that are of importance for the judgment of the properties of the structure with respect to reliability. If the engineer gathers more information and takes it into account, the reliability measure will change in general. The measure may change against smaller reliability if the extra information is about unfortunate not earlier known properties, or the extra information may increase the reliability. It will be demonstrated in a later chapter that extra information even being bad news can increase the reliability. This at a first glance surprising property of the reliability model is due to the fact that lack of information often can imply larger uncertainty about the properties of the structure and thus about its reliability than sure information about less good properties.

Updating of the reliability measure is actual by reevaluation of the reliability of an existing structure. Such a reevaluation may have the purpose to help judging whether or not a reinforcement of the structure is needed in connection with a changed use of the structure or due to the wear and deterioration that has taken place since the structure was new. Simultaneously the updating serves the purpose of establishing a decision basis for the design of the reinforcement in case it is needed.

1.8 Ambiguity problem

It is possible to formulate many different probabilistic models for the evaluation of the reliability of a structure. These models may be more or less elaborated in their detailing and therefore be more or less flexible with respect to handling new information. It is common to all probabilistic reliability models that the measure of reliability with respect to not experiencing some specified adverse behavior is uniquely related to the probability that the adverse behavior will take place within a specified time interval as, for example, the assumed time of existence of the structure (the design life time). This probability is denoted as the probability of failure. The word “failure” is here only a label on the event that in a given connection is defined to be adverse behavior.

For example, in some connection failure may be defined as a genuine collapse and in another connection be defined as displacements above some given thresholds. For the same structure, the same definition of failure and the same information about the structure it is the ideal, of course, that different models that are not in obvious conflict with the given information by and large give the same value of the failure probability. However, this ideal turns out to be difficult to maintain and the more difficult so the less the failure probability.

If from any reasonable conception the failure event can be characterized as a rare event – which usually is the case for structures in practice – a rational probabilistic reliability model should be constructed such that it assigns a small probability to the failure event. This is a necessary

requirement in order to maintain the mental interpretation of the probability as a relative frequency. Therefore the sensitivity to the choice of model is a problem that cannot be avoided when making the rules for rational judgment of the reliability of structures. The problem is analogous to the problems faced in connection with strength testing of materials and also in connection with several experimental testing methods. The results can only be compared if they are produced by the same testing method. This fact is the reason that a large number of testing methods have been standardized.

In order to be able to compare failure probabilities computed for different structural layouts and different failure definitions all on the basis of given information it is thus necessary that all quantities are computed within the same probabilistic model. This requirement will be respected by any rationally thinking engineer who in his or her design work necessarily makes such comparisons. However, the engineer is left over with a decision problem: Which value should the reliability measure be given in order that the structure just accurately can be considered to possess sufficient reliability with respect to the specified failure event? The reliability measure can be changed to the one or the other side by changing the dimensions of the structure or by changing its layout. Where should the engineer fix the value? For the individual engineer the answer is given in a set of rules worked out by the profession with the accept of the society, that is, a code of practice which is made by a superior evaluation of the problem. Before giving a description of the current codes of practice the nature of the problem will be analyzed somewhat more closely.

1.9 Determination of the reliability level by optimization

The problem about the choice of the reliability level can be analyzed by the aid of decision theoretical methods. However, these methods do not solve the problem but transform it to a more clearly interpretable optimization problem which balances costs and gains against each other. By this the problem is changed from a problem of choice of a target value of the safety measure to the choice of cost values associated to the failure event. Since some types of failure events can imply the loss of human lives or be fatal with respect to their consequences for the society, it can not in general be left to the individual practicing engineer to make the value assessments that are necessary for the decision process. As mentioned such value assessments are a matter for the entire engineering profession or rather, possibly, the entire society. The values should directly or indirectly be given in codes of practice for the profession. Due to the sensitivity with respect to the choice of the model it is obvious that the cost values cannot be chosen independently of the probabilistic reliability model used for the analysis unless it is accepted that the dimensions of the resulting structure varies from model to model. If none of the models are in obvious conflict with the available information, it seems difficult to find arguments by which the one model should be chosen rather than the other model.

1.10 Consequence-calculation principle governing the development of the codes

In the past the code formulation work has followed a completely different line of reasoning than the presented philosophy suggests. The code work has its roots in a step by step historical development with returning revisions during the last 50-100 years. Naturally the argumentation has been within the framework of thinking about the reliability problem that has been accepted practice at the time when the revision work was made. Quantitative probabilistic models were not within this framework. Probabilistic arguments of qualitative type were more or less in the debate, however, and they could affect the value assessments. Essentially the basis was a step-by-step cautious change of the value assessments at each new revision of the code - now and then in connection with a change not just of the values but also of the format of the code.

The value assessments in the first codes were based on a formalization of practical rules originating from the traditions of craftsmanship as they have been developing up through the times by the master builders. The essential argument was that the traditions of craftsmanship were results of slowly gained experiences about in which way good and safe structures should be designed. This accumulation of experiences was the necessary basis for a formalized engineering practice that in steadily increasing extent by application of mathematical models could deviate from traditional structural solutions by cautious use of the insight that the development of the natural sciences brought about. It was clear to the code makers that mathematical models give idealized pictures of the reality and that it is difficult to guarantee that all phenomena of possible essential importance for the reliability are included or realistically represented in the models. To this the history showed too many cases of mistakes having more or less catastrophic consequences. Therefore the code was made such that its value assessments were belonging to a selected class of deterministic and suitably simple models of the behavior of structures, all well known from the engineering education. Within the defined model universe the values of one or more so-called safety factors could then be assessed by consequence computations. Safety factors are nothing but dimensionless equivalents to safety margins (ratios instead of differences). These consequence computations served the purpose to show that the use of the given safety factor values in usual engineering computations resulted in the same structural dimensions as obtained from the craftsmanship rules. With the increased degree of problem structuring and understanding of the phenomena brought about by the mathematical model analysis it became possible slowly to change the value assessment in a controlled way such that more daring design of structures became possible.

Increasing insight with associated new models and an increasingly broader fan of available information has occasionally caused a change of the code format in direction of increase of shading. In this entire sequence of revisions the consequence computation principle has been a governing element. Whenever the code was given a new format together with the necessary value assessments, it was required that the new code by and large leads to the same dimensions as the old code for some examples of typical structures to be covered by the code. The change of code thus gave an initial situation for future more shaded revisions without breaking the continuity of current practice of what should be good and safe structural dimensions.

1.11 Optimality postulate

By the introduction of a code that specifies the value assessments for use in a probabilistic reliability model the problem should be handled in the same way. It is the existing structures designed according to the current codes and practice that specifically show where the reliability level is as it is presently accepted by society. It can reasonably be claimed that society by its accept of current practice of design implicitly has assessed the costs associated to the failure event such that the current design rules at present are close to be optimal. It not so there would be a need for revision of the value assessments of the code. If this point of view is taken as a usable postulate, it is possible to compute the cost of failure for each existing structure and each probabilistic model . Both this cost and the corresponding optimal failure probability will vary with respect to the applied probabilistic model and the considered structure example but alternative models obviously give the same dimensions for the same structure example.

It follows from this discussion that a probabilistic code necessarily must standardize at least those elements of the probabilistic models that otherwise by different arbitrary choices without clear conflict with the given information lead to groundless variations of the results. The code could after such standardization specify the costs of different relevant types of failures with associated consequences. This corresponds to a code that allows the most structured decision procedure based on optimization. A simpler but also more rigid code is obtained if only acceptable values of the reliability measure are specified. A code like that may in a weak sense take care of the optimality point of view by specifying different acceptable values of the safety measure corresponding to different classes of more or less serious consequences. These so-called safety classes can in their simplest form be verbally characterized such that the acceptable value of the reliability measure increases over classes with increasing seriousness of the consequences.

In order that a code committee in a reasonably rational way can be able to assess the acceptable values of the reliability measures in the different safety classes within a standardized probabilistic model universe, the code committee must lean against consequence computations using the posed postulate about optimal dimensioning practice. The result is a probabilistic code of the rigid type with respect to optimization. On the other hand, such a code is in some essential features much closer to the format of most current codes of practice. The probabilistic code is therefore well suited as a basis for running revisions at the safety factor values in current codes in pace with increased common information and insight.

1.12 The following chapters

Next chapter explains the formal rules for obtaining officially required reliability as contained in the current Danish code. The rules imply that all computations in principle take place within models of deterministic form but the value assessments are to some extent based on probabilistic arguments.

The following chapters develop a probabilistic code format by a step by step introduction of as few necessary concepts and variables as possible for obtaining a formal reliability evaluation system that catches the most essential features of the nature of the uncertainties and their interplay.

Such a line of model development is characterized by the property that simple and therefore less information demanding models come before more structured models. This is not solely of pedagogical reasons but just as essentially due to other reasons. One of these is that lack of detailed information implies that judgment quantities play an essential role in realistic reliability evaluations. The nature of the associated uncertainties and their treatment can hardly carry more than the simplest possible pragmatically chosen structure which is consistent with the superior model. (The word “pragmatic” has the meaning here that the model choice should be convenient from a mathematically operational point of view but also that it should be well suited for quantification of professional judgments).

1.13 Epilogue

Once in a while the engineering profession needs to analyze the basis for its decision tools. Do we as engineers act in an objective and rational way? The previous pages of text present an attempt to discuss some important issues of this question which will be picked up again at the end of Chapter 3: “Probabilistic Information”. In 1975 one of the pioneers in the field of applications of probabilistic methods in structural reliability C.A. Cornell gave the following answer [1.1]: “... Maybe, in fact, we don’t know as engineers how to deal with “too much” realism in our models. Rather, perhaps progress is no more than a continuous refinement of operational procedures (“rules for a game”) that capture just enough reality to protect the public and profession from low quality practice, on one hand, and, on the other, to be supportive of the competent engineering designer who wants to check himself or to roughly calibrate his new design relative to others where we have experience.”

Bibliography

[1.1] C.A. Cornell (1975) Some comments on second-moment codes and on Bayesian methods. In: A.M. Freudenthal, M. Shinozuka, I. Konishi and T. Kanazawa (eds.), *Reliability Approach in Structural Engineering*, Maruzen, Tokyo.

This page is intentionally left blank.

Chapter 2

PARTIAL SAFETY FACTOR METHOD

2.1 Limit states

The concept of limit state related to a specified requirement is defined as a state of the structure including its loads at which the structure is just on the point of not satisfying the requirement.

Often the requirement is verbally formulated. However, usually the requirement will be interpreted and formulated within a mathematical model for the geometric and mechanical properties of the structure and for the actions on the structure. Let x_1, x_2, \dots, x_n be those variables that independently contribute to that part of the mathematical model that concerns geometry, strength properties and actions. The variables are free in the sense that their values can be chosen freely and independently within a given subset of the n -dimensional space \mathbb{R}^n . This subset is the domain of definition of the model in the same way as a function of n variables has a domain of definition. To each choice of values corresponds a uniquely defined structure with uniquely defined loads. This structure with its loads is a pure mathematical object that does or does not satisfy a given limit state requirement. Possibly it cannot at all be realized as a physical object, for example because the load exceeds the carrying capacity of the structure.

Example 2.1 Consider the very simple structure that consist of a rope fixed to a hook and carrying a burden. If the hook is supposed to be much stronger than the rope we have a reliability problem that corresponds to the requirement that the rope should be able to carry the burden. This problem can be formulated in terms of two free variables, the tensile strength r of the rope and the weight s of the burden. Both these quantities are positive per definition. Thus the domain of definition of the model is the subset \mathbb{R}_+^2 of \mathbb{R}^2 .

Clearly this rope structure with its load cannot be realized as a physical object if r and s are chosen such that $r < s$. Nevertheless we let the entire \mathbb{R}_+^2 be the domain of definition for the structure considered as a mathematical object. If the mathematical model is extended by a geometric variable a for the cross-section area of the rope, we calculate the stress in the rope as s/a independent of the value of r . Moreover, if the model is extended by Hooke's law and with a length l of the rope, we can calculate the resulting displacement of the burden when its weight is transferred gradually to the rope under the assumption that the hook is completely rigid. The displacement becomes $ls/(aE)$ where E is the elasticity coefficient. Hooke's "law" expresses that

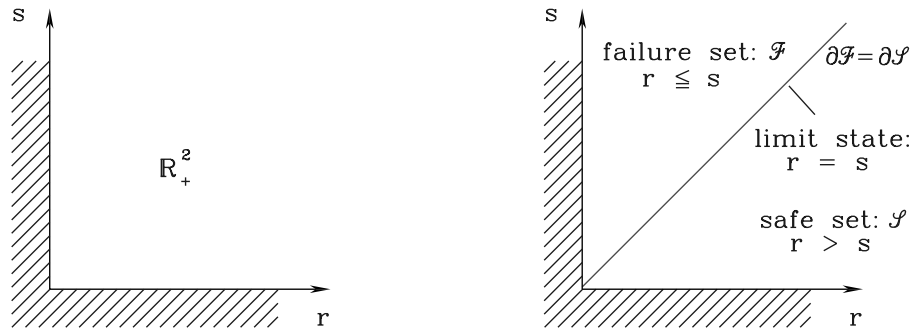

Figure 2.1: Domain of definition and failure limit state of a reliability analysis model for a rope that carries a load.

the relative elongation (the strain) of the rope is proportional to the stress in the rope.

An analysis of a reliability problem with simultaneous consideration of the requirement that the rope should be able to carry the burden and the requirement that the displacement should not be larger than a given value δ thus becomes formulated in terms of the 5 variables a, l, E, r, s , which per definition all are positive. Thus the domain of definition of the extended model is \mathbb{R}^5 . \square

Here we have assumed that the reliability problem can be formulated in terms of a finite number of variables x_1, \dots, x_n . There are relevant reliability problems where the model formulation most conveniently requires use of an infinity of variables (functions). In particular this is the case when random temporal and spatial property variations of actions and resistances are relevant. However, this first part of the reliability theory for structures will almost exclusively deal with models of the simple type characterized by a finite number of input variables x_1, \dots, x_n .

A given limit-state requirement divides the domain of definition of the model in two sets, the safe set and the failure set, in which the requirement is satisfied and not satisfied, respectively. The boundary of the safe set (which, of course, is also the boundary of the failure set) is called the limit state. In the models considered herein the limit state is of sufficiently simple structure to be represented as the set of zero points for a piecewise differentiable function $g(x_1, \dots, x_n)$ which is defined everywhere in the domain of definition of the model and which takes positive values in the internal of the safe set and negative values in the internal of the failure set. Moreover, if the safe set is simply connected we say that the limit state is regular. Thus the limit state is given as the set of values of the input variables (x_1, \dots, x_n) for which

$$g(x_1, \dots, x_n) = 0 \quad (2.1.1)$$

It is emphasized that the choice of g is not unique. For example, the function g^3 can be used in place of g in (2.1.1). Parts of or all of the limit state can be chosen to belong to the failure set or to the safe set according to what in a given problem may be considered convenient.

Limit states can be of different categories. The principal categories are collapse limit states (ultimate limit states) and serviceability limit states. A collapse limit state usually represents a situation where the structure is just at the point of loosing its integrity, that is, to pass into an irreversible state that may have a catastrophic nature and from which the structure only recovers by repair or reconstruction. A serviceability limit-state corresponds to the limit between an acceptable

and a not acceptable state under normal use. Such a state is with respect to direct damage of the structure often reversible in the sense that the structure by unloading passes unchanged back to the safe set. However, passages of a serviceability limit-state can also cause permanent damages of the structure such as formation of cracks or other visible defects. Generally these damages will not raise a reliability problem of the collapse limit-state category provided the structure is subject to general running maintenance.

Example 2.2 The collapse limit-state for the rope in Example 2.1 is given by the zero points of the function

$$g(r, s) = r - s \quad (2.1.2)$$

Thus the collapse limit state is given by $r = s$, the failure set by $r \leq s$ and the safe set by $r > s$, see Figure 2.1.

The requirement that the displacement of the burden at most is a given value δ is of the category as a serviceability limit state. The function g can here be chosen as

$$g(a, l, E, r, s) = \delta aE - ls \quad (2.1.3)$$

Thus the serviceability limit-state is given by $\delta aE = ls$, the failure set by $\delta aE < ls$ and the safe set by $\delta aE > ls$.

In the reliability analysis the two limit states of different category will be considered separately. The situation is different if two or more different collapse limit-states can be of importance. In Example 2.1 it was assumed that the carrying capacity of the hook was much larger than the carrying capacity of the rope. If this assumption cannot be maintained we must introduce yet another variable r_k for the carrying capacity of the hook. Let r_t be the carrying capacity of the rope. Then we have a composite collapse limit-state that can be defined as the zero points of the function

$$g(r_k, r_t, s) = \min\{r_k, r_t\} - s \quad (2.1.4)$$

The safe set is the intersection of the two sets given by $r_k > s$ and $r_t > s$ while the failure set is the union of the two sets given by $r_k \leq s$ and $r_t \leq s$. The limit state is given by $\min\{r_k, r_t\} = s$, see Fig. 2.2. \square

Under the specified differentiability conditions for the function g and for $n = 3$ the equation (2.1.1) obviously defines a piecewise differentiable surface. The limit state is therefore more specifically denoted as the limit-state surface or the failure surface. Of practical reasons these terminologies are used for any n . Typically the piecewise differentiability enters the problem in situations as in (2.1.4) where more physically different possibilities are relevant.

Among the regular limit-state problems those with convex safe sets make a particularly simple class that most often is the relevant one in practice. Per definition a convex set is a set with the property that all points of the straight line piece between any two points of the set are in the set. In other words, if two structures of a given type are represented by points within a convex safe set, then any structure designed by linear interpolation (proportioning) between the two structures is also a safe structure. In particular the convex limit-state problems are suited for application of the

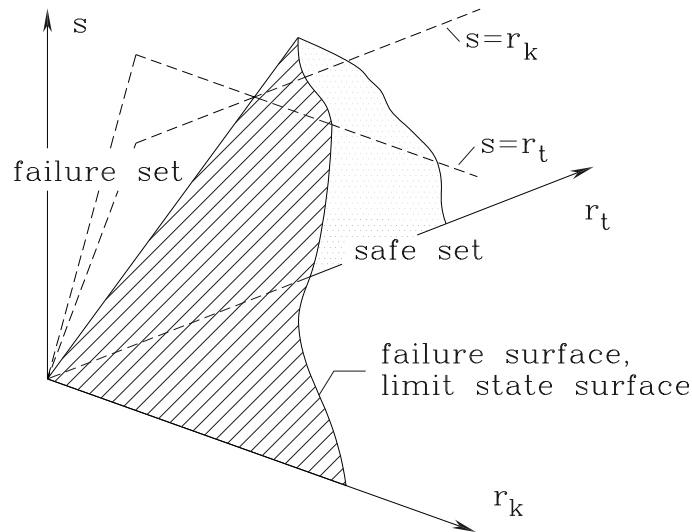

Figure 2.2: Composite collapse limit state for a rope fastened to a hook and carrying a burden.

deterministic method of ensuring safety known as the partial safety factor method. This method is authorized in the present Danish codes as well as in the present codes of many countries. The European code is also based on the partial safety factor method for ensuring an authorized safety level.

2.2 The safety factor concept and the requirement of formulation invariance*

The safety documentation for a structure has earlier often been based on the ratio between a calculated carrying capacity r (resistance) and a corresponding load effect s (stress). This ratio

$$n = r/s \quad (2.2.1)$$

was called the safety factor. Since $n > 1$ if and only if $r > s$, the statement $n > 1$ tells that the structure corresponds to a point in the safe set while the statement $n \leq 1$ tells that the structure corresponds to a point in the failure set. At a first glance one can get the impression that the size of n is a measure of the safety. Naturally, for a given definition of r and thus also of s an increase of n will reflect an increased safety given that $n > 1$. However, it should be noted that the safety factor depends on how the resistance r is defined. For example, one could just as well consider the ratio $r^3/s^3 = n^3$ as a safety factor. Possibly one might claim that there is a "natural" definition of r in a "natural" physical dimension. This claim cannot withstand a closer investigation. The following example illustrates this.

Example 2.3 Let r be the bending resistance of a reinforced concrete cross-section in a plane beam subject to a compression normal force N and a bending moment s . The internal forces are referred to a given axis in distance a from the reinforcement, see Fig. 2.3. However, the choice of

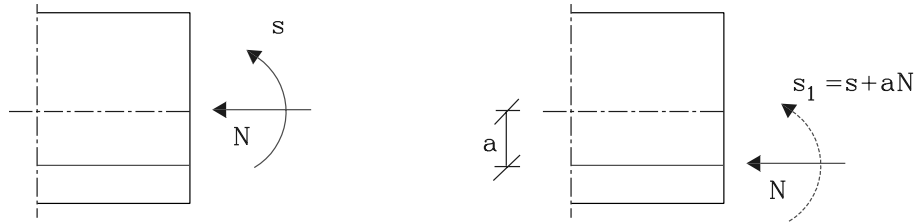

Figure 2.3: Two different representations of the internal forces in a plane reinforced concrete beam illustrate the formulation invariance problem.

this axis is arbitrary. A natural choice is an axis through the geometric center of the cross-section. Just as natural a choice is an axis through the center of the reinforcement. If the bending moment caused by the action on the beam is s when referred to the axis in the distance a , then the bending moment with respect to the axis at the reinforcement is given by $s_1 = s + aN$. The safety factor (2.2.1) can therefore be written as

$$n = \frac{r_1 - aN}{s_1 - aN} \quad (2.2.2)$$

where $r_1 = r + aN$ is the resistance with which $s_1 = s + aN$ must be compared. From (2.2.2) it is seen that if $n > 1$ for some choice of a then $n > 1$ for all a . However, the safety factor can take all values in the open interval from 1 (for $a \rightarrow \pm\infty$) to ∞ (for $a = s_1/N$). Only the value $n = 1$ is invariant with respect to a . This corresponds to the fact that the limit state is given by the equation

$$g(r, s) = \frac{r}{s} - 1 = 0 \quad (2.2.3)$$

Naturally the corresponding failure surface is independent of a . □

The arbitrary nature of the definition of the resistance r and the consequence of this that the safety factor has an arbitrary value makes value specifications difficult to handle in the context of codes. Necessarily a specification of the safety factor n must be accompanied by specifications of the formulas for the resistance that correspond to the specified safety factor. However, it is highly inconvenient if the code is required to be formulated on such a level of detailing both because it easily will lead to confusion and lack of theoretical clearness and because it will deadlock the development and application of improved or more universal theoretical models in structural mechanics. Thus it is a well motivated requirement that the safety specifications of the codes become independent of arbitrary equivalent formulations of resistances and corresponding action effects. Of course, these quantities are output variables chosen primarily under consideration of mathematical convenience. For certain types of reliability analysis problems it is even so that a resistance is not definable in a clear way by a single scalar quantity. In particular this is seen in soil mechanical problems. The requirement discussed above can be expressed by saying that the safety system of the code must be formulation invariant.

2.3 Probability considerations concerning the safety factor*

In a probabilistic formulation the safety factor (2.2.1) is a random variable

$$N = R/S \quad (2.3.1)$$

where R and S are random variables corresponding to the chosen resistance definition. The probability that the structure is not failing is then

$$P(N > 1) = P(R > S) \quad (2.3.2)$$

Contrary to the safety factor itself this probability is invariant with respect to the definition of R . Of course it is required that all considered resistance definitions with respect to a given limit state and corresponding action effects are defined in one and the same probability space.

Example 2.4 Let us assume that R and S are mutually independent and distributed according to the normal distribution with parameters (μ_R, σ_R) and (μ_S, σ_S) , respectively. (μ = mean value, σ^2 = variance). Then

$$P(N > 1) = P(S - R < 0) = \Phi \left(\frac{\mu_R - \mu_S}{\sqrt{\sigma_R^2 + \sigma_S^2}} \right) \quad (2.3.3)$$

where Φ is the distribution function of the standardized normal distribution. This result follows from the fact that the difference between two jointly normally distributed variables is normally distributed. If this choice of model has been made, it is naturally not justified by an alternative choice of resistance definition to assume that the alternative resistance and action effect are mutually independent and normally distributed. Here the requirement about formulation invariance shows up in another appearance. Distributional assumptions about R and S depend on the chosen definition of R . Therefore a probabilistic code cannot be formulated on the basis of output variables as R and S . \square

On the basis of (2.3.1) a so-called *central safety factor* n_c can be defined by

$$n_c = \frac{E[R]}{E[S]} \quad (2.3.4)$$

where $E[\cdot]$ is the mean value (expectation). It is noted that n_c is not the same as $E[N]$, see Example 2.5. A more general safety factor is

$$n_{p,q} = r_p / s_q \quad (2.3.5)$$

which is based on chosen fractile values r_p, s_q for R and S defined by, see Fig. 2.4,

$$P(R < r_p) = p \quad (2.3.6)$$

$$P(S < s_q) = q \quad (2.3.7)$$

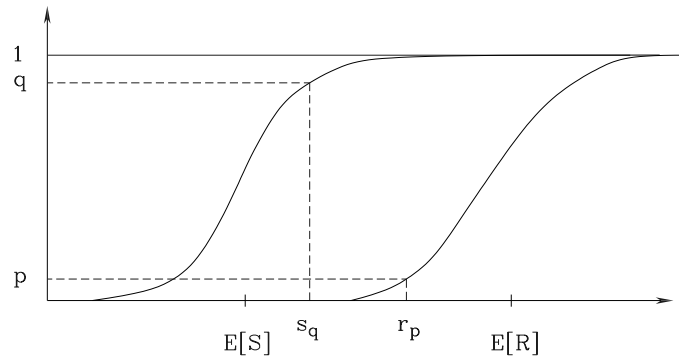
Figure 2.4: Distribution functions with fractile values for R and S .

Example 2.5 If R and S are assumed to be normally distributed as in Example 2.4, we get

$$n_c = \mu_R / \mu_S \quad (2.3.8)$$

while $E[N]$ does not exist. (This is a consequence of the fact that S has a positive probability density in any neighborhood of zero). Moreover we have

$$n_{p,q} = \frac{\mu_R + k_p \sigma_R}{\mu_S + k_q \sigma_S} = n_c \frac{1 - k_{1-p} V_R}{1 + k_q V_S} \quad (2.3.9)$$

where $V_R = \sigma_R / \mu_R$, $V_S = \sigma_S / \mu_S$ are the coefficients of variation for R and S , respectively, and where k_p is defined by $\Phi(k_p) = p$ (and correspondingly for k_q). Assume now that the structure is designed such that (2.3.3) takes a given value $1 - p_f$, that is, such that

$$\frac{\mu_R - \mu_S}{\sqrt{\sigma_R^2 + \sigma_S^2}} = \beta \quad (2.3.10)$$

where $\Phi(-\beta) = p_f$ is the failure probability. After some algebra the central safety factor n_c can then be expressed by β through the formula

$$n_c = \frac{1 + \beta \sqrt{V_R^2 + V_S^2 - \beta^2 V_R^2 V_S^2}}{1 - \beta^2 V_R^2} \quad (2.3.11)$$

It is noted that $n_c \rightarrow \infty$ as $V_R \rightarrow 1/\beta$. From this it follows that the structure cannot be designed to have the failure probability p_f that corresponds to β if $V_R \geq 1/\beta$. However, this is due to a model error of physical inconsistency type. The error is that the normal distribution assigns a positive probability to the event $R < 0$. For suitably small values of V_R the error has no importance but the model loses its applicability for values of V_R or β for which V_R is not considerably less than $1/\beta$. A typical choice of order of size for β will be 4 or 5. The normal distribution model for R is therefore hardly reasonable for V_R larger than about $0.15 \approx 1/6.7$.

The large variation of n_c with V_R and V_S for given β (for $\beta = 4$ we have $n_c = 1, 1.84, 2.76$ for $V_R = V_S = 0, 0.1, 0.15$, respectively) illustrates the inconvenience of using the central safety factor

for value assignments in a code that as an ideal tries to keep control on the value of β and thus on the failure probability within a given safety class.

If n_c given by (2.3.11) is substituted into (2.3.9) we get

$$n_{p,q} = \frac{1 - k_{1-p} V_R}{1 - \beta V_R} \frac{1 + \beta V_S \sqrt{1 + (V_R/V_S)^2 - \beta^2 V_R^2}}{(1 + \beta V_R)(1 + k_q V_S)} \quad (2.3.12)$$

Choosing $p = 0.05$ and $q = 0.98$ (typical values used for example in the Danish codes) we get $k_{1-p} = 1.645$ and $k_q = 2.054$. For $\beta = 4$ we get $n_{0.05,0.98} = 1, 1.27, 1.59$ for $V_R = V_S = 0, 0.1, 0.15$, respectively. The variation of $n_{0.05,0.98}$ is for this example seen to be about three times less than the variation of n_c . This property that the safety factor $n_{p,q}$ by suitable choice of p and q for a fixed value of β shows considerably less variation with the coefficient of variation for R and S than the central safety factor shows up in an analogous way for the so-called partial safety factors. These are the fundamental elements of the safety method used in several current codes of different countries. The partial safety factor method is the topic of the next section. \square

Exercise 2.1 Assume that R and S are mutually independent and both with lognormal distribution. Then

$$E[\log R] = \log E[R] - \frac{1}{2} \text{Var}[\log R] \quad (2.3.13)$$

$$\text{Var}[\log R] = \log(1 + V_R^2) \quad (2.3.14)$$

and correspondingly for S . (Introduce the notations μ_R and μ_S for $E[R]$ and $E[S]$, respectively). Derive formulas for the failure probability $P(R < S)$ and the central safety factor n_c . Show that n_c is limited for all finite values of V_R and V_S (that is, that the defect of (2.3.11) does not exist here). Derive $n_{p,q}$ under the assumption that $V_R^2 \ll 1$ and $V_S^2 \ll 1$, which allows the use of

$$E[\log R] \approx \log E[R] \quad (2.3.15)$$

$$\text{Var}[\log R] \approx V_R^2 \quad (2.3.16)$$

Investigate the variation of n_c and $n_{0.05,0.98}$ in the same way as in Example 2.5. \square

2.4 Partial safety factors

The requirement of formulation invariance necessitates that the safety method must be applied to the input variables of the mechanical model. Instead of the arbitrary splitting in resistance and corresponding load effect it is necessary to go back to the limit-state equation (2.1.1)

$$g(x_1, \dots, x_n) = 0 \quad (2.4.1)$$

and assign all the safety specifications to the input variables x_1, \dots, x_n of the model. In code connection these input variables should therefore be selected from a standardized class of variables on which the code specifications operate. This does not necessarily mean that these specifications are independent of the model or class of models in which the selected variables participate.

The partial safety factor method is in its mathematical principles a deterministic method that acts in the following way. For the sake of simplicity we will consider the case $n = 2$. Corresponding to each point (x_1, x_2) in the domain of definition of the model the open rectangular neighborhood of (x_1, x_2) defined as the cartesian set product

$$]x_1/\alpha_{m1}, x_1\alpha_{f1}[\times]x_2/\alpha_{m2}, x_2\alpha_{f2}[\tag{2.4.2}$$

is considered. The coefficients $\alpha_{m1}, \alpha_{m2}, \alpha_{f1}, \alpha_{f2}$ are so-called partial safety factors with code specified values that are larger than or equal to 1 (see later though). If this open neighborhood of (x_1, x_2) is a subset of the safe set, then the point (x_1, x_2) per definition represents a structure that according to the code is sufficiently safe.

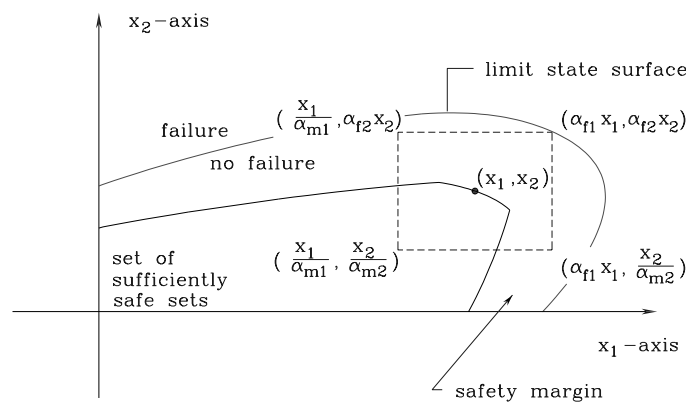

Figure 2.5: The principle of the partial safety factor method by which a codified definition of the set of sufficiently safe states is made for a convex limit-state surface.

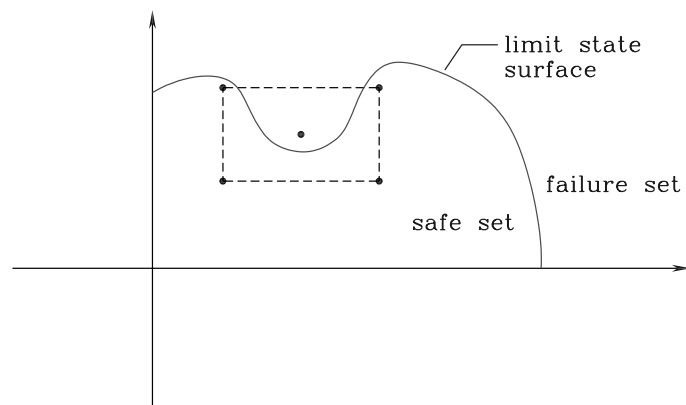

Figure 2.6: Illustration of the inconvenience of the partial safety factor method for non-convex limit-state surfaces.

By inspection of Fig. 2.5 it is seen that the partial safety factor method applied to a convex limit-state problem generates a set of sufficiently safe structures with the property that it is a subset of the

safe set and has a boundary without points in common with the limit-state surface. This property is not necessarily valid for non-convex limit-state problems. Fig. 2.6 illustrates an imagined situation where (x_1, x_2) is a point of the failure set while the four corners of the rectangular neighborhood (2.4.2) are all in the safe set or on the limit-state surface. Thus the partial safety factor method must be applied with particular care and consideration for non-convex limit-state problems. However, these non-convex problems show rarely up in practice in connection with the application of the partial safety factor method.

As described here the partial safety factor model in itself contains no possibilities for choosing the values of the partial safety factors such that this choice in a rational way takes care of the uncertainties that are the reason for having a safety margin. The model is purely deterministic and its value assessments must therefore be based on a calibration to results obtained by the aid of a suitably realistic probabilistic model. The situation is the same as for the safety factor in Section 2.3. After the choice of a suitable failure probability p_f the probabilistic model for a given structural example leads to a choice of the cross-section dimensions, material strengths, and load levels such that the input variables x_1, \dots, x_n modeled as random variables X_1, \dots, X_n have a joint distribution that gives the failure probability

$$P[g(X, \dots, X) < 0] = p_f \quad (2.4.3)$$

The partial safety factor method represents the extreme simplification by representing the random variables X_1, \dots, X_n completely rudimentary replacing each of them by a single or some few characteristic values in the form of suitable fractile values, Fig. 2.4. In Fig. 2.5 the point (x_1, x_2) can be $(E[X_1], E[X_2])$ and the partial safety factors $\alpha_{m1}, \alpha_{m2}, \alpha_{f1}, \alpha_{f2}$ are then analogous to the central safety factor in Section 2.3. In order to get less sensitivity of the partial safety factors with respect to varying standard deviations of the random input variables it is in analogy to the factor $n_{p,q}$ in (2.3.9) preferred to represent each of the random variables by a given upper and a given lower fractile value. The corresponding probabilities may be given in the code and the fractile values are denoted as characteristic values. Let the lower and the upper characteristic values be x_{1c}, \dots, x_{nc} and x_1^c, \dots, x_n^c , respectively. Then the lower characteristic values are divided by the partial safety factors $\gamma_{m1}, \dots, \gamma_{mn}$ while the upper characteristic values are multiplied by the partial safety factors $\gamma_{f1}, \dots, \gamma_{fn}$. The resulting values

$$x_{1c}/\gamma_{m1}, \dots, x_{nc}/\gamma_{mn}, x_1^c\gamma_{f1}, \dots, x_n^c\gamma_{fn} \quad (2.4.4)$$

are denoted as *design values*. This is to be interpreted such that the structure is just sufficiently safe if

$$g(y_1, \dots, y_n) \geq 0 \quad (2.4.5)$$

for all possible choices of y_1, \dots, y_n such that y_i is either the lower design value x_{ic}/γ_{mi} or the upper design value $x_i^c\gamma_{fi}$ and with "=" valid for at least one such choice of y_1, \dots, y_n . The neighborhood shown in Fig. 2.5 is thus modified by use of characteristic values and partial safety factors to the neighborhood of $(E[X_1], E[X_2])$ shown in Fig. 2.7.

After fixing the fractile probabilities for the characteristic values the partial safety factors $\gamma_{m1}, \dots, \gamma_{mn}$ and $\gamma_{f1}, \dots, \gamma_{fn}$ are ideally chosen such that the structure in the probabilistic model

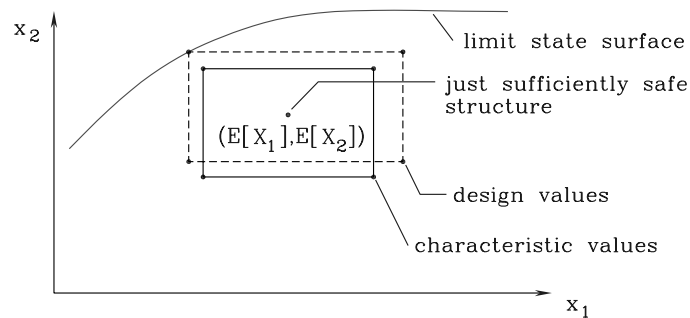

Figure 2.7: Application of the partial safety factors on characteristic values to obtain the design values.

has the prescribed failure probability p_f . For the given structure type there are in general several different choices of dimensions or material strength levels that in the probabilistic model give the same failure probability. After each such choice (of which some are more convenient and economical than others) the characteristic values are uniquely fixed. However, there is still a certain freedom to choose the values of the partial safety factors in an infinity of ways such that the requirement (2.4.5) is satisfied. Therefore it is possible to calibrate the partial safety factor values such that more structures for the same partial safety factor values have the given failure probability p_f .

The next section gives a first analysis of how, on the basis of a reasonably rational probabilistic model, a code committee should choose the partial safety factors such that the resulting code gives results that within suitable well-defined classes of structures are best adapted to the results of the probabilistic model. A more detailed treatment with examples will be given in Appendix 1 on code calibration.

Historically the first applications of the partial safety factors in the codes were only supported on consequence calculations (see Chapter 1) and qualitative probability considerations. The coefficients were applied to central or prudently assessed values for material strengths and loads. A guiding principle was that the size of the partial safety factors value should reflect the degree of uncertainty or random variability of that strength or load parameter to which the partial safety factor was applied. However, this principle is not applicable when the partial safety factors are defined to be applied on lower and upper characteristic values. Of course, the uncertainties of the corresponding parameters are then already taken into account to some extent. The partial safety factors therefore rather have the purpose of taking other sources of uncertainty into account as for example those that concern the interaction of the uncertainties and those that concern the model uncertainties. Therefore there is no reason for not having a partial safety factor value less than 1 (exemplified in Fig. 2.7).

In principle the partial safety factor method given by (2.4.4) and (2.4.5) requires a check of (2.4.5) at 2^n points. For increasing n this becomes so large a number of points that it might be doubtful if there is a saving of effort by the partial safety factor method instead of directly codifying the probabilistic model. The point is, however, that the function g for most of the usual structural problems has a strongly simplifying monotonicity property. From a point in the safe set, g will most often decrease with increasing values of some of the variables x_1, \dots, x_n and decreasing values

of the rest of the variables. The variables of first category have the character of load variables, that is, such variables that by increase bring the structure closer to failure. The variables of the other category have the character of resistance variables, that is, such variables that by decrease bring the structure closer to failure. It is obvious that the safety check with respect to a limit state that can be defined in terms of such a function g only requires a check of the inequality (2.4.5) at a single point

$$(y_1, \dots, y_n) = (x_{1c}/\gamma_{m1}, \dots, x_{rc}/\gamma_{mr}, x_{r+1}^c/\gamma_{fr+1}, \dots, x_n^c/\gamma_{fn}) \quad (2.4.6)$$

Here we have assumed that the r first variables are of resistance type and the $n - r$ last of load type. The check point (2.4.6) is sufficient for most of the practical problems where the partial safety factor method is applied.

2.5 Allowable degree of arbitrariness of the choice of partial safety factor values*

Assume for simplicity that the limit state has a form that only requires a single check point (2.4.6). To simplify the notation we will write the point $(x_{1c}, \dots, x_{rc}, x_{r+1}^c, \dots, x_n^c)$ of characteristic values as (x_1, \dots, x_n) while we will write $(1/\gamma_{m1}, \dots, 1/\gamma_{mr}, \gamma_{fr+1}, \dots, \gamma_{fn})$ as $(\theta_1, \dots, \theta_n)$. The condition (2.4.5) is then just satisfied if

$$g(x_1\theta_1, \dots, x_n\theta_n) = 0 \quad (2.5.1)$$

For given values of the coefficients $(\theta_1, \dots, \theta_n)$ and for given values of (x_1, \dots, x_{n-1}) , for example, the value of x_n can be determined by this equation. This corresponds to the typical design situation where the engineer takes the values $(\theta_1, \dots, \theta_n)$ from the code, chooses (x_1, \dots, x_{n-1}) and finally calculates x_n (that for example might be the web area of a steel beam or the reinforcement area of a concrete cross-section). Several different considerations of qualitative nature may have lead to the choice of (x_1, \dots, x_{n-1}) (architectural reasons, manufacturing reasons, traditions etc.)

The code committee is facing another problem. The values of (x_1, \dots, x_n) are given for example as the result of a calculation within a probabilistic model and on the basis of a given failure probability. This failure probability might be chosen by comparative consequence calculations, see Chapter 1. The structure defined by the values (x_1, \dots, x_n) may also be chosen by the code committee among the existing structures as a structural example that according to the judgment of the code committee represents good (optimal) and safe engineering practice. The equation (2.5.1) can then be considered as an equation with the coefficients $\theta_1, \dots, \theta_n$ as unknown. Any choice of $\theta_1, \dots, \theta_n$ that satisfies (2.5.1) will then give a value set of the partial safety factors such that x_1, \dots, x_n define a just sufficiently safe structure.

For a more detailed discussion of this problem of choice it is useful first to make a dimension analysis of the equation (2.5.1). Since the equation concerns a physical phenomenon the equation must necessarily be dimension homogeneous. We will only consider the most often appearing case where all the physical quantities x_1, \dots, x_n have units that are power products of the basic units of force and length. The dimension analysis then shows that it is possible to define exactly $n - 2$

independent dimensionless power products p_1, \dots, p_{n-2} of the quantities x_1, \dots, x_n . It is next a consequence of the so-called π -theorem on dimension homogeneous expressions that the equation (2.5.1) can be rewritten as an equation

$$G(p_1 v_1, \dots, p_{n-2} v_{n-2}) = 0 \quad (2.5.2)$$

between the dimensionless power products such that v_i is exactly the same power product of $(\theta_1, \dots, \theta_n)$ as p_i of x_1, \dots, x_n and where the function G is a function of $n - 2$ variables.

It follows from this that for $n > 2$ two of the coefficients $(\theta_1, \dots, \theta_n)$ can be chosen freely between the positive numbers without in any way introducing restrictions that influence the set of just sufficiently safe structures. If, for example, some arbitrary values are assigned to θ_1 and θ_2 , and v_1, \dots, v_{n-2} are chosen such that (2.5.2) is satisfied, then values are assigned to the remaining $n - 2$ coefficients $(\theta_3, \dots, \theta_n)$ by this choice.

In practice the case $n = 2$ will often show up. It is then only possible to choose one of the partial safety factors freely. In the present Danish codes it has been chosen to let the factor on the permanent load (weight of structural parts, of soil and of ground water) have the value 1. In the present version of the European code some of these load types are assigned a partial safety factor larger than 1.

Remark 2.1 It has occasionally been erroneously claimed that this freedom of the code committee to make any choice of the value of the partial safety factor on the permanent load is only valid under the condition that the function g is linear, that is, under the condition that the limit state surface is a hyperplane through the origin. On the other hand, it has also been claimed that another value than 1 for the partial safety factor on the weight of soil and ground water will lead to inconsistency in geotechnical calculations. Also this claim is not right noting that the same input variable everywhere in the model is subject to the same partial safety factor either everywhere by multiplication or everywhere by division. The error of conception seems to appear due to a more or less arbitrary splitting of the function g into a resistance and a load effect with the same input variable appearing in both expressions and in such a way that an increase of the value of the variable is favorable for the safety in the one expression and unfavorable for the safety in the other expression. \square

Remark 2.2 It can be necessary not to fix a partial safety factor to a given value valid universally for the entire domain of the code. Such a fixing of a value may imply an inconvenient large variation of other partial safety factors. In the Danish codes, for example, there are two exceptions from the previously mentioned fixed value 1. The one exception concerns "cases where the permanent action from structural members is in favor of, and has vital significance to the safety of the structure, e.g. lifting and overturning of a structure". The other exception concerns "cases where the permanent action is large compared to the variable action". \square

For each structure with corresponding limit states considered as just sufficiently safe by the code committee, an equation as (2.5.2) can be formulated. By the choice of a suitable number of independent equations ($n - 2$ if they are all linear) there will be a possibility for a unique determination of v_1, \dots, v_{n-2} when all these equations are required to be satisfied. If the values of the coefficients $\theta_1, \dots, \theta_n$ obtained in this way are used to define the values of the partial safety factors in the code, the equation (2.5.1) becomes for any other structure with corresponding function g a

design equation for the determination of x_1, \dots, x_n . Any such equation can then be interpreted as yielding an interpolation between those structures that by the code committee are chosen as being just sufficiently safe. Hereby the code committee claims that all structures defined in this way within a given class of structural types are just sufficiently safe in the sense of the code. However, there will be inconsistency with a prescribed failure probability assigned to the probabilistic model even though the particularly chosen structures all have the given failure probability. If the deviations are small within the specified class of structural types, as judged by the code committee, the code may be declared to satisfy the requirement of a specified reliability level with sufficient accuracy.

This principle where the partial safety factors, when applied to some few chosen structural examples, correspond exactly to the chosen failure probability is not necessarily the most reasonable principle for calibration of the partial safety factor code to the results following from a probabilistic code. This calibration problem is reconsidered in Appendix 1.

2.6 Action models

Those action models that usually are applied together with the partial safety factor method have a very idealized nature. Essentially they consist of point actions (single forces) and of surface actions (blocks of load intensities) the latter usually being of a piecewise linear shape. Occasionally the variation of the action in space and time is derived deterministically from the geometric and mechanical model of the structure or from a more extended model that contains smaller or larger parts of the environment from which the actions are generated.

A load code like the Danish code DS 410 gives a detailed list of many different types of actions that can be relevant in codified design. For each action type a characteristic value is specified, for example the 98%-fractile for the yearly maximal load value or just a prescribed value. Moreover, values of so-called reduction factors are specified. The reduction factors are defined as factors to be applied on characteristic values to get different types of usual values. DS 410 contains only one type of usual actions. The current European code contains several types of usual actions. With respect to the surface actions, an action code usually also gives information about the nature of the spatial variations and about how large a part of the action that must be considered as a free action while the rest is considered as a fixed action. Specifying an action to be free in the sense of DS 410 is the same as requiring that the action must be considered in the safety checking with values chosen independently from point to point and with any value between zero and a specified maximal value being possible. A fixed action is assumed to be known all over the structure if it is known at any single point.

The concept of free action can be illustrated by the following example. Consider a prismatic beam that spans continuously over four equal bays, see Fig. 2.8. The bending moments of the beam are supposed to be determinable by the linear elastic beam theory. The beam is subject to free load with maximal intensity p . Referring to the definition of free action the decisive load intensity distribution with respect to the safety against failure of a given cross-section can then be the intensity distribution that in the given cross-section gives the maximal bending moment.

Consider the load intensity distributions shown in Fig. 2.8. In each of the loaded bays there is

a cross-section in which the bending moment takes a local maximal value. Moreover, the bending moment takes a local minimal value (negative) above the internal supports. All these bending moments must therefore be calculated in order to determine the largest bending moments in absolute value. Fig. 2.8 shows 4 of the 15 load intensity distributions that make up all combination possibilities with a constant free load of maximal or minimal value over each of the bays. There are an infinity of other distributions of the free load that according to the codes should be investigated. An elasticity theoretical consideration shows, however, that all these other cases with load intensity at each point between 0 and p will not give larger maximal moments than those obtained from the mentioned 15 intensity distributions. The fixed load that for example might correspond to the self-weight of the beam is described by the load intensity variation shown as the first in Fig. 2.8.

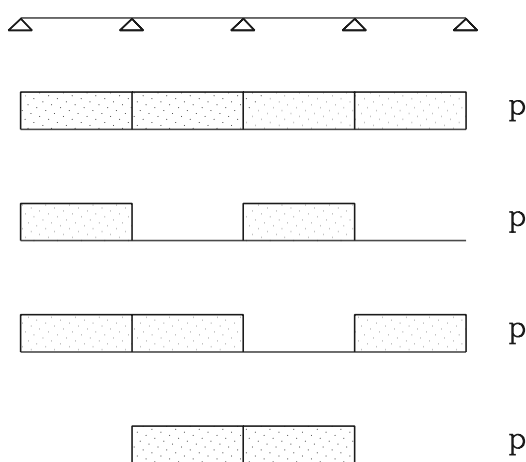

Figure 2.8: Illustration of the concept of “free load” as given in DS 410. Continuous beam over several bays.

For more complicated structures the definition of free action in the sense of the code can imply that in principle it is necessary to do check calculations for a very large number of load combination blocks and point load combinations on the structure. Considering this, it is worth noting that the corresponding investigations within a probabilistic model for free load not only corresponds to a more realistic description of the nature of the random load variation across the structure, but can also imply a considerably less extensive calculation effort. This is because the deterministic model requires the solution of a difficult problem of extremum search, looking for the absolute largest action effect that can occur within the model. In contrast to this the problem within a probabilistic model is to determine a probability distribution of the action effect when the free action within the model is described by a probability distribution. This problem does not require an investigation for each of a long series of different specific load formations. Instead only an integration is required over all the load possibilities as weighted by the probabilities of the model. In its analytical form the calculation is of a completely different type than the corresponding calculation in the deterministic model. Often though, the problem in the probabilistic model can only be solved by so-called Monte Carlo simulation because analytical solution methods very easily become mathematically too complicated. By the Monte Carlo simulation method a suitably large sample of typical load configurations is simulated from the probabilistic action model. This load configuration sample

gives a corresponding sample of load effects at different points of the structure and from this sample the probability distributions of the load effects can be estimated. By use of these probability distributions, extreme value studies can next be made. In this sense the probabilistic model uses typical load configurations in its solution procedure and not difficult choices of "extreme" load configurations as they are used in the deterministic model.

Except for models of a very simple structure the treatment of probabilistic load models for spatial variation is outside the scope of this first part of the theory of structural reliability. This first part rests on descriptions that can be made solely by use of random vectors.

2.7 Load combinations*

Load combination deals with several simultaneously acting loads on the structure. It is the combined effect of these loads that is of interest when studying the structural reliability.

A typical example is a multi-story building supported on columns in which snow load on the roof, wind load on roof and facades and floor loads from the individual stories all contribute to the internal forces of the columns. The point is that in general it will be too much to the safe side to choose the dimensions of the columns on the basis that all considered loads are represented by their characteristic values corresponding to the distributions of the yearly maxima. Simultaneous occurrence of such extreme values can be considered to be an improbable event and the more so the more contributing relevant loads. The use of unreduced characteristic values imply that the reliability with respect to a column failure computed within the probabilistic model increases with the number of stories that the column is designed to carry. It should be noted, however, that this property is tied to the assumption that the model does not prescribe complete dependency between the loads on the different stories.

In the following example we will consider a very simple probabilistic model for the column forces coming from the floor loads. It is emphasized that the assumptions of the model are not based on statistical investigations of real floor loads and that it is unrealistic in this respect. Its mathematical form is solely chosen in order to obtain simple algebra and results.

Example 2.6 Suppose that a column carries load from n stories and that each floor load is renewed after each time unit. Thus from each story there is a column force X_{ij} , where $i = 1, \dots, n$ is the story number while j is the number of the time interval, $j = 1, 2, \dots, N$. In the j th time interval the column force is

$$Y_j = X_{1j} + \dots + X_{nj} \quad (2.7.1)$$

and the maximal column force after N time intervals is

$$Z = \max\{Y_1, \dots, Y_N\} \quad (2.7.2)$$

Assume that X_{ij} all are mutually independent with the distribution function $F_1(x)$, and let $\bar{F}_1(x) = 1 - F_1(x)$ be the complementary distribution function. Moreover, assume that the characteristic value x_c is given for $\max\{X_{i1}, \dots, X_{iN}\}$ as the $(1 - \epsilon)$ -fractile. The assumptions imply that the

characteristic value is the same for all $i = 1, \dots, n$. Thus we have

$$[1 - \bar{F}_1(x_c)]^N = 1 - \epsilon \quad (2.7.3)$$

or, since $\bar{F}_1(x_c) \ll 1$,

$$1 - N\bar{F}_1(x_c) \approx 1 - \epsilon \quad (2.7.4)$$

From this it follows that

$$N \approx \frac{\epsilon}{\bar{F}_1(x_c)} \quad (2.7.5)$$

The characteristic value of Z is denoted z_c and it is given by

$$[1 - \bar{F}_n(z_c)]^N = 1 - \epsilon \quad (2.7.6)$$

or, as before,

$$N \approx \frac{\epsilon}{\bar{F}_n(z_c)} \quad (2.7.7)$$

Here \bar{F}_n is the complementary distribution function of $X_{1j} + \dots + X_{nj}$ and \bar{F}_n is independent of j . From (2.7.5) and (2.7.7) it follows that

$$\bar{F}_n(z_c) \approx \bar{F}_1(x_c) \quad (2.7.8)$$

For n large it can be assumed with reference to the central limit theorem that \bar{F}_n can be approximated by the normal complementary distribution function

$$\bar{F}_n(z_c) = \Phi\left(\frac{n\mu - z_c}{\sqrt{n}\sigma}\right) \quad (2.7.9)$$

in which $\mu = E[X_{ij}]$, $\sigma^2 = \text{Var}[X_{ij}]$. It is used here that Y_j in (2.7.1) has the mean value $n\mu$ and the variance $n\sigma^2$. The last property follows because the terms in (2.7.1) are mutually independent. By substitution into (2.7.8) we then get that

$$z_c = n\mu + \sqrt{n}\sigma\Phi^{-1}[F_1(x_c)] \quad (2.7.10)$$

since $\Phi^{-1}[\bar{F}_1(x_c)] = -\Phi^{-1}[F_1(x_c)]$.

In the Danish Standard DS 409 (the safety code) it is stated that the design value of the total load Z can be determined as $\gamma x_c + (n-1)\psi_n x_c$, where γ is a given partial safety factor for load and where ψ_n is a reduction factor that reduces x_c to a "usual value" $\psi_n x_c$. If it is agreed that the design value of the total load is γz_c , that is, the same partial safety factor is applied to z_c as to x_c , we have that

$$z_c = x_c + (n-1)\psi_n x_c / \gamma \quad (2.7.11)$$

which for large n should be consistent with (2.7.10). From this it follows that ψ_n/γ for large n becomes

$$\frac{\psi_n}{\gamma} = \frac{\mu}{x_c} + \frac{\mu - x_c + \sqrt{n}\sigma\Phi^{-1}[F_1(x_c)]}{x_c(n-1)} \quad (2.7.12)$$

showing that

$$\psi_\infty = \frac{\mu}{x_c}\gamma \quad (2.7.13)$$

Thus the specification of constant values for ψ_n in the Danish standard DS 410 (the load code) is only asymptotically consistent with (2.7.12).

As an example assume that X_{ij} is normally distributed with parameters (μ, σ) , where the coefficient of variation $V = \sigma/\mu$ is sufficiently small ($V < 0.3$) that the probability of getting negative load contributions is vanishing small compared to the probability of getting positive load contributions. Then

$$\Phi^{-1}[F_1(x_c)] = \frac{x_c - \mu}{\sigma} \quad (2.7.14)$$

which upon substitution in (2.7.12) and division by (2.7.13) gives

$$\frac{\psi_n}{\psi_\infty} = 1 + \frac{\gamma - \psi_\infty}{\psi_\infty} \frac{1}{1 + \sqrt{n}} \quad (2.7.15)$$

for $n \geq 2$. (In this special case with normal distribution the formula (2.7.12) is valid for all $n \geq 2$).

Example values are $\psi_\infty = 0.65$ and $\gamma = 1.3$ giving $x_c/\mu = 2.0$. From (2.7.5) it is then seen that the corresponding number of load renewals N becomes

$$N \approx \frac{\epsilon}{\Phi\left(-\frac{\mu}{\sigma}\right)} = \frac{0.02}{\Phi\left(-\frac{1}{V}\right)} \quad (2.7.16)$$

when it is assumed as in DS 409 that the characteristic value is the 98%-fractile. For $V = 0.3$ the formula (2.7.16) gives $N \approx 47$, which by and large corresponds to one load renewal per week if x_c is assumed to be the characteristic value of the yearly maximal value of the load contribution from the individual story. The corresponding reduction factor ratio ψ_n/ψ_∞ can be read from Table 2.1 as a function of the number of stories n .

n	2	4	8	16	∞
ψ_n/ψ_∞	1.414	1.333	1.261	1.200	1.000

Table 2.1: Load reduction factor ratio ψ_n/ψ_∞ as a function of the number of stories n for the case $\mu/x_c = 0.5$ ($= \psi_\infty/\gamma$) and normally distributed load pulses with parameters (μ, σ) (about 47 load renewals per year).

The model considered here is an excessive simplification of the real load phenomena. For example, a realistic load model for frequently renewing loads must assign a considerable positive

probability to the event that $X_{ij} = 0$. This corresponds to the event that the considered load type not at all is present on the i th story in the j th time unit. Under such conditions the normal distribution is unfit as a realistic model for the load pulse distribution. A more realistic model is considered in Example 10.2.

The deterministic load combination problem concerning load coincidences in time as considered in this section has the same difficulty as the load combination problem concerning the spatial variation over the structure of the free load mentioned in the previous section, namely that the number of combination possibilities may become excessively large. Therefore it is not excluded that computations within a probabilistic model for load combinations in the time domain also can be simpler to carry out in specific reliability analysis problems than the deterministic combination checking. To this adds the advantage of the larger degree of rationality and realism in the model formulation.

No further details will be given here about the load combinations that are required to be checked in the safety code DS 409. On the basis of the information given in this chapter the rules in DS 409 and DS 410 should be directly interpretable without problems. \square

2.8 Historical and bibliographical notes

The safety factor principle, naturally, is as old in engineering practice as the use of calculation models to guide the design of structures. According to A.J. Moe [2.4] there were discussions as long back as in the middle of the 19th century concerning the practical handling of the safety question by use of certain types of partial safety factors. A consistent code formulation of a detailed partial safety factor principle was started in the 1950s in Denmark before other places in the world. This development got particular support from the considerations of J. Brinch Hansen [2.1] who applied the principles in the field of soil mechanics.

Bibliography

- [2.1] J. Brinch Hansen (1959) Definition und Grösse der Sicherheitsgrades im Erd- und Grundbau. *Der Bauingenieur*, 87-89.
- [2.2] Dansk Ingeniørforening's Code of Practice for the Safety of Structures (1983) Translation of Dansk Standard DS 409, 1. edition. NP-157-T. Teknisk Forlag, Copenhagen.
- [2.3] Dansk Ingeniørforening's Code of Practice for Loads for Design of Structures (1983) Translation of Dansk Standard DS 410, 3. edition. NP-157-T. Teknisk Forlag, Copenhagen.
- [2.4] A.J. Moe (1968) *Om sikkerhedsgraden i faststående statiske konstruktioner*. Teknisk Forlag, Copenhagen.
- [2.5] Nordic Committee on Building Regulations: Recommendation for Loading- and Safety Regulations for Structural Design (1978) NKB-Report No. 36.

This page is intentionally left blank.

Chapter 3

PROBABILISTIC INFORMATION

3.1 Randomness and uncertainty

Let us look at a material property on the basis of measurements on a number of test pieces assumed to have representative properties. Generally it should be expected that uncontrollable fluctuations of many different factors during the manufacturing of the considered material lot will show up as random variations of the material property from test piece to test piece. These variations can be called physical fluctuations. Hereby it is indicated that the variations are of a type that cannot be eliminated from the object by extensive measurements on the object. We imagine that these physical fluctuations are inherent to the object, in the present example the sample of test pieces.

Usually we anticipate that the measuring results obtained directly from the measuring device of the test equipment are somewhat different from the numbers representing the inherent properties. This anticipation is based on the experience that two different test equipments applied to a material with the same inherent random property variation can show significant differences between the two samples of test results.

The conclusion is that the variation of the obtained results expresses the sum of the physical fluctuations inherent to the object of observation and the fluctuations inherent to the method of observation. These last mentioned fluctuations contribute to a type of uncertainty called measuring uncertainty. Besides contributing with zero mean random fluctuations it can contribute with systematic errors that cannot be eliminated by averaging.

In principle it is not possible to remove the fluctuations generated by the measuring method directly from the obtained values in order to obtain the inherent physical values. However, the methods of probability theory make it sometimes possible to formulate statements about the statistical nature of the physical fluctuations. This is the case if the measuring method can be applied several times to an object for which the relevant physical property is known to be constant or only slightly varying from measurement to measurement. By such a series of repeated measurements, information about the uncertainty of the measuring method is generated in a form that through statistical methods can be represented by a probabilistic model. When the measuring method thereafter is applied to an object with inherent physical fluctuations, the measuring uncertainty can be eliminated within a probabilistic description of the nature of the physical fluctuations. However, the dependency between the error Y and the physical quantity X must not be too complicated.

Example 3.1 Assume that a physical quantity fluctuates randomly. It is then natural to model the quantity by a random variable X . Assume that the quantity is measured by a method where the measuring uncertainty can be represented by a random variable Y which is independent of X . The measured results are then represented by the sum

$$Z = X + Y \quad (3.1.1)$$

Statistical analysis of the measured data gives estimates of the mean value $E[Z]$ and the variance $\text{Var}[Z]$. The uncertainty properties of the measuring method are known in advance and are reported by $E[Y]$ and $\text{Var}[Y]$. It follows then from (3.1.1) that $E[X] = E[Z] - E[Y]$ and from the independence between X and Y that

$$\text{Var}[X] = \text{Var}[Z] - \text{Var}[Y] \quad (3.1.2)$$

If this formula gives a negative value, the reason is that the assumption of independence between X and Y is not valid. Without this assumption the formula (3.1.2) should be replaced by, see Remark 4.1,

$$\text{Var}[X] = \text{Var}[Z] - \text{Var}[Y] - 2\text{Cov}[X, Y] \quad (3.1.3)$$

where the right hand side always will be non-negative. However, the formula (3.1.3) is not directly applicable in this connection. Neither $\text{Var}[Y]$ nor $\text{Cov}[X, Y]$ are known because the measuring method in this situation is dependent of the object for measurement. We return to this problem in an example in Chapter 4.

If it is assumed that the measuring uncertainty probabilistically can be described by the normal distribution and that the statistical analysis of the measured data shows that it is reasonable also to describe these data by a normal distribution, then it is not in conflict with the given information to assume that $X = Z - Y$ is normally distributed. However, this assumption is not a consequence of the assumption that both Z and Y are normally distributed. More is required for such a conclusion, namely that the pair (Z, Y) has a two-dimensional normal distribution. Of course, such an assumption cannot be verified by measurement and therefore it will not be possible to verify an assumption that states that X is not normally distributed. \square

Example 3.1 illustrates in which sense it is possible to "clean" the measuring results for measuring uncertainty when the measuring method is well examined. However, as to principle we face a difficulty. When the relevant material property is of type like a strength it is difficult if not impossible to perform the necessary repeated measurements on the same test piece. The evaluation of the measuring uncertainty therefore must be based on indirect investigations about the way of functioning of the test equipment combined with experiences from comparisons of different measuring methods.

It is hardly possible to make a complete elimination of the measuring uncertainty when dealing with material strengths or other material properties that during the measuring procedure are changed irreversibly. Therefore it is an important condition for joining such measuring results into a common sample of comparable values that they are obtained from the same measuring method. In order that results from different measuring methods can be made comparable the aforementioned comparisons of measuring methods should lead to a transformation rule (a mapping) from

the one measuring method to the other. This rule should ideally satisfy the minimum requirement to be defined such that when it is applied to the set of data from the one measuring method then a transformed set of data is obtained which in a specified statistical sense can be assumed to be comparable with the set of data from the other measuring method. However, it is not necessarily required that a transformed data value from the first measuring method must be almost the same as the value that would have been obtained by the second measuring method, even though a requirement like this is often set up for measuring methods of small uncertainty. For measurements of irreversible material properties the compliance with such a requirement cannot be controlled by measurement, of course. Thus a transformation rule between data coming from different measuring methods should be considered as a general type of a correction rule for removing the systematic error of the one measuring method relative to the other measuring method.

In general there will be a considerable uncertainty about the truth of a statement that specifies the value of a systematic error. If this uncertainty can be subject to a quantitative evaluation, e.g. of character as a bet, then it can also be represented by a probabilistic model that from a mathematical point of view does not deviate in its principle from a probabilistic model for the ensemble of physical fluctuations. The uncertainty is of a different nature, however. Contrary to the physical fluctuations the uncertainty is affected by closer investigations. This fact has motivated a separation between randomness and uncertainty. The inherent randomness related to the object cannot be reduced by observation while the uncertainty can. The words "measuring uncertainty" seem to cover a mixture of the two concepts. A given measuring method may possess a systematic error which is only known with some uncertainty, but by more detailed investigations of the measuring method this uncertainty can be reduced or practically removed. Besides a systematic error, a measuring method usually shows random fluctuations which normally also is covered by the words "measuring uncertainty" even though the words "measuring randomness" possibly would be better. On the other hand, the measuring randomness can be affected by changing the measuring method.

We see that the classification of the discussed concept of indeterminacy into randomness and uncertainty is relative to the object. If the object of study is the measuring method itself, then the physical fluctuations inherent to the object is characterized as randomness. If the object for measuring is the object of study, then we speak about measuring uncertainty.

For the appreciation of the possibilities of affecting the reliability of a structure by engineering arrangements, this splitting into randomness and uncertainty is of obvious importance. A reliability problem contains several indeterminacies of uncertainty type that can be reduced by extended efforts of collecting information without any change of the structural solution itself (the structural layout). The indeterminacies of randomness type can only be affected by structural arrangements, however.

Measuring uncertainty has in this section been discussed as an uncertainty adjoined to the result of a single measurement. By this it gets the same character as the concept of model uncertainty which will be a topic of discussion later in the chapter. Measuring uncertainty of a completely different kind is called statistical uncertainty.

3.2 Statistical uncertainty

It is the purpose of any measuring method to generate information about a quantity related to the object of measurement. If the quantity is of a fluctuating nature so that it requires a probabilistic model for its description, the measuring method must make it possible to formulate quantitative information about the parameters of the chosen probabilistic model. It is obvious that a measured value of a single outcome of a non-degenerate random variable X only is sufficient for giving a crude estimate of the mean value of X and is insufficient for giving any information about the standard deviation of X . However, if a sample of X is given, that is, if measured values of a certain number of independently generated outcomes of X are given, these values can be used for calculating estimates for all parameters of the model. The reasons that such an estimation from a sample of X is possible and makes sense are to be found in the mathematical probability theory. The most elementary concepts and rules of the theory of statistics are assumed to be known to the reader.

To illustrate the role of the statistical concepts in the reliability analysis it is worthwhile to repeat the most basic features of the description of the information that a sample of X of size n contains about the mean value $E[X]$. It is sufficient for our purpose to make the simplifying assumption that X has a known standard deviation $D[X] = \sigma$. Besides this the only available information is given as the sample x_1, \dots, x_n of X . Then it is obvious that an estimate of the mean value $\mu = E[X]$ must be calculated as the value of some function $\hat{\mu}(x_1, \dots, x_n; \sigma)$. Remembering that the values x_1, \dots, x_n are obtained by repeated mutually independent experiments giving outcomes of X , or more precisely, as a single outcome of the random vector (X_1, \dots, X_n) , where X_1, \dots, X_n are mutually independent random variables all distributed as X , it is natural to study the distributional properties of the random variable $\hat{\mu}(X_1, \dots, X_n; \sigma)$. For example, it seems to be appropriate to choose the function $\hat{\mu}$ (the estimator) so that

$$E[\hat{\mu}(X_1, \dots, X_n; \sigma)] = \mu \quad (3.2.1)$$

and so that the variance $\text{Var}[\hat{\mu}(X_1, \dots, X_n; \sigma)]$ becomes as small as possible. This exercise requires distributional assumptions about X and the determination is in most cases a difficult problem in variational calculus. If we are content with the class of linear estimators, then no distributional assumptions are needed and it turns out that the best choice is the average

$$\hat{\mu} = \frac{1}{n} \sum_{i=1}^n X_i \quad (3.2.2)$$

for which the standard deviation is

$$D[\hat{\mu}] = \frac{\sigma}{\sqrt{n}} \quad (3.2.3)$$

We see that the average $\bar{x} = (x_1 + \dots + x_n)/n$ of the sample is an estimate of μ , but also that the estimate is uncertain. The standard deviation (3.2.3) can with the appropriate interpretation be taken as a measure of this uncertainty. In particular it is seen that the uncertainty vanishes asymptotically as $n \rightarrow \infty$. In the present formulation it decreases inversely proportional to the square root of the sample size.

Uncertainty of this kind is called statistical uncertainty and, as seen, it concerns incomplete information due to the finite sample size. It can be interpreted as a fluctuation even though it is usually not observed as such in practice. Only a single value of the average \bar{x} is obtained from the sample. However, one can imagine a sequence of repeated outcomes of $\hat{\mu}$ by taking new samples of size n . Then $\hat{\mu}$ fluctuates exactly as a quantity with indeterminacy of random type from a distribution with standard deviation defined by (3.2.3).

The quantitative description of statistical uncertainty considered here is not appropriate as input for a probabilistic model concerning evaluation of structural reliability. This is because such a model requires that contributions from different sources of randomness and uncertainty can be joined together in an integrated model following logically consistent rules. Assume that the aforementioned random variable X is contained in a probabilistic structural model. Since the mean value $E[X]$ is unknown, it is necessary in order to calculate the failure probability to assume that $E[X]$ has a given value μ . Thus the failure probability becomes a function $p_f(\mu)$ of μ . Then there is a problem of how μ should be chosen. One possibility is, of course, to be content with the value $p_f(\hat{\mu})$ or with a suitable confidence interval for $p_f(\mu)$ determined by use of (3.2.2) and (3.2.3). (Within the aforementioned model for statistical uncertainty a p % confidence interval of a parameter as μ or as $p_f(\mu)$ is an interval which has a probability of p % of covering the "true" value of μ or $p_f(\mu)$. This probability can be interpreted as a relative frequency related to the aforementioned imaginary sequence of samples).

It is reasonable to ask for a unique definition of the total unconditional failure probability p_f . Such a probability is needed in a decision model that is based on the principle of maximizing some measure of utility (Chapter 12). A natural definition is a weighted average of the different values of $p_f(\mu)$, that is,

$$p_f = \int_{\text{all } \mu} p_f(\mu) f(\mu) d\mu \quad (3.2.4)$$

in which $f(\mu) \geq 0$ is a suitable weighting function satisfying

$$\int_{\text{all } \mu} f(\mu) d\mu = 1 \quad (3.2.5)$$

It is seen that $f(\mu)$ possesses properties as a density function for a random variable. If μ is interpreted as an outcome of a random variable M , then $p_f(\mu)$ is the conditional failure probability given that $M = \mu$. According to the addition theorem of the probability theory the total failure probability becomes

$$p_f = \int_{\text{all } \mu} p_f(\mu) f_M(\mu) d\mu \quad (3.2.6)$$

in which $f_M(\mu)$ is the density function of M . Thus the weighting function $f(\mu)$ can be interpreted as a density function $f_M(\mu)$ for the parameter μ modeled as a random variable M . As for (3.2.2) and (3.2.3) the distribution properties of M must be generated in some way from the information contained in the sample x_1, \dots, x_n of outcomes of X and the knowledge of the standard deviation $D[X] = \sigma$.

The usual way of looking at this problem is that of Bayesian statistical theory: Before the sample information is available a density $f_M(\mu)$ (the prior) is adjoined to M . This prior density is

assumed to represent the available knowledge about μ before the sample x_1, \dots, x_n is known. Since the random vector (X_1, \dots, X_n) according to the multiplication theorem for independent events has the conditional density

$$f_{X_1, \dots, X_n}(x_1, \dots, x_n | \mu) = \prod_{i=1}^n f_X(x_i | \mu) \quad (3.2.7)$$

the total density becomes

$$f_{M, X_1, \dots, X_n}(\mu, x_1, \dots, x_n) = f_M(\mu) \prod_{i=1}^n f_X(x_i | \mu) \quad (3.2.8)$$

and thus the conditional density

$$f_M(\mu | x_1, \dots, x_n) \propto f_M(\mu) \prod_{i=1}^n f_X(x_i | \mu) \quad (3.2.9)$$

where " \propto " means proportional to (that is, the two sides are equal, except for a normalizing constant determined by (3.2.5)). This is the so-called posterior density for M given the sample x_1, \dots, x_n . If the right hand side of (3.2.9) is proportional to a density, even if $f_M(\mu)$ is put to 1, or if $f_M(\mu)$ is put to a function of μ which is slowly varying as compared to the variation of

$$\prod_{i=1}^n f_X(x_i | \mu) \quad (3.2.10)$$

then such a slowly varying function of μ can replace the prior density and serve as a model for having no prior information. The product (3.2.10) considered as a function of the parameter μ is called the likelihood function. This formulation of a model for the description of the statistical uncertainty and its reduction by updating on the basis of the sample information is called Bayesian after Thomas Bayes (1702-61). The formula (3.2.9) is at special case of the so-called Bayes' formula.

If we adopt the Bayesian statistical method as a rational way to model available information, then as a consequence we should use the most updated posterior density of M as the function f in the formula (3.2.4).

Example 3.2 Assume that X is normally distributed with the density function

$$f_X(x | \mu) = \frac{1}{\sigma} \varphi\left(\frac{x - \mu}{\sigma}\right), \quad x \in \mathbb{R} \quad (3.2.11)$$

The likelihood function becomes

$$\begin{aligned} \prod_{i=1}^n f_X(x_i | \mu) &\propto \prod_{i=1}^n \exp\left[-\frac{1}{2}\left(\frac{x_i - \mu}{\sigma}\right)^2\right] \\ &\propto \exp\left[-\frac{1}{2\sigma^2} \sum_{i=1}^n (x_i^2 - 2\mu x_i + \mu^2)\right] \\ &\propto \exp\left[-\frac{n}{2\sigma^2} (\mu^2 - 2\mu \bar{x} + \bar{x}^2)\right] \\ &\propto \varphi\left(\frac{\mu - \bar{x}}{\sigma/\sqrt{n}}\right) \end{aligned} \quad (3.2.12)$$

where \bar{x} is the average of x_1, \dots, x_n (compare with (3.2.17)). Thus the likelihood function is proportional to the normal distribution density with mean value \bar{x} and standard deviation σ/\sqrt{n} . Therefore the right hand side of (3.2.9) is a density when $f_M(\mu)$ is replaced by 1. Formally setting the prior density to a constant is expressed by saying that we have chosen a prior density for M which is diffuse over all of \mathbb{R} . The posterior density of M then becomes

$$f_M(\mu | x_1, \dots, x_n) = \frac{\sqrt{n}}{\sigma} \varphi\left(\frac{\mu - \bar{x}}{\sigma/\sqrt{n}}\right) \quad (3.2.13)$$

that is, the normal distribution with mean value \bar{x} and standard deviation σ/\sqrt{n} . It is worth noting the analogy with the estimator $\hat{\mu}$ in (3.2.2).

Since the conditional distribution function of X is

$$P(X \leq x | \mu) = \Phi\left(\frac{x - \mu}{\sigma}\right) \quad (3.2.14)$$

the total posterior distribution function is obtained as in (3.2.6) to

$$P(X \leq x | x_1, \dots, x_n) = \frac{\sqrt{n}}{\sigma} \int_{-\infty}^{\infty} \Phi\left(\frac{x - \mu}{\sigma}\right) \varphi\left(\frac{\mu - \bar{x}}{\sigma/\sqrt{n}}\right) d\mu \quad (3.2.15)$$

with the corresponding density function

$$\begin{aligned} f_X(x | x_1, \dots, x_n) &= \frac{\partial}{\partial x} P(X \leq x | x_1, \dots, x_n) = \frac{\sqrt{n}}{\sigma^2} \int_{-\infty}^{\infty} \varphi\left(\frac{x - \mu}{\sigma}\right) \varphi\left(\frac{\mu - \bar{x}}{\sigma/\sqrt{n}}\right) d\mu \\ &= \frac{1}{\sigma\sqrt{1+1/n}} \varphi\left(\frac{x - \bar{x}}{\sigma\sqrt{1+1/n}}\right) \end{aligned} \quad (3.2.16)$$

where the integral can be calculated by use of the standard formulas given in Remark 3.1.

The posterior density of X is seen to be normal with mean value \bar{x} and standard deviation $\sigma\sqrt{1+1/n}$. Thus the influence on X of the statistical uncertainty is that X , in stead of the unknown mean value μ , gets assigned the mean value \bar{x} and, in stead of the known standard deviation σ , gets assigned the larger standard deviation $\sigma\sqrt{1+1/n}$. The posterior density of X given the sample is called the *predictive density* of X . \square

Remark 3.1 The following formulas are often useful in calculations with the normal distribution densities:

$$\varphi\left(\frac{x - \mu_1}{\sigma_1}\right) \varphi\left(\frac{x - \mu_2}{\sigma_2}\right) = \varphi\left(\frac{\mu_1 - \mu_2}{\sqrt{\sigma_1^2 + \sigma_2^2}}\right) \varphi\left(\frac{x - \frac{\mu_1\sigma_2^2 + \mu_2\sigma_1^2}{\sigma_1^2 + \sigma_2^2}}{\frac{\sigma_1\sigma_2}{\sqrt{\sigma_1^2 + \sigma_2^2}}}\right) \quad (3.2.17)$$

$$\frac{1}{\sigma_1\sigma_2} \int_{-\infty}^{\infty} \varphi\left(\frac{x}{\sigma_1}\right) \varphi\left(\frac{z-x}{\sigma_2}\right) dx = \frac{1}{\sqrt{\sigma_1^2 + \sigma_2^2}} \varphi\left(\frac{z}{\sqrt{\sigma_1^2 + \sigma_2^2}}\right) \quad (3.2.18)$$

□

The failure probability can be interpreted as the mean value of a special function ψ of the random input variables. This is the function that takes the value 1 if the input variables take values that correspond to a point in the failure set and for all other points takes the value 0. For simplicity assume that X is the sole random input variable. Then we have the conditional failure probability

$$p_f(\mu) = E[\psi(X) | \mu] = \int_{-\infty}^{\infty} \psi(x) f_X(x | \mu) dx \quad (3.2.19)$$

and thus according to (3.2.6) the total failure probability

$$\begin{aligned} p_f &= \int_{\text{all } \mu} \left[\int_{-\infty}^{\infty} \psi(x) f_X(x | \mu) dx \right] f_M(\mu | x_1, \dots, x_n) d\mu \\ &= \int_{-\infty}^{\infty} \psi(x) \int_{\text{all } \mu} [f_X(x | \mu) f_M(\mu | x_1, \dots, x_n) d\mu] dx \\ &= \int_{-\infty}^{\infty} \psi(x) f_X(x | x_1, \dots, x_n) dx \end{aligned} \quad (3.2.20)$$

Thus we can either first calculate the conditional failure probability given $M = \mu$ and thereafter take care of the statistical uncertainty by unconditioning through use of the posterior density for the parameter M , or we can first include the statistical uncertainty directly in the input variable X to obtain its predictive distribution before the structural model is considered for the computation of the failure probability.

This is general and it depends on the mathematical properties whether the one procedure is more expedient than the other.

Exercise 3.1 Assume that a normal distribution with parameters μ_0, σ_0 can be assigned to M as the prior distribution. Use the formulas (3.2.17) and (3.2.18) to show that X has a normal predictive distribution with parameters

$$\frac{n\bar{x} + r\mu_0}{n+r} \quad \text{and} \quad \sigma \sqrt{\frac{n+r+1}{n+r}} \quad (3.2.21)$$

where $r = (\sigma/\sigma_0)^2$. By comparison with (3.2.16) it is seen that the chosen prior density gives an information contribution that in Example 3.2 corresponds to a sample of "size" r and with average μ_0 . □

Bayesian methods that take care of statistical uncertainty related to structural reliability will be treated more extensively in Chapter 11.

3.3 Model uncertainty

Besides the randomness and uncertainty adjoined to the input variables of the mechanical model set up for analysis, the reliability analysis must include the model uncertainty related to the formulation of the relevant limit state within the mechanical model.

The concept of limit state is defined in Section 2.1. Its definition will be repeated here. A limit state is a relation between the input variables that defines when the structure is just on the threshold to pass into a considered adverse event. In general a limit state can be defined by an equation $g(x_1, \dots, x_n) = 0$ in which g is some function of the input variables chosen such that $g(\mathbf{x}) > 0$ for all \mathbf{x} in the internal of the safe set, and $g(\mathbf{x}) < 0$ for \mathbf{x} in the internal of the adverse event (the failure set). Since only the boundary between the two sets $\mathcal{G} = \{\mathbf{x} | g(\mathbf{x}) = 0\}$ is uniquely defined by the mechanical model and the considered adverse event, the choice of the function g is not unique. For $n = 3$ the limit state \mathcal{G} is a surface. For general n we also denote \mathcal{G} as the limit-state surface. The particular function g chosen for its definition is called the limit-state function.

In the process of transforming a verbally formulated limit state into a mathematical model, a choice is made among several physical parameters. These are anticipated as having influence on the question of whether the structure is, in fact, in the physical state described by the verbal formulation as being either failure or no failure. If we let n variables x_1, \dots, x_n take part in the description of the reliability problem and there are more relevant variables than these, then a given point (x_1, \dots, x_n) is not for sure either a point in the failure set or a point in the safe set. By realizing the structure the neglected variables get values. If this assignment of values is of random nature, it is also a random event whether the given point (x_1, \dots, x_n) corresponds to failure or not. We can imagine that every time the neglected variables get values, the n -dimensional space of the mechanical model is divided into a safe set and a failure set. Thus the limit-state surface is realized as a random surface from some population of surfaces. A surface is selected from the population by the assignment of values to the neglected variables.

The reason that some physical variables are neglected in the model formulation can be either that they are not known (possibly they are beyond imagination) or if they are identified that they have quantitatively unknown influence and interplay with other variables. This means that it is not possible to eliminate the random fluctuations of the limit-state surface from realization to realization just by extending the dimensions of the space. In principle, however, it is possible to decrease the fluctuations of the limit-state surface in this way. Of course, this decrease is counteracted by the extra variables having random fluctuations from realization to realization.

The mathematical representation of a limit state gives rise to uncertainty beyond the fluctuations caused by the neglected variables. The limit state is formulated in terms of the chosen variables x_1, \dots, x_n by use of some more or less extensive set of known mathematical functions. Often these functions are generated by use of idealized mechanical models for the structure and its behavior. Moreover, they may be fitted to experimental observations of the failure behavior of some example structures. This mathematical idealization process induces a systematic error at any given location of the failure surface. Perhaps this error can be decreased by a more detailed model formulation. For the reliability analysis the point is, however, that both time limits and operational reasons dictate that in practice we must be content with some not too sophisticated level of detailing. Therefore a systematic error of unknown size will always be present. It must be taken into account quantitatively in the reliability analysis by use of suitable judgemental variables. With the superior point of view that all uncertainty contributions should be joined together in a rational and unified way, such judgemental variables are most appropriately given the status as random variables represented by a joint probability distribution.

The interpretation of a probability distribution that represents an error of a fixed but unknown

value is by a closer look not so fundamentally different from the interpretation of a probability distribution for a fluctuating quantity. This is because a probability distribution is always interpretable as a set of possibilities weighted relatively by the assigned probabilities. The practical problem faced when formulating a probabilistic model consists of establishing the knowledge that allows a choice of this set of possibilities. Updating by use of new information then changes the weights of those possibilities that are in conflict with the new information. In the statistical problem about getting knowledge about the mean value μ for a random variable X , we imagine that we are able to choose a set of possible values of μ representing our knowledge about μ in the form of the prior density $f_M(\mu)$. After getting the sample of X available we can reweight the set of possibilities by use of the rules of the mathematical probability theory to obtain a set of weighted possibilities described by the posterior density $f_M(\mu|\text{sample})$.

In the limit-state model-uncertainty problem the choice of the set of possibilities for the systematic error on the carrying capacity, say, can in experimental situations be reduced to the problem of assessing the statistical uncertainty. The difference between the calculated carrying capacity by use of the limit-state model and the observed carrying capacity defines a sample from a population, the mean value of which expresses the systematic model error. Such reported experimental investigations combined with investigations of more refined mechanical models give the basis of experience and the collective professional insight that in more general situations may allow a reasonable choice of the weighted set of possibilities. With a suitable probabilistic model formulation (based on certain hypotheses of regularity, of course) it is as for statistical uncertainty possible to update the model uncertainty of a given limit-state model on the basis of new information about both the position in the mean and the fluctuations of the "real" limit-state surface.

Remark 3.2 The advocated interpretation of the concept of probability as a weighted set of possibilities is exemplified in an illustrative way by considering the throw of a die. Obviously the set of possibilities can be taken to consist of the six numbers corresponding to the pips. However, the weights are not given a priori. If the die is assumed to be perfect (i.e. the die is fair), these possibilities are of equal weight. This assumption completely defines the probability distribution without it being necessary to observe just a single outcome of a throw. The model is completely given by a symmetry consideration induced by the assumption that the die is perfect.

Assume now that this supposition is not given. Imagine that a physicist gets detailed information of physical type about the die such as the variation of the mass density, elastic properties etc. Thereupon a single throw with the die is made without the physicist seeing the result. It is noted by a judge. The physicist is asked to come up with a probability distribution for the six possibilities. Since physical considerations show that the point of gravity of the die has an unsymmetrical position relative to the geometry of the die, the physicist will hardly suggest equal probabilities on the six possibilities.

A statistician gets the results from 10 repeated throws with the die and is asked the same question as the physicist. The statistician has only got the information that it cannot be taken for granted that the die is perfect. If the statistician follows a Bayesian approach, he or she will most likely choose the prior distribution to have equal weight on the six possibilities and then end up with a posterior distribution by using the results of the 10 throws. The answer will hardly be coincident with the answer from the physicist. Both answers are a weighted set of possibilities for the result known by the judge, a result that cannot be changed. Which of the two answers is the best can only

be decided if it has been decided how the correct set of weighted possibilities should be defined. In a situation as the considered where it is possible to repeat the throw with the same die independently a large number of times, it is natural to define the correct weighted set of possibilities as the distribution toward which the relative frequencies of the different outcomes gradually stabilize as the number of throws grows. It is, in fact, this distribution of relative frequencies which is the object of estimation by statistical methods that are based on the mathematical probability theory. With this definition of the correct weighted set of possibilities one can be misled to conclude that the answer from the statistician is the best of the two. However, the results from 10 throws with the die is only a small sample. Thus the statistical uncertainty is large. The answer of the physicist can therefore very well be better than that of the statistician. If the distribution assessed by the physicist is given to the statistician, he or she will no doubt consider the possibility of using this distribution as the prior distribution instead of the distribution of equal weights that just represents the lack of prior information.

Those situations are special where a correct set of weighted possibilities can be specifically defined a priori. Most often the correct weighted set of possibilities is an unknown object related to a supposed experiment in which repetitions are made over and over again. This supposed experiment leans itself to the properties of the probability theory as being able to lead to asymptotic probability distributions for sequences of random variables and, in particular, sequences of relative frequencies.

In the physical reality the possibilities of doing repetitions under equal conditions are usually very limited or even excluded in principle. In common for the probabilistic description of a fluctuation phenomenon and the uncertain knowledge about a fixed quantity is that the description is given in terms of a weighted set of possibilities. The difference is in the information on the basis of which the choice of the relative weights are made. The probability theory is able to predict relative frequencies and therefore the probabilistic model possesses a particular power of prediction for randomly fluctuating phenomena against which the goodness of the model can be tested. For unknown but fixed quantities there is no such direct possibility of comparison with results from repeated identical experiments.

A verification of the goodness of a method of judgment the results of which are expressed as a set of weighted possibilities must then necessarily be based on the experiences from repeated applications of the method: At each single application it can be noted whether an observable event occurs or not. The event may be specific to the application and it should be chosen in such a way that it in accordance with the method gets the probability p . In the sequence of applications of the method the relative frequency of the occurrence of the event can be observed at any time. The deviation between p and the observed relative frequency together with the number of applications then give some evidence about the goodness of the method of judgment in relation to the considered sequence of observable events. Too large deviations or lack of stabilizing tendency are signs of less usefulness of the method. When this is recognized through the obtained experiences, the requirement of rational behavior will in the long run enforce a revision of the method of judgment (that is, under the hypothesis that there is willingness to learn from experience). We will later refer to this requirement of rational behavior as "the long run revision principle".

The discussed comparison of calculated results with observed data is usually called verification of the model, even though verification (in contrast to falsification) of the strict truth of a model in

principle is impossible. The verification problem for a probabilistic model dealing with uncertain knowledge about a fixed quantity can be illustrated within the example with the physicist and the die.

Assume that the physicist several times is put to the considered judgemental problem but every time with a new die with its individual physical properties. He or she must every time come up with a probability that the judge has observed six pips in the one throw which is allowed for each die. Thus the physicist has after the judgment of the n first dice assessed the probabilities p_1, \dots, p_n . These are in the model of the physicist the same as the mean values of X_1, \dots, X_n , respectively. Here X_i is a random variable that takes the value 1 if the i th die shows six pips. Otherwise X_i takes the value 0. Then the relative frequency of the event of getting six pips is represented by the random variable $(X_1 + \dots + X_n)/n$. It has the mean value

$$E \left[\frac{1}{n} (X_1 + \dots + X_n) \right] = \frac{1}{n} (p_1 + \dots + p_n) \quad (3.3.1)$$

and the variance

$$\text{Var} \left[\frac{1}{n} (X_1 + \dots + X_n) \right] = \frac{1}{n^2} \sum_{i=1}^n \text{Var}[X_i] = \frac{1}{n^2} \sum_{i=1}^n p_i(1 - p_i) \leq \frac{1}{4n} \quad (3.3.2)$$

since X_1, \dots, X_n are mutually independent and

$$\text{Var}[X_i] = E[X_i^2] - E[X_i]^2 = E[X_i] - E[X_i]^2 = p_i - p_i^2 \quad (3.3.3)$$

It follows from (3.3.2) that the standard deviation of the relative frequency for any choice of the probabilities p_1, \dots, p_n decreases inversely proportional to \sqrt{n} . Thus the model predicts that the relative frequencies considered as functions of n is given by the right hand side of (3.3.1) asymptotically as $n \rightarrow \infty$. By comparison with the observed data it is therefore possible for the judge to evaluate the goodness of the judgment model of the physicist. \square

Example 3.3 Consider a snow loaded roof girder that is supported on two columns as shown in Figure 3.1. The analysis of this structure is made by an idealized mathematical model. In the model the girder is assumed to be a simply supported beam subjected to a uniformly distributed load intensity. This assumption implies two idealizations that influence the internal forces in the girder and the forces by which the girder acts on the columns. The one idealization concerns the assumption about simple support. It implies that the beam gets the axial force zero and that there is no horizontal action from the beam to the columns. Since the snow load acts vertically the real horizontal action is usually modest. (Horizontal actions on the columns can occur due to friction at the supports activated by the deformation of the beam caused by the vertical load). Thus there seems to be only small model uncertainty associated to the support assumption.

However, the girder of the real structure can be subjected to temperature variations or shrinkage that imply length changes of the girder. If the assumption about frictionless support is not particularly good these length changes may give horizontal displacements of the column tops. Without explicit consideration of the temperature variations or the shrinkage the model with simple support therefore can have considerable uncertainty. Its size naturally depends on the properties of the real support, of the rigidity of the columns, of the heat expansion coefficient and the shrinkage properties of the girder, and the size of the neglected temperature variations. This model uncertainty has

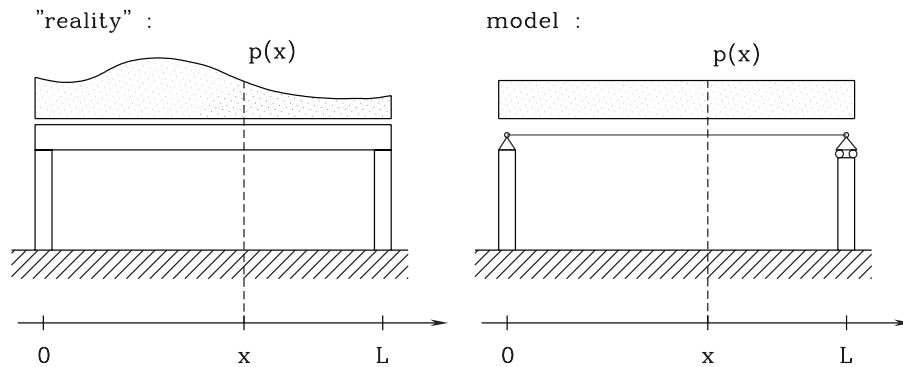

Figure 3.1: Idealized model for roof girder and snow load.

less importance for the reliability of the girder with respect to its own carrying capacity but it is quite important for the reliability of the columns.

The other idealization concerns the snow load. In the reality the snow is not uniformly distributed over the roof. The corresponding model uncertainty can be evaluated by comparison with the results from a more detailed load variation model. For example, the vertical load on the right column is in the model equal to $Lp/2$, while the “real” load distribution gives

$$F = \frac{1}{L} \int_0^L xp(x) dx = \frac{1}{2}L(p + J_p) \quad (3.3.4)$$

where

$$J_p = \frac{2}{L^2} \int_0^L x[p(x) - p] dx \quad (3.3.5)$$

except for small errors at the lower and the upper integration limit (at each limit an integration is missing over the half of the wall thickness).

If p is modeled independently of the considered building as a random variable on the basis of uniformly distributed snow layers on the soil surface, the stochastic properties assigned to p must be modified with respect to model uncertainty before they can be used in a reliability analysis carried out inside the universe of the idealized model. This model uncertainty concerns both a systematic change of the mean value and the variance from the soil surface to the roof surface and the non-uniform distribution of the snow on the roof surface. Moreover it depends on the type of load effect under consideration. If, for example, it is the bending moment in the center of the beam, the integrand $xp(x)$ in (3.3.4) is replaced by $Lxp(x)/2$ for $x < L/2$ and $L(L-x)p(x)/2$ for $x > L/2$.

The uncertain knowledge about $p(x)$ and thus about the correction term J_p can be modeled by letting J_p be a random variable with mean value and variance chosen by a suitable judgment. This judgment concerns the possibility of uneven distribution of the snow (dune formation) and the snow drift away from the roof for different wind directions and wind speeds. The judgment may naturally be supported on calculation of J_p according to (3.3.5) with use of different judgemental choices of $p(x) - p$.

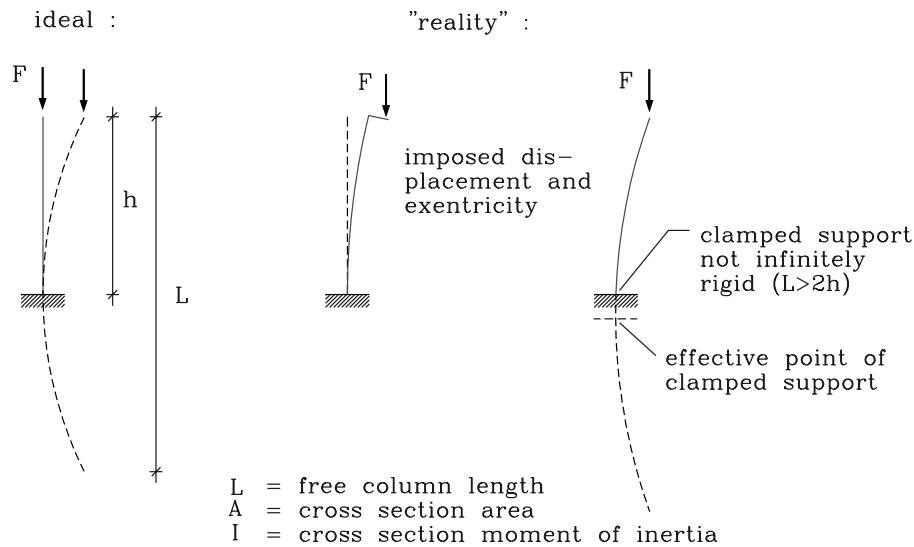

Figure 3.2: Column models with different degree of idealization.

In its simplest form the result can be expressed by a mean value $E[J_p]$, a variance $\text{Var}[J_p]$ and a covariance $\text{Cov}[p, J_p]$. Thereafter the reliability analysis can be carried out inside the simple model by replacing the given mean value $E[p]$ and the given variance $\text{Var}[p]$ of p with $E[p] + E[J_p]$ and $\text{Var}[p] + \text{Var}[J_p] + 2\text{Cov}[p, J_p]$, respectively. Most often consideration of model uncertainty has the consequence that the considered input variable (here p) gets a larger variance assigned to it.

Next let us look at the analysis of the right column in Figure 3.1. The most extensive idealization consists in letting the column be a straight centrally loaded column with clamp in support at the bottom and with free end at the top, Figure 3.2. Moreover it is a common idealization to assume that the column material has a linear elastic-ideal plastic constitutive law under compression with coefficient of elasticity E and compression yield stress σ_y . The theoretical carrying capacity P_u is then determined by the so-called Euler force $\pi^2 EI/L^2$, if this is less than the force $P_y = A\sigma_y$ that corresponds to compression yielding of the entire column cross-section.

The theory for centrally loaded columns from which this result follows assumes that the column is straight. If the column initially is just slightly curved (this is almost always the case for real columns) or it is not exactly centrally loaded, the axial force cannot increase in the column without simultaneous increase of the bending moments. This has the effect that the column reaches a maximal carrying capacity at a smaller normal force than the Euler force or the compression yield force. Moreover the theory assumes that the unloaded column is without eigenstresses. Real columns have eigenstresses caused by the production method. These eigenstresses cause that the strain-stress diagram obtained by averaging over the entire cross-section is not linear elastic-ideal plastic, but that there is a more or less curved transition between the linear elastic domain and the ideal plastic domain. The cross-section strain-stress curve thus depends on the state of eigenstresses which therefore also influences the carrying capacity of the column. This is because the carrying capacity and the derivative of the strain-stress curve at the carrying capacity value (the "effective coefficient of elasticity") are closely related (Engesser-Shanley theory). Figure 3.3 indicates

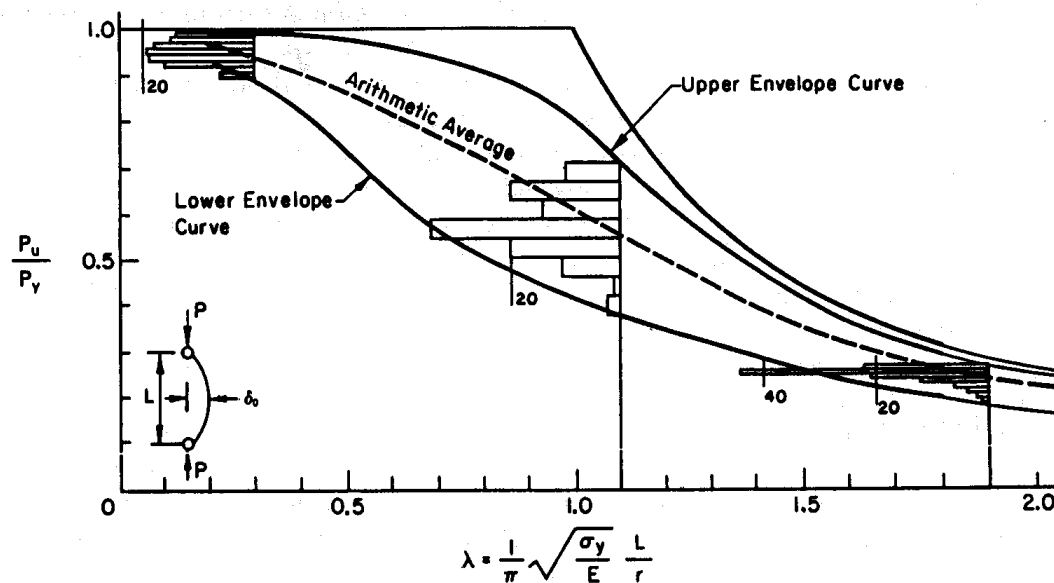

Figure 3.3: Statistical population of carrying capacity curves for steel columns with given initial curvature, from [3.2] reproduced by permission of Pitman Publishing Limited, London.

the results of 112 calculations of the ratio P_u/P_y as a function of the so-called reduced slenderness ratio λ (defined in the figure) for steel columns with a series of different cross-sectional shapes and steel qualities. In all cases the initial curvature of the column axis is given in terms of an arrow height of 1/1000 of the column length. The Euler force is represented by $1/\lambda^2$ (upper curve to the right hand side). The eigenstress distributions are based on measured data available in 1972. The calculations are made by R. Bjorhovde [3.1] and are referred in [3.2], from where the figure originates. The calculation results have been compared with measured results for corresponding experimental columns. It is stated that most of the measured results deviate less than 5% from the calculated results, that is, there is an uncertainty that corresponds to half to one unit (0.1) on the ordinate axis in Figure 3.3. If it is assumed that the 112 calculation results correspond to a representative sample of carrying capacity results for steel columns built in practice, the histograms in Figure 3.3 give an impression of the relevant model uncertainty related to a fixed idealized carrying capacity curve that determines P_u/P_y uniquely as a function of λ . Considering the deviations between the calculated values and the experimental data, the model uncertainty becomes even a little larger than indicated by the diagrams.

For the columns there is more to be added about the model uncertainty, however. The quantity L is the so-called free column length. If the clamp in support at the bottom is infinitely rigid and the upper end is totally free we have $L = 2h$ as shown to the left in Figure 3.2. If the clamp in support is just a little bit flexible the free column length becomes larger as indicated to the right in Figure 3.2. It is seen from Figure 3.3 that this implies a decreased carrying capacity. Thus the clamp in assumption can cause model uncertainty. The two column ends are connected by the girder such that displacement of the one column end will affect the other column end if the assumption of friction free support is not good.

All these model uncertainties necessarily must be considered in the reliability analysis in a suitable idealized form. The result will be a structure with larger dimensions than required if resources are used on formulating a less idealized model with associated model uncertainty. It is a question about economy and other criteria that influences the choice of dimensions whether it is worth the effort to make such a more detailed analysis.

The considerable model uncertainty associated to the column problem naturally invites for a more detailed investigation. In the steel structure codes of several countries more column curves are given. For example, the current Danish steel structure code gives 5 curves where the choice of the relevant curve depends on the cross-sectional form and the production method (rolled or welded profile).

The choice of the free column length by simple considerations concerning the support conditions is a source of uncertainty that often dominates the uncertainty associated to the choice of the column carrying capacity curve. This problem is a source not only to considerable model uncertainty but also to genuine mistakes (radical errors) that are caused by erroneous conceptions of the deformation and displacement properties of the structure. In general the reliability analysis does not account for such radical errors because often they are difficult to formulate in terms of a quantitative probabilistic model. The occurrence of radical errors will therefore not be characterized as model uncertainty. Prevention should be made by control measures directed towards the structural analysis itself. The problem of the influence of radical errors will be treated in detail in Chapter 12 about decision philosophy. In the present example and in other similar examples the danger of making mistakes concerning the free column length is decreased by studying the stability problem for the structure as an entity and not just the single columns separately. \square

Whatever degree of detailing and sophistication of the mathematical-mechanical model a model uncertainty will remain. Possibly this can be made so small that further decrease of the model uncertainty has no noticeable effect on the resulting reliability measure. This means that the contributions from the physical fluctuations and from other uncertainty sources (choice of probability distribution types, statistical uncertainty, measuring uncertainty, forecast of environment development etc.) dominate over the uncertainty of the mechanical model to such a degree that the considered sophistication hardly is reasonable if it implies an increase of the cost of the engineering design work. Information that only to a small degree influences the answer should in practice be considered as unnecessary information for the given problem.

3.4 Model-uncertainty evaluation and its inclusion in the reliability analysis*

Let the idealized limit-state surface \mathcal{G}_i be given in the space of input variables $\mathbf{x} = (x_1, \dots, x_n)$ by an equation $g(\mathbf{x}) = 0$, i.e.

$$\mathcal{G}_i = \{\mathbf{x} \mid g(\mathbf{x}) = 0\} \quad (3.4.1)$$

A continuously deformed version (a perturbation) of \mathcal{G}_i can be generated by use of a continuous one-to-one mapping

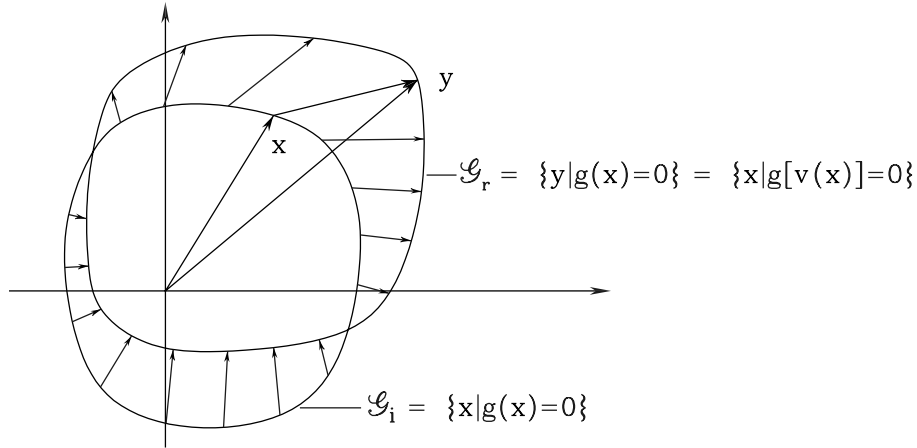

Figure 3.4: The vector field $\mathbf{y} - \mathbf{x} = \mathbf{w}(\mathbf{x}) - \mathbf{x} = \mathbf{y} - \mathbf{v}(\mathbf{y})$ that models the model uncertainty.

$$\mathbf{y} = \mathbf{w}(\mathbf{x}), \quad \mathbf{x} = \mathbf{v}(\mathbf{y}) \quad (3.4.2)$$

of the space onto itself with such properties that the image point \mathbf{y} of an arbitrary point $\mathbf{x} \in \mathcal{G}_i$ is suitably close to \mathbf{x} . The image surface of \mathcal{G}_i is then, see Figure 3.4,

$$\mathcal{G}_r = \{\mathbf{y} | g(\mathbf{x}) = 0 \wedge \mathbf{y} = \mathbf{w}(\mathbf{x})\} = \{\mathbf{y} | g[\mathbf{v}(\mathbf{y})] = 0\} = \{\mathbf{x} | g[\mathbf{v}(\mathbf{x})] = 0\} \quad (3.4.3)$$

We can imagine that the mapping is chosen so that \mathcal{G}_r becomes the “real” limit-state surface. We have already appreciated that the real limit-state surface can be considered as a surface drawn at random from a population of limit-state surfaces. Here we now see that this is equivalent with a draw of the mapping (3.4.2) at random from a population of mappings. Thus we can formulate the judgemental problem about evaluating the model uncertainty of the limit state as a problem about choosing a random vector field $\mathbf{W}(\mathbf{x}) - \mathbf{x} = \mathbf{y} - \mathbf{V}(\mathbf{y})$ which transforms the fixed idealized limit-state surface \mathcal{G}_i into the random “real” limit-state surface \mathcal{G}_r . If the idealized limit-state surface \mathcal{G}_i in shape and position is close to the real limit-state surface, then the random vector field in the mean is close to a field of zero vectors. Moreover, it will possess small standard deviations if the model uncertainty is small.

Let \mathcal{F}_i and \mathcal{F}_r denote the idealized and the real failure event, respectively. Then it is seen that

$$\mathbf{x} \in \mathcal{F}_r \Leftrightarrow \mathbf{V}(\mathbf{x}) \in \mathcal{F}_i \quad (3.4.4)$$

Thus we can by changing the input variables \mathbf{x} to the modified random “input variables” $\mathbf{V}(\mathbf{x})$ keep the failure set \mathcal{F} as the idealized failure set \mathcal{F}_i and the limit-state surface \mathcal{G} as the idealized limit-state surface \mathcal{G}_i .

The simplest example of a model-uncertainty vector field is obtained by defining

$$\mathbf{V}(\mathbf{x}) = \mathbf{x} + \mathbf{J} \quad (3.4.5)$$

where \mathbf{J} is a random vector which is independent of \mathbf{x} . This corresponds to a situation where the real limit-state surface is generated by a random parallel shift of the idealized limit-state surface. The random input vector \mathbf{X} is then replaced by the random vector $\mathbf{X} + \mathbf{J}$ in the reliability analysis.

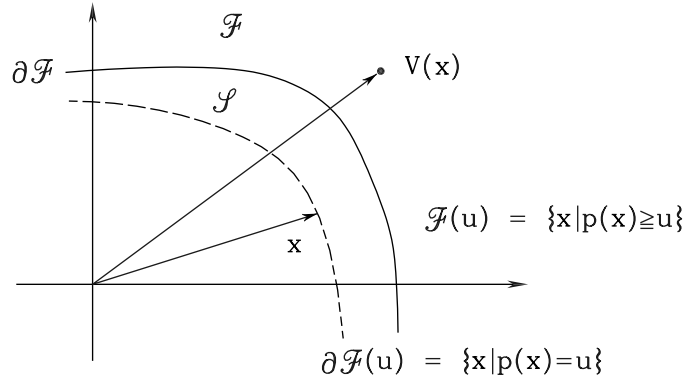

Figure 3.5: The set $\mathcal{F}(u)$ of \mathbf{x} for which the failure probability due to model uncertainty is larger than u .

A more flexible and less idealized model-uncertainty representation is obtained by the definition

$$\mathbf{V}(\mathbf{x}) = \mathbf{H}\mathbf{x} + \mathbf{J} \quad (3.4.6)$$

in which \mathbf{J} is as in (3.4.5) while \mathbf{H} is a random matrix which is independent of \mathbf{x} . This corresponds to a situation where the real limit-state surface is generated by a random parallel shift combined with a random affine mapping of the idealized limit-state surface. In the reliability analysis the random input vector \mathbf{X} is correspondingly replaced by the modified random input vector $\mathbf{H}\mathbf{X} + \mathbf{J}$.

These examples obviously represent the “real” limit-state surfaces by surfaces that in their shape are just as idealized as the idealized limit-state surface itself. However, as it will be demonstrated in the following, this type of idealization is less serious for the assessment of the measure of reliability. The essential contribution to the model uncertainty turns out to come from the representation of the random position of the limit-state surface (position in a particular sense to be explained later). The reason is that averaging takes place in the calculation so that the contributions from the random variations of the detailed shape of the limit-state surface are smoothed out.

Let us suppose that \mathbf{X} has the probability-density function $f_{\mathbf{X}}(\mathbf{x})$ and that the random vector field $\mathbf{V}(\mathbf{x})$ for each fixed \mathbf{x} has a well defined probability distribution. In principle it is then possible to determine the failure probability

$$p(\mathbf{x}) = P[\mathbf{V}(\mathbf{x}) \in \mathcal{F}] \quad (3.4.7)$$

for any given value \mathbf{x} of \mathbf{X} . The unconditional failure probability becomes

$$P[\mathbf{V}(\mathbf{X}) \in \mathcal{F}] = \int_{\mathbb{R}^n} p(\mathbf{x}) f_{\mathbf{X}}(\mathbf{x}) d\mathbf{x} = E[p(\mathbf{X})] \quad (3.4.8)$$

As a function of $u \in [0, 1]$ the probability of the event

$$\mathcal{F}(u) = \{\mathbf{x} | p(\mathbf{x}) \geq u\} \quad (3.4.9)$$

is the complementary distribution function of the random variable $U = p(\mathbf{X})$. This event is illustrated in Figure 3.5. By integration by parts we have

$$E[U] = \int_0^1 u f_U(u) du = 1 - \int_0^1 F_U(u) du = \int_0^1 P[\mathcal{F}(u)] du \quad (3.4.10)$$

such that (3.4.8) gives

$$\int_{\mathbb{R}^n} p(\mathbf{x}) f_{\mathbf{X}}(\mathbf{x}) d\mathbf{x} = \int_0^1 du \int_{\mathcal{F}(u)} f_{\mathbf{X}}(\mathbf{x}) d\mathbf{x} \quad (3.4.11)$$

The inner integral on the right side of (3.4.11)

$$\int_{\mathcal{F}(u)} f_{\mathbf{X}}(\mathbf{x}) d\mathbf{x} \quad (3.4.12)$$

can be interpreted as the failure probability corresponding to the assumption that $\mathcal{F}(u)$ is the failure set. Instead of considering the total population of possible limit-state surface it is therefore sufficient to work with a one-parameter population of "limit-state surfaces" defined by

$$\partial\mathcal{F}(U) = \{\mathbf{x} \mid p(\mathbf{x}) = U\} \quad (3.4.13)$$

Here U is a random variable which is uniformly distributed over the interval $]0, 1[$.

It is now a straightforward idea to identify the population of surfaces (3.4.13) by the population, see (3.4.3),

$$\{\mathbf{x} \mid g[\mathbf{v}(\mathbf{x}; U)] = 0\} \quad (3.4.14)$$

in which $\mathbf{v}(\mathbf{x}; U)$ is a particular simple vector field in the sense that the realization of the field is given when the value of U is given. According to (3.4.9) we have that

$$u_1 \leq u_2 \Rightarrow \mathcal{F}(u_1) \supset \mathcal{F}(u_2) \quad (3.4.15)$$

which means that $\mathcal{F}(u)$ is never increasing for u increasing. Therefore the vector field $\mathbf{v}(\mathbf{x}; U)$ as a function of u should satisfy a corresponding condition.

At this point we will refer to the theory of the first- and second-order reliability methods (FORM and SORM, Section 6.4) which shows that often it is only some centrally situated local parts of the limit-state surface that contribute essentially to the failure probability. With this in mind it follows that it is often sufficient to consider the model-uncertainty vector field in small domains of \mathbb{R}^n containing these most important parts of the limit-state surface. Within such a local domain it is usually sufficient to consider a vector field defined by, see (3.4.5),

$$\mathbf{v}(\mathbf{x}; U) = \mathbf{x} + \mathbf{J}z(U) \quad (3.4.16)$$

in which $z(u)$ is a suitably chosen increasing function of $u \in]0, 1[$, while \mathbf{J} is a constant vector, see Figure 3.6. The random variable $Z = z(U)$ has the distribution function

$$F_Z(x) = P(Z \leq z) = P[U \leq z^{-1}(x)] = z^{-1}(x) \quad (3.4.17)$$

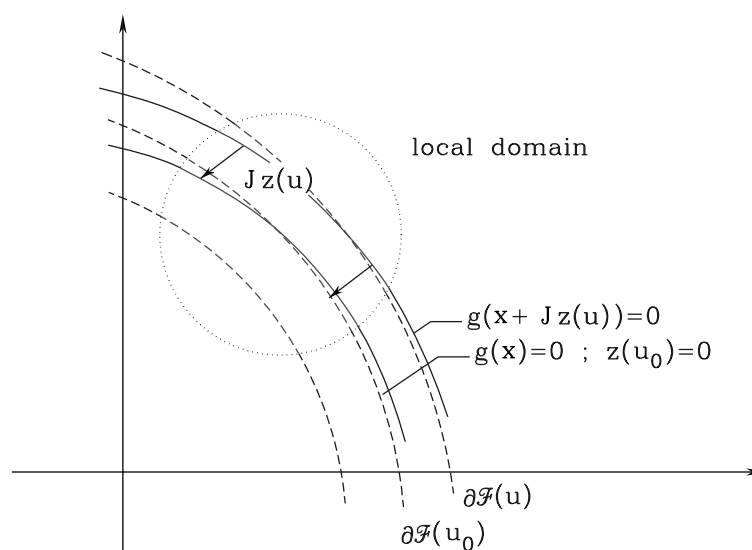

Figure 3.6: Model uncertainty representation within the essential local domain of the limit state surface.

with the inverse function

$$z(u) = F_Z^{-1}(u) \quad (3.4.18)$$

and Z is independent of the random input vector \mathbf{X} .

From this we can conclude that in all essentials we can take care of the model uncertainty solely by a simple modification of the distributional properties of the input vector.

The process of quantitative evaluation of the model uncertainty in specific examples belongs to the more difficult parts of the structural reliability analysis. This is due to the nature of the model uncertainty as an interplay between many different factors and also due to the fact that information about the model uncertainty is often scarce and fragmentary. In practice it will normally be a too difficult task for the individual engineer to exercise qualified judgments without considerable expertise. The problem of the model uncertainty evaluation cannot be neglected, however. It is therefore necessary that guidelines are given in a code of reference for the judgemental process together with quantitative information for the most common mechanical models and failure criteria.

3.5 Objectivity of the structural reliability analysis method *

Structural reliability with respect to some limit state is quantitatively expressed by a number on a suitable scale being related to a given time period. Taking for granted that the reliability evaluation is based on probabilistic modeling, the reliability measure scale is in one-to-one correspondence with the probability that the adverse event occurs within the considered time period.

The probability of the adverse event is calculated on the basis of the models set up for the different relevant randomnesses and uncertainties discussed in the previous sections. Several of

these submodels necessarily contain judgemental assessed elements including numerical values of parameters. They are of a personalistic (or subjective) nature. This fact can give the misleading impression that the entire probabilistic reliability evaluation method lacks objectivity and that the reliability measure is just the result of some academic hocus pocus.

The point is, however, that the objectivity of the model is not affected by the fact that its elements may be chosen with some degree of arbitrariness by judgment. Of course, to make sense this statement requires a definition of the concept of objectivity. Following G. Matheron [3.3] (who relies on K.R. Popper's *Logic of Scientific Discovery* [3.4]) the crucial criterion of objectivity of a statement is that in principle it can be falsified. A model set up with the intention that it should mirror some real world phenomenon is a compound statement which must satisfy the criterion that it can be put to the test of falsification. Otherwise it cannot carry information of empirical value.

There is a philosophical problem of how to falsify a probabilistic model. Matheron pragmatically suggests to use the principle of statistical hypothesis testing: if a *prespecified* event of relevance for the applications of the model has a calculated probability of very small magnitude, then the model is considered falsified with respect to the considered event if the event actually occurs in the corresponding real experiment. Since relevant adverse events in structural reliability by intentional design are given very small probabilities, a reliability model should be considered falsified with respect to its intended domain of application if one of the adverse design events actually occurs at or after the realization of the structure. The interpretation of this is that if the occurred structural adverse event after close investigation cannot be attributed to a radical error (mistake, gross error) which has caused a deviation from the theoretical design, then the reliability model is falsified, i.e. it contains most likely a radical error. We see that the concept of falsifiability for a probabilistic model gets a somewhat weaker meaning than for a deterministic model. This weaker concept may be called "pragmatic falsifiability". A probabilistic model does not exclude the occurrence of an event of very small probability, of course. In principle the model could be valid even if the event occurs. (In classical statistical hypothesis testing this is called the error of first kind: rejection of a true hypothesis). Therefore falsification of the model does not mean immediate rejection of the model but rather that it should be subject to a critical study possibly calling for a revision. The philosophical problem of falsifying a probabilistic model is simply removed by saying that *a probabilistic model is objective if it can be put to the test of pragmatic falsification*. This is sufficient to ensure that the model can carry information of empirical value and it is a condition for the applicability of the long-run revision principle (see Remark 3.2).

Structural reliability models differ from other types of probabilistic models in that their targets of interest are events of very small probability. The practical difficulty of performing the test of pragmatic falsification with such rare critical events enforces the principle of anticipatory modeling [3.3]. The striving for objectivity necessitates that the total reliability model be built from partial models that can be much more easily put to the test of pragmatic falsification and which are combined by operational rules that can be claimed to be objective, i.e. natural laws, rules of geometry, rules of probability calculus, etc.

Let us assume that consistently an engineer uses the probabilistic reliability analysis method based on the principle of anticipatory modeling and on his or her own judgemental assessments for the purpose of making rational design decisions. Because of the rarity of the relevant adverse events it is practically impossible for this individual engineer to get sufficient experience to follow

up with the principle of long-run revision. Nevertheless, due to the applied principle of anticipatory modeling the probabilistic reliability analysis method may still be considered as a rational formal tool of processing different types of personalistic knowledge about the structure and its environments into a single personalistic reliability measure that is useful for decision-making. It is obvious, however, that it is of concern to society that experiences from the entire activity of the engineering profession are gathered together in order to make the long-run principle of revision effective. It is also of concern to society to ensure protection of human lives and properties from less beneficial structural consequences of arbitrary ill-founded results of judgments or less professional guesses. Therefore rules for the game are set up in authorized codes of practice. To this day codes of practice around the world have basically been of deterministic type as described in Chapter 2. The principle of long-run revision, together with increasing requirements of being able to build more economical and more elegant structures, will no doubt in the near future lead to formulation of codes of practice for probabilistic reliability analysis. Such attempts are at present made, e.g. in the Joint Committee of Structural Safety, which has a basis of several international professional associations.

It is crucial for making the principle of long-run revision effective and for protection of the public that the reliability analysis methodology is kept free of arbitrary choices of elements to which the reliability measure is sensitive. Only empirical or internally objective choices [3.3] of elements should be left to the designer. This implies that the code should contain standardization of certain elements. These standardizations should at least include assumptions about distributional tails to be used in the reliability analysis.

Code revisions should not be made at too small time intervals, in order that experiences can be collected and processed. Due to the necessary standardization and, possibly, intended strong idealizations, the codified reliability model gets the character of a formal system for logical information processing for which the absolute failure probability values carry limited prediction power. With respect to empirical information they become formal probabilities that get their informational importance as means of comparisons with respect to reliability of different adverse events for the same or different structural solutions of a given building construction problem. That is, the probabilities of the adverse events primarily serve as indicators of a reliability ordering. This ordering makes it possible to formulate a statement such as "these two structures are equally reliable with respect to the adverse event A". The point dividing the probability scale into sufficiently reliable and insufficiently reliable structures with respect to event A is obtained by declaring some comparison standard to be just sufficiently reliable with respect to event A. The comparison standard is a specific limit state for a specific structural design and the declaration is given on the basis of a general consensus within an authorized code committee. Clearly the numerical value of the demarcation point on the probability scale depends on the chosen reliability model.

We see here that the objectivity criterion of pragmatic falsifiability needs an extension that specifies operationally how the imposed reliability ordering can be falsified. The requirement of objectivity can be satisfied in the long run by setting up a suitable strategy of code committee action that will put the reliability model to a test of pragmatic falsification. One such strategy of action, and possibly the only one, is to gradually change the comparison standard in the direction of less reliability. Eventually the reliability model will lead to designs that with some observable frequency will exhibit adverse behavior (a frequency which still can be less than the presently

observed frequency of adverse behavior due to mistakes). From data of observations of such adverse events it is in principle possible to set up a pragmatic falsification test of the reliability ordering. On this basis the principle of long-run revision can become active.

Bibliography

- [3.1] R. Bjorhovde (1972) *Deterministic and Probabilistic Approaches to the Strength of Steel Columns*, Ph.D. thesis, Department of Civil Engineering, Lehigh University, Bethlehem, PA, USA.
- [3.2] W.F. Chen and D.J. Han (1985) *Tubular Members in Offshore Structures*. Pitman Advanced Publishing Program, 1985, p. 72.
- [3.3] G. Matheron (1989) *Estimating and Choosing* (transl. by A.M. Hasofer), Springer Verlag, Berlin.
- [3.4] K.R. Popper (1972) *The Logic of Scientific Discovery*. Hutchinson, London.

This page is intentionally left blank.

Chapter 4

SIMPLE RELIABILITY INDEX

4.1 Limited probabilistic information

In this and the directly following chapters we will introduce a structural reliability concept that is based on a minimal number of elements from the probability calculus just necessary for having a model that makes it possible to perform rational calculations with uncertainties.

Accordingly we will presently assume that the random input variables solely are described by their so-called second-moment representation, that is, solely by their mean values, variances and covariances. By this only very weak direct assumptions are made about the type of their probability distributions, namely solely assumptions about the existence of mean values and variances.

This is convenient because most practical uncertainty evaluations are such that it will be out of the question to choose distribution types on the basis of solid data information. Pragmatic principles or code specifications become decisive for the choice of the distribution types. An uncertainty analysis that avoids such choices is therefore not without interest.

Moreover, the simple reliability analysis based on second-moment representations turns out to lead to calculation methods that with large effectivity are also applicable in reliability analyses that use full probabilistic information. Therefore it is useful to make oneself experienced in the fundamental algebra for second-moment representations. This chapter may also be helpful in this respect.

4.2 Calculus for linear safety margins

In this chapter we will consider the seemingly rather special case where the limit-state equation $g(x_1, \dots, x_n) = 0$ is linear in the input variables x_1, \dots, x_n . This means that the equation has the form

$$a_1x_1 + \dots + a_nx_n + b = 0, \quad b > 0 \quad (4.2.1)$$

where a_1, \dots, a_n, b are given constants. Consistent with the definition in Section 2.1 let the safe set be the set of those points in \mathbb{R}^n for which

$$a_1x_1 + \dots + a_nx_n + b > 0 \quad (4.2.2)$$

The surface determined by the equation (4.2.1) is a straight line if $n = 2$ and a plane if $n = 3$. For arbitrary n the surface is called a hyperplane. Usually a limit-state surface in a practical reliability analysis problem is not a hyperplane. However, in later chapters we shall see that it often is possible to obtain very accurate results by approximating the given not plane limit-state surface by one or more hyperplanes if the approximating hyperplanes are chosen in a particular way. The simplifications obtained in this way are substantial enough to justify a study of the reliability analysis for limit-state surfaces made up of at most a finite number of hyperplanes. The safe set defined by such a limit-state surface is said to be polyhedral. In the chapter "generalized reliability index" it is shown that particularly simple properties are obtained for polyhedral safe sets that are convex. This is an advantageous situation because particularly chosen convex polyhedral sets are often quite convenient in the reliability analysis as approximations to the given not necessarily convex safe set. (A set is convex if the point $\alpha\mathbf{x} + (1 - \alpha)\mathbf{y}$ belongs to the set for any choice of the points \mathbf{x} , \mathbf{y} within the set and for any $\alpha \in [0, 1]$). In this chapter we consequently concentrate on geometric calculations that concern hyperplanes. However, these geometric calculations will be formulated in the language of probability calculus and reliability analysis.

Assume now that uncertainty is assigned to the input variables x_1, \dots, x_n by modeling these as random variables X_1, \dots, X_n with given mean values

$$E[X_1], \dots, E[X_n] \quad (4.2.3)$$

and covariances defined by

$$\text{Cov}[X_i, X_j] = E[X_i X_j] - E[X_i]E[X_j] \quad (4.2.4)$$

These quantities jointly make up the concept of second-moment representation for the random vector $\mathbf{X} = (X_1, \dots, X_n)$. The particular covariances that corresponds to $i = j$ are the variances

$$\text{Var}[X_i] = \text{Cov}[X_i, X_i] = E[X_i^2] - E[X_i]^2, \quad i = 1, \dots, n \quad (4.2.5)$$

The vector of mean value is denoted as $E[\mathbf{X}]$ while the matrix of covariances conveniently is written as

$$\text{Cov}[\mathbf{X}, \mathbf{X}^T] = E[\mathbf{X}\mathbf{X}^T] - E[\mathbf{X}]E[\mathbf{X}^T] \quad (4.2.6)$$

preserving the rules of matrix algebra.

Remark 4.1 The calculation rules for mean values (expectations) originate from the definition of $E[\cdot]$ as a positive linear functional that maps the constant 1 into the number 1. The functional is defined on a linear space of random variables (symbolized by capital letters), with the constants inclusive (symbolized by lower-case letters). The calculation rules are

$$E[1] = 1 \quad (4.2.7)$$

$$E[aX] = aE[X] \quad (4.2.8)$$

$$E[X + Y] = E[X] + E[Y] \quad (4.2.9)$$

$$X \geq 0 \Rightarrow E[X] \geq 0 \quad (4.2.10)$$

The calculation rules for covariances follow directly from these rules through the use of the definition (4). It is seen that the covariance $\text{Cov}[\cdot, \cdot]$ is a symmetrical bilinear functional. The calculation rules are

$$\text{Cov}[X, Y] = \text{Cov}[Y, X] \quad (4.2.11)$$

$$\text{Cov}[aX, Y] = a\text{Cov}[X, Y] \quad (4.2.12)$$

$$\text{Cov}[X, Y + Z] = \text{Cov}[X, Y] + \text{Cov}[X, Z] \quad (4.2.13)$$

that completely correspond to the rules for an inner product (scalar product) between two vectors. Moreover the rule

$$\text{Cov}[a, X] = 0 \quad (4.2.14)$$

and the non-negativity rule

$$\text{Var}[X] = \text{Cov}[X, X] \geq 0 \quad (4.2.15)$$

are valid. The last rule follows from (4.2.14) and the definition (4.2.4) by writing

$$\text{Cov}[X, Y] = \text{Cov}[X - a, Y - b] = E[(X - a)(Y - b)] - E[X - a]E[Y - b] \quad (4.2.16)$$

and choosing $a = E[X]$ and $b = E[Y]$. Then

$$\text{Cov}[X, Y] = E[(X - E[X])(Y - E[Y])] \quad (4.2.17)$$

which for $X = Y$ and by use of (4.2.10) gives

$$\text{Cov}[X, X] = E[(X - E[X])^2] \geq 0 \quad (4.2.18)$$

It is seen that the constants under addition operations correspond to the zero vector when the covariance is interpreted as an inner product in the vector space of random variables.

For vectors of random variables the calculation rules can be formulated by use of the matrix algebra rules by the simple formulas

$$E[\mathbf{a}^T \mathbf{X}] = \mathbf{a}^T E[\mathbf{X}] \quad (4.2.19)$$

$$E[\mathbf{X} + \mathbf{Y}] = E[\mathbf{X}] + E[\mathbf{Y}] \quad (4.2.20)$$

$$\text{Cov}[\mathbf{X}, \mathbf{Y}^T]^T = \text{Cov}[\mathbf{Y}, \mathbf{X}^T] \quad (4.2.21)$$

$$\text{Cov}[\mathbf{a}^T \mathbf{X}, \mathbf{Y}^T] = \mathbf{a}^T \text{Cov}[\mathbf{X}, \mathbf{Y}^T] \quad (4.2.22)$$

$$\text{Cov}[\mathbf{X}, \mathbf{Y}^T + \mathbf{Z}^T] = \text{Cov}[\mathbf{X}, \mathbf{Y}^T] + \text{Cov}[\mathbf{X}, \mathbf{Z}^T] \quad (4.2.23)$$

$$\text{Cov}[\mathbf{X}, \mathbf{X}^T] \geq 0 \quad (4.2.24)$$

where ≥ 0 here means that the covariance matrix $\text{Cov}[\mathbf{X}, \mathbf{X}^T]$ is non-negative (all n eigenvalues are non-negative).

Moreover, from these formulas it follows that

$$\text{Cov}[\mathbf{a}^T \mathbf{X}, \mathbf{Y}^T \mathbf{b}] = \mathbf{a}^T \text{Cov}[\mathbf{X}, \mathbf{Y}^T] \mathbf{b} \quad (4.2.25)$$

$$\text{Cov}[\mathbf{A}\mathbf{X}, \mathbf{Y}^T \mathbf{B}^T] = \mathbf{A} \text{Cov}[\mathbf{X}, \mathbf{Y}^T] \mathbf{B}^T \quad (4.2.26)$$

where \mathbf{A} and \mathbf{B} are constant matrices. □

The equation (4.2.1) motivates the introduction of the random variable

$$M = a_1 X_1 + \dots + a_n X_n + b = \mathbf{a}^T \mathbf{X} + b \quad (4.2.27)$$

where $\mathbf{a}^T = [a_1 \dots a_n]$. The self-evident notation exemplified by (4.2.27) in which element notations in a natural way are shortened into vector notations will be used in the following without explicit display of the matrices. For outcomes of X in the internal of the safe set, on the limit-state surface, and in the internal of the failure set we have $M > 0$, $M = 0$ and $M < 0$, respectively. Such a random variable is called a safety margin or, more specifically, a linear safety margin. Its sign indicates if there is failure or no failure. However, its absolute value is arbitrary since the equation (4.2.1) is still valid after multiplication by an arbitrary constant. Of the same reason the mean value

$$E[M] = \mathbf{a}^T E[\mathbf{X}] + b \quad (4.2.28)$$

is arbitrary in the sense that it says nothing about the degree of safety. However, if the mean value $E[M]$ is divided by the standard deviation $D[M]$, which is defined as the square root of the variance

$$\text{Var}[M] = \mathbf{a}^T \text{Cov}[\mathbf{X}, \mathbf{X}^T] \mathbf{a} \quad (4.2.29)$$

we obtain a number

$$\beta = \frac{E[M]}{D[M]} = \frac{\mathbf{a}^T E[\mathbf{X}] + b}{\sqrt{\mathbf{a}^T \text{Cov}[\mathbf{X}, \mathbf{X}^T] \mathbf{a}}} \quad (4.2.30)$$

which is unchanged after multiplication of the safety margin with an arbitrary positive constant. The number β is even invariant under any regular inhomogeneous linear mapping of the random vector \mathbf{X} into another random vector \mathbf{Y} by

$$\mathbf{X} = \mathbf{B}\mathbf{Y} + \mathbf{c}, \quad \mathbf{Y} = \mathbf{B}^{-1}(\mathbf{X} - \mathbf{c}) \quad (4.2.31)$$

because M remains the same random variable whether or not it is written on the form (4.2.27) or on the form

$$M = (\mathbf{a}^T \mathbf{B})\mathbf{Y} + (b + \mathbf{a}^T \mathbf{c}) = \mathbf{a}_1^T \mathbf{Y} + b_1 \quad (4.2.32)$$

If in particular \mathbf{B} and \mathbf{c} are chosen such that

$$E[\mathbf{Y}] = \mathbf{0}, \quad \text{Cov}[\mathbf{Y}, \mathbf{Y}^T] = \mathbf{I} (= \text{unit matrix}) \quad (4.2.33)$$

we get

$$\beta = \frac{\mathbf{a}_1^T E[\mathbf{Y}] + b_1}{\sqrt{\mathbf{a}_1^T \text{Cov}[\mathbf{Y}, \mathbf{Y}^T] \mathbf{a}_1}} = \frac{b_1}{\sqrt{\mathbf{a}_1^T \mathbf{a}_1}} \quad (4.2.34)$$

The scalar product between the position vector to an arbitrary point \mathbf{x} on a hyperplane and the unit normal vector to the plane directed away from the origin is the same as the distance from the origin

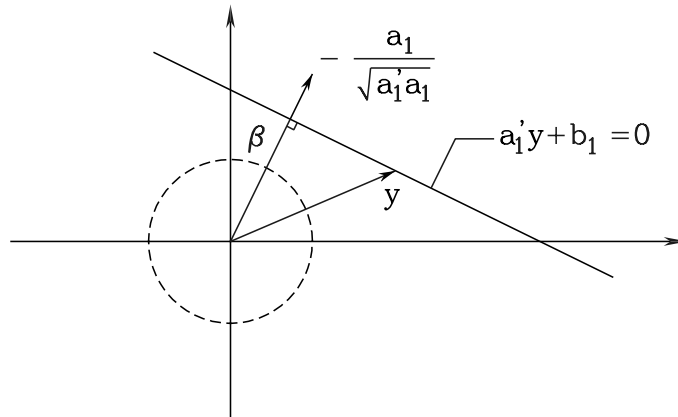

Figure 4.1: Geometric interpretation of the simple reliability index.

to the hyperplane. The normal vector to the hyperplane (4.2.1) is $-\mathbf{a}/\sqrt{\mathbf{a}^T\mathbf{a}}$ such that the distance becomes $-\mathbf{a}^T\mathbf{y}/\sqrt{\mathbf{a}^T\mathbf{a}} = b/\sqrt{\mathbf{a}^T\mathbf{a}}$.

Thus the number β is the distance from the origin to the limit state hyperplane in the particular mapping space that corresponds to (4.2.33), see Fig. 4.1. Until further this space will be called the normalized space. This space is rotation symmetric with respect to second-moment representation since any rotation about the origin given by an orthogonal matrix \mathbf{A} maps \mathbf{Y} at $\mathbf{Y}_1 = \mathbf{A}\mathbf{Y}$ with the covariance matrix

$$\text{Cov}[\mathbf{Y}_1, \mathbf{Y}_1^T] = \mathbf{A}\text{Cov}[\mathbf{Y}, \mathbf{Y}^T]\mathbf{A}^T = \mathbf{A}\mathbf{I}\mathbf{A}^T = \mathbf{A}\mathbf{A}^T = \mathbf{I} \quad (4.2.35)$$

The invariant number β can be interpreted as a measure of safety with respect to overpassing the limit state. According to its definition (4.2.30) it measures the distance from the limit state represented by $M = 0$ to the mean value $E[M]$ with the standard deviation $D[M]$ as unit. Having later extensions in mind we will denote β as the *simple reliability index*. However, in this chapter we will often leave out the word “simple”. If two limit states given by two different hyperplanes have the same reliability indices, they hereby formally gets assigned the same reliability. A condition that this reflects a reasonable engineering comparison with respect to safety between two limit states is that rotation symmetry with respect to second-moment representation in the normalized space also reflects rotation symmetry with respect to the conception of safety. With the assumption that the sole available information about the input variables \mathbf{X} is their second-moment representation this conceived rotation symmetry in safety must necessarily be present. If not, there should be available information about \mathbf{X} on the basis of which such asymmetry could be described and included in the safety evaluation. It should be emphasized that the mere knowledge that asymmetry is present without knowing the form of this asymmetry does not violate the claim of rotation symmetry with respect to safety. In Chapter 7 we will see how documented asymmetry can be taken care of by suitable transformations that remove the asymmetry.

Example 4.1 The truss tower in Fig. 4.2 carries a parabola antenna in a transmission line. The pseudo static load (P_1, P_2) is a correlated pair of random variables that balances the random wind pressure on the antenna [4.1]. In order that the antenna can function effectively it is required that

the rotation of the transmitted radio wave ray is kept under a certain level that depends on the distance to the next tower in the line. Since the load is random, the rotation also becomes random and it is proportional to the difference R between the horizontal displacements of the points 1 and 2. It is assumed that all bars are of the same elastic material with the coefficient of elasticity E and with the same cross sectional area A . By an elementary mechanical calculation we obtain that

$$R = [(5 + 2\sqrt{2})P_1 + P_2] \frac{a}{EA} \quad (4.2.36)$$

About the random properties of P_1 and P_2 it is assumed that the two forces have a common mean

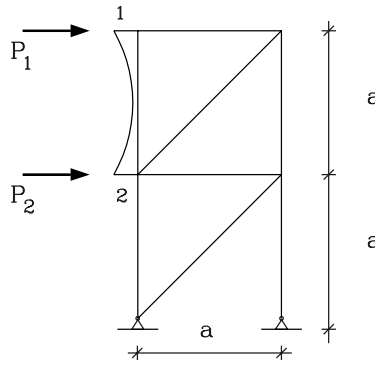

Figure 4.2: Truss tower with random loads from wind-excited parabola antenna.

value μ , standard deviation σ , and covariance $\rho\sigma^2$, where ρ is the so-called correlation coefficient $\text{Cov}[P_1, P_2]/(D[P_1]D[P_2])$. The correlation coefficient reflects the degree of spatial homogeneity of the wind velocity field. For example, if $\rho = 1$, it means that $\text{Var}[P_1 - P_2] = 0$. The random "rotation" R has the mean value

$$E[R] = (6 + 2\sqrt{2}) \frac{a\mu}{EA} \quad (4.2.37)$$

and the variance

$$\text{Var}[R] = [(5 + 2\sqrt{2})^2 + 1 + 2(5 + 2\sqrt{2})\rho] \left(\frac{a\sigma}{EA} \right)^2 \quad (4.2.38)$$

and thus the standard deviation

$$D[R] = \sqrt{62.3 + 15.7\rho} \frac{a\sigma}{EA} \quad (4.2.39)$$

The square root varies from 6.82 to 7.90 to 8.83 for $\rho = -1, 0$ and 1 , respectively. For these same three values and for the coefficient of variation $V_{P_1} = \sigma/\mu = 0.20$ the coefficient of variation $V_R = D[R]/E[R]$ is 0.15, 0.18 and $0.20 \leq V_{P_1} = V_{P_2}$, respectively. Thus the truss tower has the effect that it decreases the uncertainty of R relative to that of the input (P_1, P_2) .

As an example the design criteria specifications can be formulated in the following way: Choose the cross-section area A such that the numbers $E[R] - \beta D[R]$ and $E[R] + \beta D[R]$ for a given value of the simple reliability index β both belong to a given interval $[-\theta, \theta]$. The larger the

specified value of β the smaller the probability that the "rotation" R in a given strong wind gets outside the interval $[-\theta, \theta]$. By solution it is seen that the upper limit θ is the most critical and it is found that the requirement implies that

$$A \geq \left(8.83 + \beta \frac{\sigma}{\mu} \sqrt{62.3 + 15.7\rho}\right) \frac{a\mu}{E\theta} \quad (4.2.40)$$

For $\beta = 3$ and $\sigma/\mu = 0.2$ the just required cross-section area varies from 12.9 to 13.6 to 14.1 times $a\mu/E\theta$ for $\rho = -1, 0$ and 1 , respectively. In this case the design result is rather insensitive to the value of the correlation coefficient ρ . \square

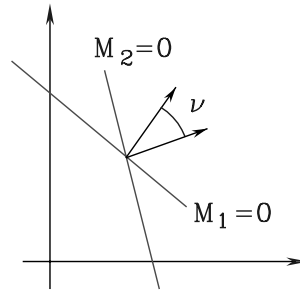

Figure 4.3: Geometric interpretation of the correlation coefficient ρ between two linear safety margins as $\rho = \cos \nu$.

We conclude this section by considering two linear safety margins

$$M_1 = \mathbf{a}_1^T \mathbf{X} + b_1, \quad M_2 = \mathbf{a}_2^T \mathbf{X} + b_2 \quad (4.2.41)$$

They are in a certain relation to each other by being correlated with the covariance

$$\text{Cov}[M_1, M_2] = \text{Cov}[\mathbf{a}_1^T \mathbf{X}, \mathbf{a}_2^T \mathbf{X}] = \mathbf{a}_1^T \text{Cov}[\mathbf{X}, \mathbf{X}^T] \mathbf{a}_2 \quad (4.2.42)$$

In several connections the *correlation coefficient* defined by

$$\rho[M_1, M_2] = \frac{\text{Cov}[M_1, M_2]}{D[M_1]D[M_2]} = \frac{\mathbf{a}_1^T \text{Cov}[\mathbf{X}, \mathbf{X}^T] \mathbf{a}_2}{\sqrt{\mathbf{a}_1^T \text{Cov}[\mathbf{X}, \mathbf{X}^T] \mathbf{a}_1} \sqrt{\mathbf{a}_2^T \text{Cov}[\mathbf{X}, \mathbf{X}^T] \mathbf{a}_2}} \quad (4.2.43)$$

has particular interest. Just as the simple reliability index is invariant, the correlation coefficient is invariant to an inhomogeneous linear mapping of \mathbf{X} into \mathbf{Y} . Choosing the particular mapping into the normalized space we get

$$\rho[M_1, M_2] = \left(-\frac{\mathbf{a}_1}{\sqrt{\mathbf{a}_1^T \mathbf{a}_1}}\right)^T \left(-\frac{\mathbf{a}_2}{\sqrt{\mathbf{a}_2^T \mathbf{a}_2}}\right) \quad (4.2.44)$$

where \mathbf{a}_1 and \mathbf{a}_2 here means the transformed coefficients in the safety margins M_1 and M_2 . From this it is seen that the correlation coefficient is the geometric quantity

$$\rho[M_1, M_2] = \cos \nu \quad (4.2.45)$$

where ν is the angle between the normal vectors to the two hyperplanes that correspond to the safety margins (Fig. 4.3). Both normal vectors are directed away from the origin. By specifying the two safety indices β_1 and β_2 and the correlation coefficient $\rho[M_1, M_2]$ the two hyperplanes therefore are completely determined relative to each other and to the origin in the normalized space.

4.3 Linear regression

In the next section we will consider some important geometric results that can be obtained by use of linear regression on linear safety margins. In spite that the concept of linear regression should be familiar to the reader from elementary probability calculus, we will introduce the concept from scratch in this section, but slightly more general than usual in elementary textbooks. This introduction solely requires that the reader knows about calculation rules for second-moment representations as repeated in Remark 4.1, and about elementary matrix algebra.

Without supposing that the random vectors considered in the following are vectors of input variables we consider a pair (\mathbf{X}, \mathbf{Y}) of random vectors. We want to approximate \mathbf{Y} linearly by \mathbf{X} such that the deviation in a certain sense becomes as small as possible. For an arbitrary coefficient matrix \mathbf{A} the deviation is $\mathbf{Y} - \mathbf{A}\mathbf{X}$. We will define the best approximation as the one for which there is no correlation between the deviation $\mathbf{Y} - \mathbf{A}\mathbf{X}$ and \mathbf{X} . Thus \mathbf{A} becomes determined from the condition

$$\text{Cov}[\mathbf{Y} - \mathbf{A}\mathbf{X}, \mathbf{X}^\top] = \text{Cov}[\mathbf{Y}, \mathbf{X}^\top] - \mathbf{A}\text{Cov}[\mathbf{X}, \mathbf{X}^\top] = \mathbf{0} \quad (4.3.1)$$

Assuming that the covariance matrix $\text{Cov}[\mathbf{X}, \mathbf{X}^\top]$ is regular we get

$$\mathbf{A} = \text{Cov}[\mathbf{Y}, \mathbf{X}^\top] \text{Cov}[\mathbf{X}, \mathbf{X}^\top]^{-1} \quad (4.3.2)$$

Since addition of an arbitrary constant vector to $\mathbf{A}\mathbf{X}$ does not affect the covariance, we can choose to add that particular constant vector \mathbf{a} that make the expectation of $\mathbf{A}\mathbf{X} + \mathbf{a}$ equal to the expectation of \mathbf{Y} . This gives

$$\mathbf{a} = E[\mathbf{Y}] - \mathbf{A}E[\mathbf{X}] \quad (4.3.3)$$

This linear approximation to \mathbf{Y} in terms of \mathbf{X} is called the *linear regression of \mathbf{Y} on \mathbf{X}* and is written as $\hat{E}[\mathbf{Y}|\mathbf{X}]$. Thus we have

$$\hat{E}[\mathbf{Y}|\mathbf{X}] = E[\mathbf{Y}] + \text{Cov}[\mathbf{Y}, \mathbf{X}^\top] \text{Cov}[\mathbf{X}, \mathbf{X}^\top]^{-1} (\mathbf{X} - E[\mathbf{X}]) \quad (4.3.4)$$

The deviation $\mathbf{Y} - \hat{E}[\mathbf{Y}|\mathbf{X}]$ is called the *residual vector*. The covariance matrix of the residual vector is

$$\text{Cov}[\mathbf{Y} - \hat{E}[\mathbf{Y}|\mathbf{X}], (\mathbf{Y} - \hat{E}[\mathbf{Y}|\mathbf{X}])^\top] = \text{Cov}[\mathbf{Y}, \mathbf{Y}^\top] - \text{Cov}[\mathbf{Y}, \mathbf{X}^\top] \text{Cov}[\mathbf{X}, \mathbf{X}^\top]^{-1} \text{Cov}[\mathbf{X}, \mathbf{Y}^\top] \quad (4.3.5)$$

and it is denoted as the *residual covariance matrix* or the *partial covariance matrix*. Addition of a vector of the form $\mathbf{B}\mathbf{X}$ to the residual gives

$$\begin{aligned} & \text{Cov}[(\mathbf{Y} - \hat{E}[\mathbf{Y}|\mathbf{X}]) + \mathbf{B}\mathbf{X}, (\mathbf{Y} - \hat{E}[\mathbf{Y}|\mathbf{X}])^\top + (\mathbf{B}\mathbf{X})^\top] = \\ & \text{Cov}[\mathbf{Y} - \hat{E}[\mathbf{Y}|\mathbf{X}], (\mathbf{Y} - \hat{E}[\mathbf{Y}|\mathbf{X}])^\top] + \mathbf{B}\text{Cov}[\mathbf{X}, \mathbf{X}^\top] \mathbf{B}^\top \end{aligned} \quad (4.3.6)$$

Since the covariance matrix $\text{Cov}[\mathbf{X}, \mathbf{X}^\top]$ is non-negative definite, the diagonal elements of the last term in (4.3.6) are non-negative. Thus the addition of $\mathbf{B}\mathbf{X}$ cannot decrease the diagonal elements of the covariance matrix to values below the values of the diagonal elements of the residual covariance matrix. In other words, the linear regression is also the best linear approximation to \mathbf{Y} in the sense of giving the smallest variances of the deviations.

The notation $\hat{E}[\mathbf{Y}|\mathbf{X}]$ is used because the linear properties of the mean value functional are also valid for the linear regression:

$$\hat{E}[\mathbf{a}|\mathbf{X}] = \mathbf{a} \quad (4.3.7)$$

$$\hat{E}[\mathbf{a}^\top \mathbf{Y}|\mathbf{X}] = \mathbf{a}^\top \hat{E}[\mathbf{Y}|\mathbf{X}] \quad (4.3.8)$$

$$\hat{E}[\mathbf{Y} + \mathbf{Z}|\mathbf{X}] = \hat{E}[\mathbf{Y}|\mathbf{X}] + \hat{E}[\mathbf{Z}|\mathbf{X}] \quad (4.3.9)$$

However, the positivity property (4.2.10) is not preserved. Moreover, we have that

$$\hat{E}[\mathbf{X}|\mathbf{X}] = \mathbf{X} \quad (4.3.10)$$

It follows from (4.3.4) that

$$E[\mathbf{Y}] = E[\hat{E}[\mathbf{Y}|\mathbf{X}]] \quad (4.3.11)$$

and that the last term in (4.3.5), except for the sign, is the covariance matrix for $\hat{E}[\mathbf{Y}|\mathbf{X}]$. Thus it follows from (4.3.5) that

$$\text{Cov}[\mathbf{Y}, \mathbf{Y}^\top] = \text{Cov}[\hat{E}[\mathbf{Y}|\mathbf{X}], \hat{E}[\mathbf{Y}|\mathbf{X}]^\top] + \text{Cov}[\mathbf{Y} - \hat{E}[\mathbf{Y}|\mathbf{X}], (\mathbf{Y} - \hat{E}[\mathbf{Y}|\mathbf{X}])^\top] \quad (4.3.12)$$

Example 4.2 Consider the measuring uncertainty problem in Example 3.1. We want to measure a quantity X but we observe $Z = X + Y$ where Y is the measurement error. In Example 3.1 it was assumed that X and Y are mutually independent. Here we will relax that assumption and instead assume that the linear regression

$$\hat{E}[Y|X] = aX + b \quad (4.3.13)$$

and the residual variance

$$\text{Var}[Y - \hat{E}[Y|X]] = \sigma^2 \quad (4.3.14)$$

are known. Then it follows by use of (4.3.9), (4.3.10) and (4.3.11) that

$$E[Z] = E[X + \hat{E}[Y|X]] = (1 + a)E[X] + b \quad (4.3.15)$$

and by use of (4.3.12) that

$$\text{Var}[Z] = \text{Var}[X + \hat{E}[Y|X]] + \sigma^2 = (1 + a)^2 \text{Var}[X] + \sigma^2 \quad (4.3.16)$$

Equations (4.3.15) and (4.3.16) give

$$E[X] = \frac{E[Z] - b}{1 + a} \quad (4.3.17)$$

$$\text{Var}[X] = \frac{\text{Var}[Z] - \sigma^2}{(1 + a)^2} \quad (4.3.18)$$

In a statistical sense we have hereby cleaned the measurement from measuring error. However, this method is disputable because the linear regression (that is, the constants a and b) and the residual variance may depend on the probability distribution of X .

Therefore the method is only applicable if there are reasons to assume that such dependency is not present. \square

Remark 4.2 The probability calculus introduces the concept of conditional mean value vector $E[\mathbf{Y}|\mathbf{X}]$ of \mathbf{Y} given \mathbf{X} . Besides (4.3.7) and (4.3.9) the more general form

$$E[\mathbf{g}(\mathbf{X})^\top \mathbf{Y}|\mathbf{X}] = \mathbf{g}(\mathbf{X})^\top E[\mathbf{Y}|\mathbf{X}] \quad (4.3.19)$$

of (4.3.8) is valid for the conditional mean vector. Here $\mathbf{g}(\cdot)$ is a vector of functions subject to very general restrictions. For the linear regression it is clear that (4.3.19) is not valid for other $\mathbf{g}(\cdot)$ than the constant vectors.

If $E[\mathbf{Y}|\mathbf{X}]$ is linear in \mathbf{X} , then $E[\mathbf{Y}|\mathbf{X}] = \hat{E}[\mathbf{Y}|\mathbf{X}]$. This follows from the fact that the conditional mean for given $\mathbf{X} = \mathbf{x}$ is the vector $E[\mathbf{Y}|\mathbf{x}]$ for which the elements in the vector of deviations $[\mathbf{Y}|\mathbf{x}] - E[\mathbf{Y}|\mathbf{x}]$ have minimal variances. Clearly this local minimality property carries over to the property of global minimality of $E[(\mathbf{Y} - \hat{E}[\mathbf{Y}|\mathbf{X}])^2]$ by averaging $[\mathbf{Y}|\mathbf{x}] - E[\mathbf{Y}|\mathbf{x}]$ over the set of values of \mathbf{X} weighted by the probability density of \mathbf{X} .

It will be shown in Section 4.5 that the conditional mean value $E[\cdot|\cdot]$ in the important case where (\mathbf{X}, \mathbf{Y}) has a multidimensional normal distribution is an extension of the linear regression. This means that $E[\cdot|\cdot]$ coincides with $\hat{E}[\cdot|\cdot]$ when the rule (4.3.19) is used solely on the form (4.3.8).

The analogous formulas to (4.3.11) and (4.3.12) become

$$E[\mathbf{Y}] = E[E[\mathbf{Y}|\mathbf{X}]] \quad (4.3.20)$$

$$\text{Cov}[\mathbf{Y}, \mathbf{Y}^\top] = \text{Cov}[E[\mathbf{Y}|\mathbf{X}], E[\mathbf{Y}|\mathbf{X}]^\top] + E[\text{Cov}[\mathbf{Y}, \mathbf{Y}^\top | \mathbf{X}]] \quad (4.3.21)$$

where $\text{Cov}[\mathbf{Y}, \mathbf{Y}^\top | \mathbf{X}]$ is the conditional covariance matrix for \mathbf{Y} given \mathbf{X} . Unlike the residual covariance matrix, the conditional covariance matrix may depend on \mathbf{X} . If $E[\mathbf{Y}|\mathbf{X}] = \hat{E}[\mathbf{Y}|\mathbf{X}]$ and the conditional covariance matrix is independent of \mathbf{X} then the conditional covariance matrix equals the residual covariance matrix.

The linear regression of \mathbf{Y} on \mathbf{X} with corresponding residual covariance matrix are global quantities that may depend on the distribution of \mathbf{X} while the conditional mean value vector $E[\mathbf{Y}|\mathbf{X}]$ and the conditional covariance matrix $\text{Cov}[\mathbf{Y}, \mathbf{Y}^\top | \mathbf{X}]$ are local quantities that may depend on \mathbf{X} but not on the distribution of \mathbf{X} . \square

Example 4.3 With reference to Remark 4.2 we see that the problem with the method of cleaning for measuring errors in Example 4.2 is due to the global character of the linear regression. However, if we assume that we know the local quantities $E[Y|X]$ and $\text{Var}[Y|X]$ as functions of X this problem is eliminated. In order to be able to use (4.3.20) and (4.3.21) without introduction of assumptions about probability distributions the conditional mean $E[Y|X]$ must have the linear form

$$E[Y|X] = aX + b \quad (4.3.22)$$

which leads to (4.3.17) while $\text{Var}[Y|X]$ at most can be quadratic in X , that is,

$$\text{Var}[Y|X] = \alpha X^2 + \beta X + \gamma \quad (4.3.23)$$

It is left to the reader as an exercise to find the formula for $\text{Var}[X]$ analogous to (4.3.18) by use of (4.3.20)-(4.3.23). \square

Example 4.4 In order to set up a non-destructive testing method for structural concrete elements we imagine that the strain-stress curves have been measured for a large number of test cylinders [4.1]. These test cylinders are all produced according to the same concrete recipe but each from its own mixture. From each strain-stress curve an observation of (X_1, X_2, X_3, Y) is obtained where, as shown in Figure 4.4, X_1, X_2 and X_3 are the stresses corresponding to 0.02, 0.04 and 0.06 % strain, respectively, while Y is the compression strength of the cylinder. By a statistical analysis of these results the following second-moment representation has been obtained:

$$E[[X_1 X_2 X_3 Y]] = [475 \ 893 \ 1250 \ 2295] \text{ N/cm}^2 \quad (4.3.24)$$

$$D[[X_1 X_2 X_3 Y]] = [35 \ 63 \ 90 \ 178] \text{ N/cm}^2 \quad (4.3.25)$$

$$\text{Corr}[\mathbf{X}, \mathbf{X}^T] = \begin{bmatrix} 1 & 0,843 & 0,762 \\ 0,843 & 1 & 0,967 \\ 0,843 & 0,967 & 1 \end{bmatrix}, \quad \mathbf{X} = \begin{bmatrix} X_1 \\ X_2 \\ X_3 \end{bmatrix} \quad (4.3.26)$$

$$\text{Corr}[Y, \mathbf{X}^T] = [0,387 \ 0,751 \ 0,835] \quad (4.3.27)$$

We introduce the notation $D[\mathbf{X}]$ (or $D[\mathbf{X}^T]$) for the diagonal matrix that has the standard deviations of the elements of \mathbf{X} in the diagonal and write

$$\text{Cov}[\mathbf{X}, \mathbf{X}^T] = D[\mathbf{X}]\text{Corr}[\mathbf{X}, \mathbf{X}^T]D[\mathbf{X}^T] \quad (4.3.28)$$

$$\text{Cov}[\mathbf{X}, Y] = D[\mathbf{X}]\text{Corr}[\mathbf{X}, Y]D[Y] \quad (4.3.29)$$

We will calculate the linear regression of Y on \mathbf{X} . The factor to $\mathbf{X} - E[\mathbf{X}]$ in (4.3.4) becomes

$$\begin{aligned} \text{Cov}[Y, \mathbf{X}^T]\text{Cov}[\mathbf{X}, \mathbf{X}^T]^{-1} &= D[Y]\text{Corr}[Y, \mathbf{X}]\text{Corr}[\mathbf{X}, \mathbf{X}^T]^{-1}D[\mathbf{X}]^{-1} = \\ D[Y][&-0,639 \ 0,175 \ 1,153]D[\mathbf{X}]^{-1} \end{aligned} \quad (4.3.30)$$

and thus

$$\begin{aligned} \hat{E}[Y|\mathbf{X}] &= 2295 + 178 \left(-0,639 \frac{X_1 - 475}{35} + 0,175 \frac{X_2 - 893}{63} + 1,153 \frac{X_3 - 1250}{90} \right) = \\ &547 - 3,250X_1 + 0,494X_2 + 2,280X_3 \text{ N/cm}^2 \end{aligned} \quad (4.3.31)$$

The residual variance follows from (4.3.5) as

$$\begin{aligned} \text{Var}[Y - \hat{E}[Y|\mathbf{X}]] &= \text{Var}[Y](1 - \text{Corr}[Y, \mathbf{X}^T]\text{Corr}[\mathbf{X}, \mathbf{X}^T]^{-1}\text{Corr}[\mathbf{X}, Y]) = \\ &\text{Var}[Y](1 - \text{Corr}[\mathbf{X}; Y]^2) \end{aligned} \quad (4.3.32)$$

where

$$\text{Corr}[\mathbf{X}; Y] = \sqrt{\text{Corr}[Y, \mathbf{X}^T]\text{Corr}[\mathbf{X}, \mathbf{X}^T]^{-1}\text{Corr}[\mathbf{X}, Y]} \quad (4.3.33)$$

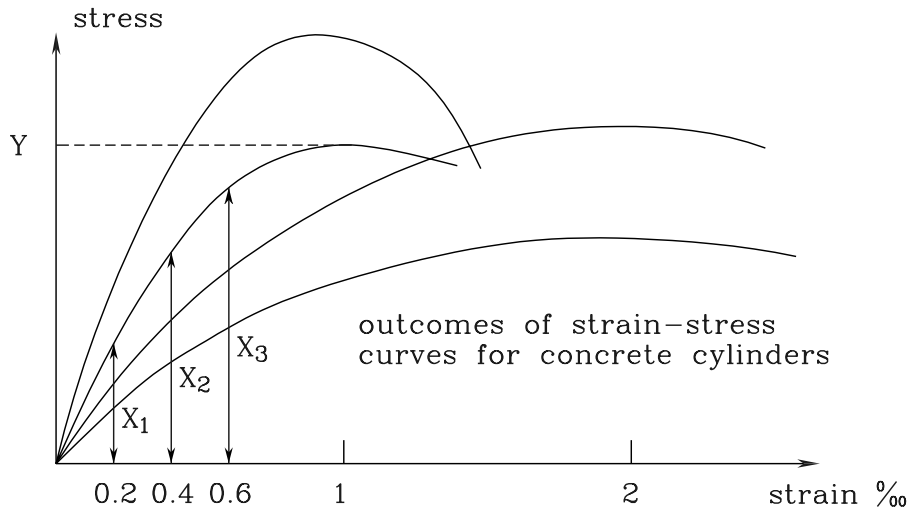

Figure 4.4: Forecasting of concrete stress-strain curves on the basis of measured values for small strains.

(which is also written as $\text{Corr}[Y; \mathbf{X}]$) is called the multiple correlation coefficient between \mathbf{X} and Y . In this example $\text{Corr}[\mathbf{X}; Y]^2 = 0.847$ such that the reduction factor on the standard deviation $D[Y]$ becomes

$$\frac{D[Y - \hat{E}[Y | \mathbf{X}]]}{D[Y]} = \sqrt{1 - 0.847} = 0.391 \quad (4.3.34)$$

A short concrete pillar is made according to the same recipe and is designed to carry a given load with a simple reliability index value of 4. For a given load the stress in the pillar therefore is equal to the mean value minus 4 times the standard deviation of the compression strength, that is, $2295 - 4 \cdot 178 = 1583 \text{ N/cm}^2$. After the concrete pillar has been cast but before the load has been applied doubt has been raised of whether the safety requirement is satisfied of having a simple reliability index value of at least 4. Therefore it is decided to make a test loading of the pillar up to a strain of 0.06 %. By this test loading, the observation $(X_1, X_2, X_3) = (353, 655, 958) \text{ N/cm}^2$ is obtained. The linear regression then gives the prediction 1908 N/cm^2 for the compression strength of the pillar and the simple reliability index becomes

$$\beta = \frac{1908 - 1583}{0.391 \cdot 178} = 4.67 \quad (4.3.35)$$

This indicates that the reliability is more than sufficient even though the predicted strength is about 17 % less than the design mean strength of 2295 N/cm^2 .

The same procedure is applicable if for some reason it is needed to put more load than planned on a structural element. \square

Exercise 4.1 Let \mathbf{X}_0 be a subvector of \mathbf{X} (that is, \mathbf{X}_0 has at most the same dimension as \mathbf{X} and all elements of \mathbf{X}_0 are also elements of \mathbf{X}). Show that

$$\hat{E}[\mathbf{X}_0 | \mathbf{X}] = \mathbf{X}_0 \quad (4.3.36)$$

and next that

$$\hat{E}[\hat{E}[Y|\mathbf{X}_0]|\mathbf{X}] = \hat{E}[Y|\mathbf{X}_0] \quad (4.3.37)$$

□

4.4 Geometric calculations by use of linear regression

In Section 4.2 we have seen that the simple reliability index

$$\beta = \frac{E[M]}{D[M]} \quad (4.4.1)$$

has the geometric property of being the distance from the origin to the hyperplane H in the normalized space, where H is defined by $M = 0$. The vector from the origin to its projection on the hyperplane is $\beta\alpha$, where $\alpha = -\mathbf{a}/\sqrt{\mathbf{a}^T\mathbf{a}}$ is the normal unit vector to H directed away from the origin.

This projection point is the point in the normalized space that reasonably can be denoted as the most central outcome of the random vector \mathbf{X} given that the linear safety margin

$$M = \mathbf{a}^T\mathbf{X} + b \quad (4.4.2)$$

takes the value $M = 0$. It is therefore interesting to check how this natural choice of the most central point on the hyperplane is related to the approximation to \mathbf{X} as obtained by the linear regression of \mathbf{X} on M . According to (4.3.4) we have that

$$\hat{E}[\mathbf{X}|M] = E[\mathbf{X}] + \frac{\text{Cov}[\mathbf{X}, M]}{\text{Var}[M]}(M - E[M]) \quad (4.4.3)$$

and thus

$$\hat{E}[\mathbf{X}|M=0] = E[\mathbf{X}] - \frac{\text{Cov}[\mathbf{X}, M]}{\text{Var}[M]}E[M] = E[\mathbf{X}] - \frac{\text{Cov}[\mathbf{X}, \mathbf{X}^T]}{\sqrt{\mathbf{a}^T\text{Cov}[\mathbf{X}, \mathbf{X}^T]\mathbf{a}}}\mathbf{a}\beta \quad (4.4.4)$$

In particular when the space is normalized, that is, when $E[\mathbf{X}] = 0$ and $\text{Cov}[\mathbf{X}, \mathbf{X}^T] = \mathbf{I}$, we get

$$\hat{E}[\mathbf{X}|M=0] = -\beta\frac{\mathbf{a}}{\sqrt{\mathbf{a}^T\mathbf{a}}} \quad (4.4.5)$$

This is exactly the projection point of the origin on the hyperplane H given by $M = 0$. Without necessarily assigning the concepts solely to the normalized space we will in the following denote the point given by (4.4.4) as the *most central failure point* on the plane limit state given by $M = 0$.

Linear regression can be used to determine the position vector not just from the zero point to the nearest point on a hyperplane H in the normalized space, but more generally from the origin to the nearest point \mathbf{x}_0 of the intersection $H_1 \cap \dots \cap H_p$ between p hyperplanes

$$H_i : M_i = 0, \quad i = 1, \dots, p \quad (4.4.6)$$

where M_1, \dots, M_p are the corresponding linear safety margins. If these are collected in the vector \mathbf{M} we have that the position vector is, see (4.3.4),

$$\hat{E}[\mathbf{X}|\mathbf{M}=\mathbf{0}] = -\text{Cov}[\mathbf{X}, \mathbf{M}^\top] \text{Cov}[\mathbf{M}, \mathbf{M}^\top]^{-1} E[\mathbf{M}] \quad (4.4.7)$$

assuming that the covariance matrix $\text{Cov}[\mathbf{M}, \mathbf{M}^\top]$ between the safety margins is regular. This is valid when the rank of the coefficient matrix \mathbf{A} in

$$\mathbf{M} = \mathbf{A}\mathbf{X} + \mathbf{b} \quad (4.4.8)$$

is the maximal rank p . This means that no one of the hyperplanes H_1, \dots, H_p can be removed from the intersection $H_1 \cap \dots \cap H_p$ without making the intersection larger. That (4.4.7) is the same as

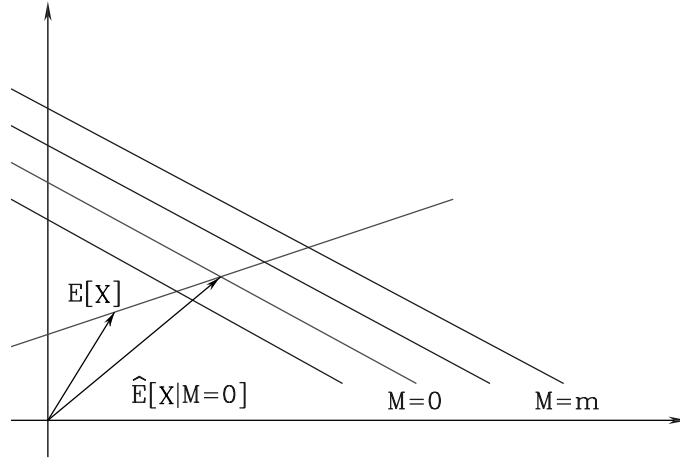

Figure 4.5: Geometric interpretation of linear regression $\hat{E}[\mathbf{X}|\mathbf{M}=\mathbf{0}]$.

\mathbf{x}_0 is seen by determining \mathbf{x}_0 as the point \mathbf{x} for which $\mathbf{x}_0^\top \mathbf{x}_0$ is minimal under the side condition $\mathbf{A}\mathbf{x} + \mathbf{b} = \mathbf{0}$. By use of the Lagrange multiplier $\boldsymbol{\lambda}$ this conditional minimum is determined as the unconditional minimum of the function

$$g(\mathbf{x}, \boldsymbol{\lambda}) = \mathbf{x}^\top \mathbf{x} + 2(\mathbf{A}\mathbf{x} + \mathbf{b})^\top \boldsymbol{\lambda} \quad (4.4.9)$$

We have

$$\frac{1}{2} \left\{ \frac{\partial g(\mathbf{x}, \boldsymbol{\lambda})}{\partial x_i} \right\} = \mathbf{x} + \mathbf{A}^\top \boldsymbol{\lambda} = \mathbf{0} \quad (4.4.10)$$

which upon multiplication by \mathbf{A} gives

$$\mathbf{A}\mathbf{x} + \mathbf{A}\mathbf{A}^\top \boldsymbol{\lambda} = \mathbf{0} \quad (4.4.11)$$

Since $\mathbf{A}\mathbf{A}^\top$ is regular and $\mathbf{A}\mathbf{x} = -\mathbf{b}$, it follows that $\boldsymbol{\lambda} = (\mathbf{A}\mathbf{A}^\top)^{-1} \mathbf{b}$, and thus from (4.4.10) that

$$\mathbf{x}_0 = -\mathbf{A}^\top (\mathbf{A}\mathbf{A}^\top)^{-1} \mathbf{b} \quad (4.4.12)$$

In the normalized space we have $\text{Cov}[\mathbf{M}, \mathbf{M}^\top] = \mathbf{A}\text{Cov}[\mathbf{X}, \mathbf{X}^\top]\mathbf{A}^\top = \mathbf{A}\mathbf{A}^\top$, $\text{Cov}[\mathbf{X}, \mathbf{M}^\top] = \text{Cov}[\mathbf{X}, \mathbf{X}^\top]\mathbf{A}^\top = \mathbf{A}^\top$, and $E[\mathbf{M}] = \mathbf{A}E[\mathbf{X}] + \mathbf{b} = \mathbf{b}$. Thus (4.4.7) and (4.4.12) are identical in this space.

We can generalize the formula (4.4.7) further such that we can determine the position vector from the point $\hat{E}[\mathbf{X}|\mathbf{M} = \mathbf{0}]$ in the intersection $H_1 \cap \dots \cap H_p$ to the nearest point in the intersection $H_1 \cap \dots \cap H_p \cap H_{p+1} \cap \dots \cap H_{p+q}$ where H_{p+1}, \dots, H_{p+q} are q hyperplanes determined by the linear safety margins N_1, \dots, N_q collected in the vector \mathbf{N} . This position vector becomes

$$\hat{E}[\mathbf{X}|\mathbf{M} = \mathbf{0}, \mathbf{N} = \mathbf{0}] - \hat{E}[\mathbf{X}|\mathbf{M} = \mathbf{0}] = \hat{E}[\mathbf{X} - \hat{E}[\mathbf{X}|\mathbf{M} = \mathbf{0}]|\mathbf{M} = \mathbf{0}, \mathbf{N} = \mathbf{0}] \quad (4.4.13)$$

which follows by use of (4.3.9) and (4.3.37).

In the special case where $q = 1$ the length in the normalized space of the vector (4.4.13) can be determined as the *conditional reliability index*

$$\beta_{N|\mathbf{M}=\mathbf{0}} = \frac{\hat{E}[N|\mathbf{M} = \mathbf{0}]}{\hat{D}[N|\mathbf{M} = \mathbf{0}]} \quad (4.4.14)$$

in which we have written N_1 as N . The numerator is determined by the linear regression

$$\hat{E}[N|\mathbf{M}] = E[N] + \text{Cov}[N, \mathbf{M}^\top]\text{Cov}[\mathbf{M}, \mathbf{M}^\top]^{-1}(\mathbf{M} - E[\mathbf{M}]) \quad (4.4.15)$$

by setting $\mathbf{M} = \mathbf{0}$, and the denominator $\hat{D}[N|\mathbf{M} = \mathbf{0}]$ is the square root of the residual variance, see (4.3.32) and (4.3.33),

$$\text{Var}[N](1 - \text{Corr}[N; \mathbf{M}]^2) \quad (4.4.16)$$

where

$$\text{Corr}[N; \mathbf{M}]^2 = (\text{Cov}[N, \mathbf{M}^\top]\text{Cov}[\mathbf{M}, \mathbf{M}^\top]^{-1}\text{Cov}[\mathbf{M}, N])\text{Var}[N]^{-1} \quad (4.4.17)$$

A proof of (4.4.14) is given at the end of Section 4.5.

4.5 The standardized multidimensional normal distribution

Let X_1, \dots, X_n be mutually independent random variables each of which is distributed as the standardized normal density

$$\varphi(x) = \frac{1}{\sqrt{2\pi}} \exp\left(-\frac{1}{2}x^2\right), \quad x \in \mathbb{R} \quad (4.5.1)$$

Then the joint density of all variables is

$$f_{\mathbf{X}}(\mathbf{x}) = \varphi(x_1) \dots \varphi(x_n) = \left(\frac{1}{\sqrt{2\pi}}\right)^n \exp\left(-\frac{1}{2}(x_1^2 + \dots + x_n^2)\right), \quad \mathbf{x} \in \mathbb{R}^n \quad (4.5.2)$$

This density is called the *standardized normal density in the n -dimensional space* (centered at the origin) and \mathbf{X} is said to be n -dimensional standard normal. The density (4.5.2) is constant

on the hypersphere $\mathbf{x}^T \mathbf{x} = r^2$ with center at the origin and radius r . The density varies with the distance $\|\mathbf{x}\|$ from the origin proportionally to the standardized one-dimensional normal density. The restriction of the density function to an arbitrary linear subspace of \mathbb{R}^n varies in the same way with the distance from the origin. If the set of points in the considered subspace is parallel shifted by a vector \mathbf{x}_0 that is orthogonal to all position vectors of the subspace, the restriction of (4.5.2) to this parallel shifted set also varies as the standardized one-dimensional normal density with the distance from the origin \mathbf{x}_0 of the shifted space. This follows from the identity

$$\exp\left(-\frac{1}{2}\|\mathbf{x}\|^2\right) = \exp\left(-\frac{1}{2}(\|\mathbf{x}_0\|^2 + \|\mathbf{x} - \mathbf{x}_0\|^2)\right) \propto \exp\left(-\frac{1}{2}\|\mathbf{x} - \mathbf{x}_0\|^2\right) \quad (4.5.3)$$

Thus we have shown that the standardized normal n -dimensional density as density for the random vector \mathbf{X} has the property that the conditional distribution of \mathbf{X} given that

$$\mathbf{A}\mathbf{X} + \mathbf{b} = \mathbf{0} \quad (4.5.4)$$

is the standardized normal m -dimensional density centered at \mathbf{x}_0 . The dimension is $m = n - p$ where p is the rank of the matrix \mathbf{A} while \mathbf{x}_0 is the orthogonal projection of the origin on the shifted m -dimensional subspace $H_1 \cap \dots \cap H_p$ given by the condition

$$\mathbf{A}\mathbf{x} + \mathbf{b} = \mathbf{0} \quad (4.5.5)$$

In this condition the i th equation defines the hyperplane H_i , $i = 1, \dots, p$ (given that the number of equations equals the rank p). We can write the conditional density defined in this way as

$$f_{\mathbf{X}}(\mathbf{x} | \mathbf{M} = \mathbf{0}) = \left(\frac{1}{\sqrt{2\pi}}\right)^m \exp\left(-\frac{1}{2}\|\mathbf{x} - \mathbf{x}_0\|^2\right), \quad \mathbf{x} \in \{\mathbf{x} \in \mathbb{R}^n | \mathbf{A}\mathbf{x} + \mathbf{b} = \mathbf{0}\} \quad (4.5.6)$$

where $\mathbf{M} = \mathbf{A}\mathbf{x} + \mathbf{b}$ and \mathbf{x}_0 is the point in the set $H_1 \cap \dots \cap H_p$ that is closest to the origin, that is, the point $\mathbf{x}_0 = \hat{E}[\mathbf{X} | \mathbf{M} = \mathbf{0}]$ given by (4.4.7). For reasons of symmetry it is clear that \mathbf{x}_0 also is the conditional mean value vector $E[\mathbf{X} | \mathbf{M} = \mathbf{0}]$. Since \mathbf{x}_0 is a vector of arbitrary length it follows that $\hat{E}[\mathbf{X} | \mathbf{M}] = E[\mathbf{X} | \mathbf{M}]$ generally. This proves the statement in Remark 4.2.

The conditional covariance matrix corresponding to the conditional density (4.5.6) is determined by

$$\begin{aligned} \text{Cov}[\mathbf{X}, \mathbf{X}^T | \mathbf{M} = \mathbf{0}] &= \left(\frac{1}{\sqrt{2\pi}}\right)^m \int_{\mathbf{A}(\mathbf{x} - \mathbf{x}_0) = \mathbf{0}} (\mathbf{x} - \mathbf{x}_0)(\mathbf{x} - \mathbf{x}_0)^T \exp\left(-\frac{1}{2}\|\mathbf{x} - \mathbf{x}_0\|^2\right) d\mathbf{x} = \\ &\left(\frac{1}{\sqrt{2\pi}}\right)^m \int_{\mathbf{A}(\mathbf{z} - \mathbf{z}_0) = \mathbf{0}} (\mathbf{z} - \mathbf{z}_0)(\mathbf{z} - \mathbf{z}_0)^T \exp\left(-\frac{1}{2}\|\mathbf{z} - \mathbf{z}_0\|^2\right) d\mathbf{z} = \text{Cov}[\mathbf{X}, \mathbf{X}^T | \mathbf{M} = \mathbf{m}] \end{aligned} \quad (4.5.7)$$

in which we have substituted $\mathbf{x} - \mathbf{x}_0 = \mathbf{z} - \mathbf{z}_0$ with $\mathbf{z}_0 = \hat{E}[\mathbf{X} | \mathbf{M} = \mathbf{m}]$ where \mathbf{m} is an arbitrary vector. Thus the conditional covariance matrix of \mathbf{X} given \mathbf{M} is independent of the value \mathbf{m} of \mathbf{M} . Note that this does not imply that $\text{Cov}[\mathbf{X}, \mathbf{X}^T | \mathbf{M}]$ is identical with $\text{Cov}[\mathbf{X}, \mathbf{X}^T]$. Using (4.3.21) on the residual covariance matrix gives

$$\begin{aligned} &\text{Cov}[(\mathbf{X} - E[\mathbf{X} | \mathbf{M}]), (\mathbf{X} - E[\mathbf{X} | \mathbf{M}])^T] = \\ &\text{Cov}[E[(\mathbf{X} - E[\mathbf{X} | \mathbf{M}]) | \mathbf{M}], E[(\mathbf{X} - E[\mathbf{X} | \mathbf{M}]) | \mathbf{M}]^T] + \\ &E\left[\text{Cov}[(\mathbf{X} - E[\mathbf{X} | \mathbf{M}]), (\mathbf{X} - E[\mathbf{X} | \mathbf{M}])^T | \mathbf{M}]\right] = \\ &E[\text{Cov}[\mathbf{X}, \mathbf{X}^T | \mathbf{M}]] = \text{Cov}[\mathbf{X}, \mathbf{X}^T | \mathbf{M}] \end{aligned} \quad (4.5.8)$$

This is an important result valid for the normal distribution: *the conditional covariance matrix and the residual covariance matrix are identical*. A proof of (4.4.14) is hereafter obtained by letting \mathbf{X} have standard normal distribution.

Exercise 4.2 Let \mathbf{X} be n -dimensional standard-normal and define the random vector $\mathbf{Y} = \mathbf{TX} + \boldsymbol{\mu}$, where \mathbf{T} and $\boldsymbol{\mu}$ are arbitrary constant matrices of type (m, n) and $(m, 1)$, respectively. Then \mathbf{Y} is said to be m -dimensional normal with mean value vector $\boldsymbol{\mu}$ and covariance matrix \mathbf{TT}^T . Let $\mathbf{M} = \mathbf{AY} + \mathbf{b}$, where \mathbf{A} and \mathbf{b} are arbitrary allowable matrices with \mathbf{A} having full rank.

Show that $\hat{E}[\mathbf{Y}|\mathbf{M}] = E[\mathbf{Y}|\mathbf{M}]$ and that $\text{Cov}[\mathbf{Y}, \mathbf{Y}^T | \mathbf{M}]$ is identical with the residual covariance matrix $\text{Cov}[\mathbf{Y} - \hat{E}[\mathbf{Y}|\mathbf{M}], (\mathbf{Y} - \hat{E}[\mathbf{Y}|\mathbf{M}])^T]$.

Show that the general expression for the m -dimensional normal density is

$$f_{\mathbf{X}}(\mathbf{x}) = \frac{1}{\sqrt{(2\pi)^m \det(\text{Cov}[\mathbf{X}, \mathbf{X}^T])}} \exp\left(-\frac{1}{2}(\mathbf{x} - \boldsymbol{\mu})^T \text{Cov}[\mathbf{X}, \mathbf{X}^T]^{-1}(\mathbf{x} - \boldsymbol{\mu})\right), \quad \mathbf{x} \in \mathbb{R}^m \quad (4.5.9)$$

□

Exercise 4.3 Let (X, Y) be two-dimensional normal and let $E[Y|X] = \rho X$, $\text{Var}[Y|X] = 1 - \rho^2$, $E[X] = 0$, and $\text{Var}[X] = 1$.

Show that (X, Y) has the density

$$\varphi_2(x, y; \rho) = \frac{1}{2\pi\sqrt{1-\rho^2}} \exp\left(-\frac{x^2 - 2\rho xy + y^2}{2(1-\rho^2)}\right) \quad (4.5.10)$$

and show that

$$\frac{\partial^2 \varphi_2(x, y; \rho)}{\partial x \partial y} \equiv \frac{\partial \varphi_2(x, y; \rho)}{\partial \rho} \quad (4.5.11)$$

Use this to prove the formula

$$\Phi_2(x, y; \rho) = \Phi(x)\Phi(y) + \int_0^\rho \varphi_2(x, y; t) dt \quad (4.5.12)$$

where $\Phi_2(x, y; \rho)$ is the distribution function corresponding to the density $\varphi_2(x, y; \rho)$ of the two-dimensional normal distribution with mean values $(0, 0)$, variances $(1, 1)$ and correlation coefficient ρ . □

Bibliography

[4.1] Ove Ditlevsen (1981) *Uncertainty Modeling*. McGraw-Hill, New York

This page is intentionally left blank.

Chapter 5

GEOMETRIC RELIABILITY INDEX

5.1 Nonlinear safety margin. Linearization problem

Only rarely limit states for structures are formulated such that they are linear in all input variables x_1, \dots, x_n . In the early attempts to evaluate the safety by use of probabilistic concepts it was an obvious idea to define a safety margin M by use of the limit-state function $g(x_1, \dots, x_n)$. To be a safety margin, M must be a random variable that satisfies the condition that $M > 0$ at the internal points of the safe set, $M = 0$ at the limit state, and $M < 0$ at the internal points of the failure set. This condition is satisfied by the limit-state function when X is substituted for x . Thus the safety margin

$$M = g(X_1, \dots, X_n) \quad (5.1.1)$$

was defined and it was attempted to compute a reliability index by use of the formula

$$\beta = \frac{E[M]}{D[M]} \quad (5.1.2)$$

It is shown in Chapter 4 that this index is defined uniquely if the limit-state surface is a hyperplane and only linear safety margins are used for the description of the limit state. However, with β defined by (5.1.1) and (5.1.2) we are in a situation where β cannot be determined solely by use of the second-moment representation for \mathbf{X} . Distributional assumptions are needed. To circumvent this problem in a formulation that aims to be based solely on information of first and second moments the limit-state function $g(x_1, \dots, x_n)$ was replaced by a linear approximation to g .

As done in the usual error analysis that is a well established tool in the field of measurement technique (experimental physics, land surveying etc.) the function $g(\mathbf{X})$ is replaced by its first order Taylor expansion at the mean value $\boldsymbol{\mu} = E[\mathbf{X}]$:

$$g(\mathbf{X}) \stackrel{\mu}{=} M_{\boldsymbol{\mu}} = g(\boldsymbol{\mu}) + \sum_{i=1}^n g_{,i}(\boldsymbol{\mu})(X_i - E[X_i]) \quad (5.1.3)$$

($\stackrel{\mu}{=}$ means "equal to" up to the first order terms by Taylor expansion at the point $\boldsymbol{\mu}$). The right side of (5.1.3) will be denoted as the *linearly associated to $g(\mathbf{X})$ at $\boldsymbol{\mu}$* and it has the form as a linear

safety margin. The corresponding simple reliability index $\beta_{\boldsymbol{\mu}}$ can then be calculated solely by the use of the second-moment representation for \mathbf{X} . In the early developments of the applications of probabilistic reasoning in structural reliability it was assumed that

$$\beta_{\boldsymbol{\mu}} = \frac{g(\boldsymbol{\mu})}{\sqrt{\sum_{i=1}^n \sum_{j=1}^n g_{,i}(\boldsymbol{\mu}) g_{,j}(\boldsymbol{\mu}) \text{Cov}[X_i, X_j]}} \quad (5.1.4)$$

is a reasonable approximation to β . However, it is easy to see that it is a serious problem that the limit-state function g is arbitrary except for the requirement that the limit state should be defined as the set

$$\{\mathbf{X} \in \mathbb{R}^n \mid g(\mathbf{X}) = 0\} \quad (5.1.5)$$

For example, this set is identical to the set

$$\{\mathbf{X} \in \mathbb{R}^n \mid g(\mathbf{X})^3 = 0\} \quad (5.1.6)$$

and $g(\mathbf{X})^3$ satisfies the conditions for being a safety margin. By use of the limit-state function $h(\mathbf{X}) = g(\mathbf{X})^3$ in stead of $g(\mathbf{X})$ the right hand side of (5.1.4) becomes

$$\frac{g(\boldsymbol{\mu})^3}{\sqrt{\sum_{i=1}^n \sum_{j=1}^n 3g(\boldsymbol{\mu})^2 g_{,i}(\boldsymbol{\mu}) 3g(\boldsymbol{\mu})^2 g_{,j}(\boldsymbol{\mu}) \text{Cov}[X_i, X_j]}} = \frac{1}{3} \beta_{\boldsymbol{\mu}} \quad (5.1.7)$$

where $\beta_{\boldsymbol{\mu}}$ is the simple reliability index (5.1.4). Thus we get completely different values of β as defined by (5.1.2) dependent of the arbitrary choice of the limit-state function.

This lack of so-called formulation invariance of the reliability index definition (5.1.2) is not only related to the error of linearization. This follows from the fact that the linearization error become almost vanishing when the standard deviations of X_1, \dots, X_n become small. The factor of 1/3 from (5.1.4) to (5.1.7) exists independent of this.

Formulation invariance is achieved, naturally, if (5.1.2) is rejected and the probability $P(M > 0)$ is used as a measure of reliability. However, this step would imply that the idea of formulating a simple reliability analysis model that solely works with second-moment representations must be abandoned. This turns out not to be necessary. As it is seen in many other cases of concept extensions associated to mathematical models, the problem is caused by an inconvenient choice of property for generalization. The simple reliability index is in a natural way defined by the formula (5.1.2). However, a formulation-invariant extension of (5.1.2) does not exist. On the other hand, the simple reliability index β has the formulation-invariant property that β is the distance from the origin to the limit state surface in the normalized space. Therefore this property can be taken as the basis for extension to limit-state surfaces that are not plane.

Example 5.1 The early application of the simple reliability index were based on a splitting of the limit-state function in two terms denoted as the resistance R and the load effect S , respectively. The considered reliability indices were defined as, see Example 2.4,

$$\beta_C = \frac{\mu_R - \mu_S}{\sqrt{\sigma_R^2 + \sigma_S^2}} \quad (5.1.8)$$

or as, see Exercise 2.1,

$$\beta_{ER} = \frac{\mu_{\log R} - \mu_{\log S}}{\sqrt{\sigma_{\log R}^2 + \sigma_{\log S}^2}} \approx \frac{\log(\mu_R/\mu_S)}{\sqrt{V_R^2 + V_S^2}} \quad (5.1.9)$$

For the early applications of these reliability indices the lack of formulation invariance was not crucial. The applications were essentially about comparisons within a narrow structural domain of variation. For example it could be about the calibration of a code concerning the application of a given carrying-capacity formula. A design formalism is sought such that the reliability index varies as little as possible over the practical domain of variation for the formula. Thus the reliability index was used with the purpose of ensuring local uniform reliability assuming that the failure probability is some unknown function solely of the reliability index. The more ambitious goal of being able to justify comparisons of global extension has motivated the development described in the following.

□

5.2 The geometric reliability index

Let the limit-state function in the space of input variables x_1, \dots, x_n be given by the equation

$$g(x_1, \dots, x_n) = 0 \quad (5.2.1)$$

and let the input variables be random variables collected in the vector \mathbf{X} with the second moment representation $E[\mathbf{X}]$ and $\text{Cov}[\mathbf{X}, \mathbf{X}^T]$. To generalize the simple reliability index the normalized random variables Y_1, \dots, Y_n are introduced by a suitable one to one inhomogeneous linear mapping $\mathbf{X} = L(\mathbf{Y})$, $\mathbf{Y} = L^{-1}(\mathbf{X})$. For example, this linear mapping may be composed of a parallel shift and a rotation of the coordinate system followed by an axis parallel affinity, see Remark 5.1. The corresponding space of points \mathbf{y} is then defined by the transformation

$$\mathbf{x} = L(\mathbf{y}), \quad \mathbf{y} = L^{-1}(\mathbf{x}) \quad (5.2.2)$$

By this the limit-state equation (5.2.1) is mapped into the equation

$$h(y_1, \dots, y_n) = 0 \quad (5.2.3)$$

where the function h is defined by

$$h(\mathbf{y}) = g[L(\mathbf{y})] \quad (5.2.4)$$

Equation (5.2.3) defines the limit-state surface in the normalized space. The mean value of \mathbf{Y} is at the origin and the projection of \mathbf{Y} on an arbitrary straight line through the origin is a random variable with the standard deviation 1. The *geometric reliability index* β is then defined as the distance in the normalized space from the origin to the limit state surface, that is,

$$\beta = \min\{\sqrt{\mathbf{y}^T \mathbf{y}} \mid h(\mathbf{y}) = 0\} \quad (5.2.5)$$

where the minimum of the distance $\sqrt{\mathbf{y}^T \mathbf{y}}$ is obtained for \mathbf{y} varying over the entire limit state surface $h(\mathbf{y}) = 0$. [Usually the limit-state surface is a closed but not necessarily bounded set in \mathbb{R}^n . Therefore the operation “min” is written in stead of the more general “inf” (infimum = largest lower bound)].

A point \mathbf{y} on the limit state surface with $\beta = \sqrt{\mathbf{y}^T \mathbf{y}}$ is called a *globally most central limit-state point*. There may exist several such globally most central limit-state points. In particular the limit-state surface may have an infinity of points common with a sphere surface with center at the origin and radius β .

A point \mathbf{z} with the property that there is an open neighborhood $N(\mathbf{z})$ of \mathbf{z} such that

$$\sqrt{\mathbf{z}^T \mathbf{z}} = \min\{\sqrt{\mathbf{y}^T \mathbf{y}} \mid \mathbf{y} \in N(\mathbf{z}), h(\mathbf{y}) = 0\} \quad (5.2.6)$$

is called a *locally most central limit-state point*, see Figure 5.1. Obviously the globally most central limit-state points should be sought among the locally most central limit-state points.

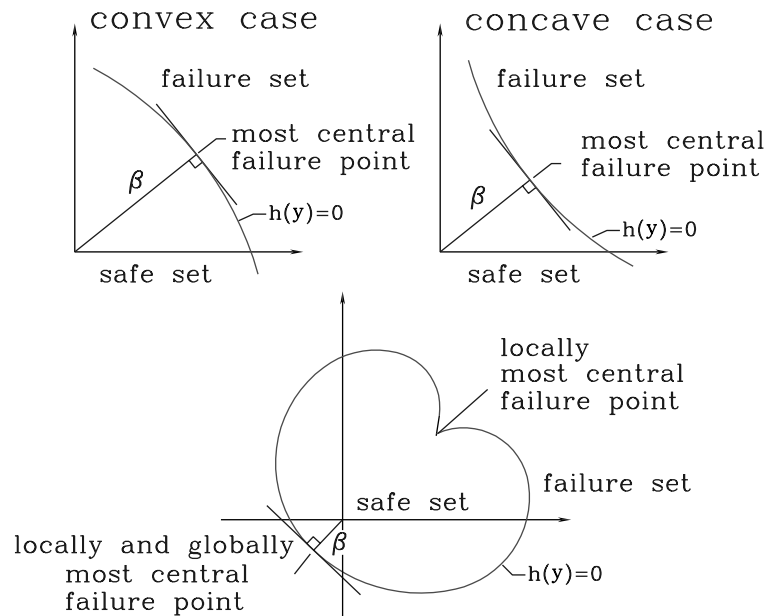

Figure 5.1: Locally and globally most central limit-state point.

Remark 5.1 The linear transformation $\mathbf{X} = L(\mathbf{Y})$ is defined by a matrix \mathbf{T} and a vector $\boldsymbol{\mu}$ as

$$L(\mathbf{Y}) = \mathbf{T}\mathbf{Y} + \boldsymbol{\mu} \quad (5.2.7)$$

where

$$\boldsymbol{\mu} = E[\mathbf{X}] \quad (5.2.8)$$

and \mathbf{T} satisfies the condition

$$\text{Cov}[\mathbf{X}, \mathbf{X}^T] = \mathbf{T}\mathbf{T}^T \quad (5.2.9)$$

The splitting of the covariance matrix for \mathbf{X} in the product of a square matrix \mathbf{T} and its transposed matrix \mathbf{T}^T is not unique. If the covariance matrix is regular it is often computationally the simplest to determine \mathbf{T} as a lower-triangular matrix (that is, all the elements above the diagonal are zero) by Cholesky factorization method, described in several textbooks on matrix algebra.

Another possibility is to use diagonalization of the covariance matrix. In all cases there exist an orthogonal matrix \mathbf{V} and a diagonal matrix $\mathbf{\Lambda}$ such that

$$\text{Cov}[\mathbf{X}, \mathbf{X}^T] = \mathbf{V}\mathbf{\Lambda}\mathbf{V}^T \quad (5.2.10)$$

where the elements of the diagonal of $\mathbf{\Lambda} = [\lambda_1 \dots \lambda_n]$ are the eigenvalues (taken in arbitrary order) of the covariance matrix while the columns in \mathbf{V} are the corresponding eigenvectors taken in the succession of eigenvalues. A matrix \mathbf{T} that satisfies (5.2.9) is then

$$\mathbf{T} = \mathbf{V}\mathbf{\Lambda}^{1/2} \quad (5.2.11)$$

where $\mathbf{\Lambda}^{1/2} = [\sqrt{\lambda_1} \dots \sqrt{\lambda_n}]$. Since covariance matrices solely have real eigenvalues that are non-negative (which follows from the fact that the expectation functional property $X \geq 0 \Rightarrow E[X] \geq 0$ implies that $\text{Var}[X] \geq 0$) the matrix \mathbf{T} becomes a matrix of real numbers. \square

Those points in the \mathbf{x} -space that correspond to the locally or globally most central limit-state points in the normalized space through the transformation $\mathbf{x} = L(\mathbf{y})$ are denoted as the locally or globally most central limit-state points in the \mathbf{x} -space. With reference to the particular metric that is generated in the \mathbf{x} -space by the usual Euklidian metric in the normalized space by the invariance

$$\begin{aligned} \|\mathbf{y}\|_{\mathbf{y}} &= \sqrt{\mathbf{y}^T \mathbf{y}} = \sqrt{(\mathbf{x} - \boldsymbol{\mu})^T (\mathbf{T}^{-1})^T \mathbf{T}^{-1} (\mathbf{x} - \boldsymbol{\mu})} \\ &= \sqrt{(\mathbf{x} - \boldsymbol{\mu})^T \text{Cov}[\mathbf{X}, \mathbf{X}^T]^{-1} (\mathbf{x} - \boldsymbol{\mu})} = \|\mathbf{x} - \boldsymbol{\mu}\|_{\mathbf{x}} \end{aligned} \quad (5.2.12)$$

the globally most central limit-state point is the point on the limit-state surface which is closest to the mean-value point $\boldsymbol{\mu} = E[\mathbf{X}]$.

5.3 Determination of a locally most central limit-state point by use of linear regression

Let us assume that the limit-state surface \mathcal{G} with the equation (5.2.1) is a differentiable surface with a continuous vector of partial derivatives

$$\text{grad } g = (g_{,1}(\mathbf{x}), \dots, g_{,n}(\mathbf{x})), \quad \mathbf{x} \in \mathcal{G} \quad (5.3.1)$$

that at no point of \mathcal{G} is the zero vector. The vector (5.3.1) is orthogonal to the tangent hyperplane to \mathcal{G} at the point \mathbf{x} .

Assume that $\mathbf{x}_0 \in \mathcal{G}$ is a locally most central point on \mathcal{G} . The tangent hyperplane to \mathcal{G} at \mathbf{x}_0 has the equation

$$\{g_{,i}(\mathbf{x}_0)\}^T (\mathbf{x} - \mathbf{x}_0) = 0 \quad (5.3.2)$$

where $\{g_{,i}(\mathbf{x}_0)\}$ is a short notation for the column matrix that corresponds to the vector (5.3.1) of partial derivatives. Naturally, \mathbf{x}_0 is also a locally most central point on the tangent hyperplane defined by (5.3.2) (the only such point on the hyperplane, of course), see Figure 5.2. Thus it follows from (4.4.4) that

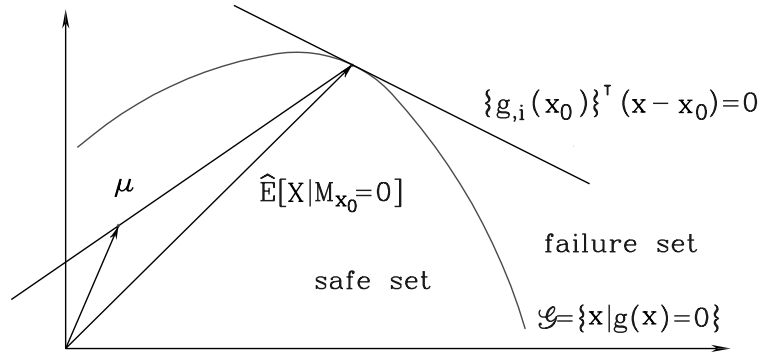

Figure 5.2: Characterization of a locally most central limit-state point in terms of the linear regression $\hat{E}[\mathbf{X} | M_{\mathbf{x}_0} = 0]$.

$$\mathbf{x}_0 = \hat{E}[\mathbf{X} | M_{\mathbf{x}_0} = 0] \quad (5.3.3)$$

in which

$$M_{\mathbf{x}_0} = \{g_{,i}(\mathbf{x}_0)\}^T (\mathbf{X} - \mathbf{x}_0) \quad (5.3.4)$$

is the linear safety margin defined by (5.3.2). $M_{\mathbf{x}_0}$ is called the *linearly associated safety margin to \mathcal{G} at \mathbf{x}_0* . Thus we have the following:

Theorem 5.1 *The point \mathbf{x} is a locally most central point on the limit-state surface \mathcal{G} only if*

$$\mathbf{x} = \hat{E}[\mathbf{X} | M_{\mathbf{x}} = 0] \quad (5.3.5)$$

where $M_{\mathbf{x}}$ is the linearly associated safety margin to \mathcal{G} at \mathbf{x} . Then the corresponding local geometric reliability index is

$$\beta_{\mathbf{x}} = \frac{E[M_{\mathbf{x}}]}{D[M_{\mathbf{x}}]} \quad (5.3.6)$$

In Theorem 5.1 we have introduced the concept of local geometric reliability index. The (global) geometric reliability index is the smallest of the local reliability indices.

The condition (5.3.5) directly points at an iteration principle for the determination of a locally most central point on \mathcal{G} : Let \mathbf{x}_1 be an arbitrary point on \mathcal{G} or reasonably close to \mathcal{G} . Calculate

$$\mathbf{x}_2 = \hat{E}[\mathbf{X} | M_{\mathbf{x}_1} = 0] \quad (5.3.7)$$

where

$$M_{\mathbf{x}_1} = g(\mathbf{x}_1) + \{g_{,i}(\mathbf{x}_1)\}^T (\mathbf{X} - \mathbf{x}_1) \quad (5.3.8)$$

If $\mathbf{x}_2 = \mathbf{x}_1$, then \mathbf{x}_1 is possibly a locally most central point on \mathcal{G} . Otherwise replace \mathbf{x}_1 with \mathbf{x}_2 and start from scratch with (5.3.7). In this way a sequence $\mathbf{x}_1, \mathbf{x}_2, \dots, \mathbf{x}_m, \dots$ of points is constructed. If the sequence is convergent with the limit \mathbf{x} , then \mathbf{x} is possibly a locally most central point on \mathcal{G} . To prove this we need only to note that the function

$$\psi(\mathbf{x}) = \hat{E}[\mathbf{X} | M_{\mathbf{x}} = 0] \quad (5.3.9)$$

is continuous. Then $\{\mathbf{x}_m\} \rightarrow \mathbf{x}$ implies $\{\psi(\mathbf{x}_m)\} \rightarrow \psi(\mathbf{x})$ and since the two sequences are identical except for the first element of $\{\mathbf{x}_m\}$ we have that $\mathbf{x} = \psi(\mathbf{x})$.

After this it is easy to see that $g(\mathbf{x}) = 0$, and thus $\mathbf{x} \in \mathcal{G}$. In fact, with the notation

$$\nabla g = \{g_{,i}(\mathbf{x})\} \quad (\text{column matrix}) \quad (5.3.10)$$

we have that the equation $\mathbf{x} = \psi(\mathbf{x})$ can be written as

$$\mathbf{x} - E[\mathbf{X}] = -\frac{\text{Cov}[\mathbf{X}, \mathbf{X}^T] \nabla g}{\nabla g^T \text{Cov}[\mathbf{X}, \mathbf{X}^T] \nabla g} [g(\mathbf{x}) + \nabla g^T (E[\mathbf{X}] - \mathbf{x})] \quad (5.3.11)$$

By scalar multiplication by ∇g^T it then follows that $g(\mathbf{x}) = 0$.

It is not ensured that the constructed sequence is convergent. However, under the given assumptions the equation (5.3.5) always possesses one or more solutions. Several different numerical methods can be applied for the determination of these solutions. The interpretation of the solutions as local solutions to an optimization problem as defined by (5.2.5) or (5.2.6) with (5.2.12) substituted also points at the use of optimization algorithms.

Example 5.2 Assume that the limit-state curve is a parabola with the equation

$$g(x, y) = 1 - x^2 - y = 0 \quad (5.3.12)$$

and that $E[X] = E[Y] = 0.5$, $D[X] = D[Y] = 1$, and $\text{Cov}[X, Y] = 0.5$, see Fig. 5.3. We will apply the iteration method based on Theorem 5.1 to determine the geometric reliability index of (5.3.12). We have

$$\frac{\partial g(x, y)}{\partial x} = -2x, \quad \frac{\partial g(x, y)}{\partial y} = -1 \quad (5.3.13)$$

so that

$$M_{(x,y)} = -2x(X - x) - (Y - y) + 1 - x^2 - y \quad (5.3.14)$$

To calculate the linear regression of (X, Y) on $M_{(x,y)}$ we need, see (4.4.3),

$$E[M_{(x,y)}] = -2x(E[X] - x) - (E[Y] - y) + 1 - x^2 - y = x^2 - x + 0.5 \quad (5.3.15)$$

$$\text{Var}[M_{(x,y)}] = 4x^2 \text{Var}[X] + \text{Var}[Y] + 4x \text{Cov}[X, Y] = 4x^2 + 2x + 1 \quad (5.3.16)$$

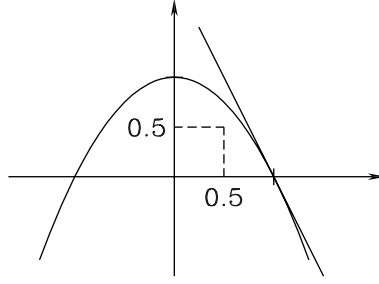

Figure 5.3: Parabolic limit-state curve given by (5.3.12).

and

$$\text{Cov} \left[\begin{bmatrix} X \\ Y \end{bmatrix}, M_{(x,y)} \right] = -2x \text{Cov} \left[\begin{bmatrix} X \\ Y \end{bmatrix}, X \right] - \text{Cov} \left[\begin{bmatrix} X \\ Y \end{bmatrix}, Y \right] = \begin{bmatrix} -2x & -0.5 \\ -x & -1 \end{bmatrix} \quad (5.3.17)$$

Thus

$$\hat{E} \left[\begin{bmatrix} X \\ Y \end{bmatrix} \mid M_{(x,y)} = 0 \right] = \begin{bmatrix} 0.5 \\ 0.5 \end{bmatrix} + \begin{bmatrix} 2x+0.5 \\ x+1 \end{bmatrix} \frac{x^2 - x + 0.5}{4x^2 + 2x + 1} \quad (5.3.18)$$

and

$$\beta_{(x,y)} = \frac{x^2 - x + 0.5}{\sqrt{4x^2 + 2x + 1}} \quad (5.3.19)$$

The right sides are seen to depend solely on x . Therefore it is sufficient to make iterations in the first coordinate:

$$\hat{E}[X \mid M_{(x,y)} = 0] = 0.5 + (2x + 0.5) \frac{x^2 - x + 0.5}{4x^2 + 2x + 1} \quad (5.3.20)$$

Take $x_1 = 0.5$ as starting point for the iteration. In the first step we then have (with $\beta_x = \beta_{(x,y)}$)

$$\beta_{0.5} = \frac{1}{4\sqrt{3}} = 0.1443, \quad x_2 = 0.5 + 1.5 \frac{0.25}{3} = 0.625 \quad (5.3.21)$$

Second step gives $\beta_{0.625} = 0.1360$, $x_3 = 0.6219$. Third step gives $\beta_{0.6219} = 0.1360$, $x_4 = 0.6218$. \square

We conclude this section by the case where the limit-state surface \mathcal{G} is not differentiable everywhere, but where it is composed of p differentiable surfaces

$$\mathcal{G}_i = \{\mathbf{x} \in \mathbb{R}^n \mid g_i(\mathbf{x}) = 0\}, \quad i = 1, \dots, p \quad (5.3.22)$$

Each of the functions g_1, \dots, g_p satisfies the conditions put on g previously. Then it is possible, but not necessarily true, that the intersection

$$\mathcal{K} = \mathcal{G}_1 \cap \dots \cap \mathcal{G}_p \quad (5.3.23)$$

contains a locally most central point for the composed limit-state surface \mathcal{G} . Relative to \mathcal{K} itself there exists always a locally most central point in \mathcal{K} . It is the point of \mathcal{K} that by the mapping into the normalized space is closest to the origin. With support in the formula (4.4.7), Theorem 5.1 can directly be generalized to

Theorem 5.2 *The point \mathbf{x} is a locally most central point of $\mathcal{K} = \mathcal{G}_1 \cap \dots \cap \mathcal{G}_p$ only if*

$$\mathbf{x} = \hat{E}[\mathbf{X} | M_{\mathbf{x}}^{(1)} = 0, \dots, M_{\mathbf{x}}^{(p)} = 0] \quad (5.3.24)$$

where $M_{\mathbf{x}}^{(i)}$ is the linearly associated safety margin to \mathcal{G}_i at the point \mathbf{x} , $i = 1, \dots, p$.

The iteration principle for the solution of equation (4.4.5) is directly generalized for the solution of equation (5.3.24).

Example 5.3 We will calculate the projection of the origin on the straight line defined by the equations

$$\begin{aligned} x + 2y + 3z &= 3 \\ 3x + y + 4z &= 2 \end{aligned} \quad (5.3.25)$$

by use of Theorem 5.2. Let \mathbf{X} be a random vector with $E[\mathbf{X}] = \mathbf{0}$ and $\text{Cov}[\mathbf{X}, \mathbf{X}^T] = \mathbf{I}$ (the unit matrix) and define the vector

$$\mathbf{M} = \begin{bmatrix} 3 \\ 2 \end{bmatrix} - \begin{bmatrix} 1 & 2 & 3 \\ 3 & 1 & 4 \end{bmatrix} \mathbf{X} \quad (5.3.26)$$

It has the covariance matrix

$$\text{Cov}[\mathbf{M}, \mathbf{M}^T] = \begin{bmatrix} 1 & 2 & 3 \\ 3 & 1 & 4 \end{bmatrix} \begin{bmatrix} 1 & 3 \\ 2 & 1 \\ 3 & 4 \end{bmatrix} = \begin{bmatrix} 14 & 17 \\ 17 & 26 \end{bmatrix} \quad (5.3.27)$$

Moreover we have

$$E[\mathbf{M}] = \begin{bmatrix} 3 \\ 2 \end{bmatrix} \quad \text{and} \quad \text{Cov}[\mathbf{X}, \mathbf{M}^T] = - \begin{bmatrix} 1 & 3 \\ 2 & 1 \\ 3 & 4 \end{bmatrix} \quad (5.3.28)$$

such that the linear regression of \mathbf{X} on \mathbf{M} becomes

$$\hat{E}[\mathbf{X} | \mathbf{M}] = - \begin{bmatrix} 1 & 3 \\ 2 & 1 \\ 3 & 4 \end{bmatrix} \frac{1}{75} \begin{bmatrix} 26 & -17 \\ -17 & 14 \end{bmatrix} \left(\mathbf{M} - \begin{bmatrix} 3 \\ 2 \end{bmatrix} \right) \quad (5.3.29)$$

or

$$\hat{E}[\mathbf{X} | \mathbf{M} = \mathbf{0}] = \frac{1}{15} \begin{bmatrix} -5 \\ 13 \\ 8 \end{bmatrix} \quad (5.3.30)$$

□

5.4 Historical and bibliographical notes

The use of consistent calculations with mean values and standard deviations for strengths, loads and geometric quantities for the determination of the safety factors to be used together with simple carrying capacity formulas was suggested as early as in the 1920s by M. Mayer [5.9]. The basis was directly available in the tool box of the civil engineers of those days where the theory of errors was taught in connection with the topic of land surveying. However, the much larger complexity of the error problem when considering a structure kept the development back for several decades. This was not the least due to the many relevant but seemingly incommensurable sources of uncertainty that influence the structural safety problem. Attempts to reconsider the reliability index idea was not made before about 1960. It was suggested by E. Basler [5.1] but the idea was not appreciated before acceptance of the classical Bayesian interpretation of the probability concept which had long been rejected by the frequentists.

The Bayesian interpretation allows introduction of random judgemental variables that do not show fluctuations in the physical sense but still are considered to carry information about uncertainty. Such random variables make it possible to join contributions from uncertainty sources of completely different types in a probabilistic model without causing philosophical problems. This line of thought penetrated into the civil engineering education at several leading American engineering schools. The structural safety problem was an obvious domain of application for this philosophy and the reliability index was reborn with convincing strength. Among the pioneers should be mentioned C.A. Cornell [5.2] (β_C in Example 5.1), L. Esteva and E. Rosenblueth [5.5] (β_{ER} in Example 5.1), C. Turkstra [5.10]. The development was strongly promoted by the current code revision work both in North America and in Europe, and particularly so in the Scandinavian cooperation. This code work revealed that there was an urgent need for establishing a rational basis for the determination of the safety factors that should be specified in the codes.

The formulation-invariance problem was pointed out in 1972 by O. Ditlevsen [5.3] and by N. Lind who in 1974 together with A.M. Hasofer suggested the geometric reliability index [5.7] as a formulation invariant and operational reliability measure. The geometric property of the simple reliability index was demonstrated much earlier in an example in a larger paper on structural reliability by A.M. Freudenthal in 1956 [5.6]. Freudenthal's reliability considerations were based on complete probability models that at the time of the paper were difficult to apply due to computational problems and due to the narrow interpretation of the concept of probability. In this connection it should be mentioned that from the end of the 1940s and the beginning of the 1950s there are several works on fully probability based reliability considerations. Among these there is a particularly interesting dissertation by A.J. Johnson [5.8].

The particular use of linear regression of \mathbf{X} on M for determination of the most central limit-state point as well as the geometric reliability index is suggested by O. Ditlevsen and used for example in [5.4] that gives the first version of the model given in Section 3.4 for representation of model uncertainty.

Bibliography

- [5.1] E. Basler (1961) Untersuchungen über der Sicherheitsbegriff von Bauwerken. *Schweizer Archiv*, **27**.
- [5.2] C.A. Cornell (1969) A Probability-based structural code. *Journal of the ACI*, **66**, 974-985.
- [5.3] O. Ditlevsen (1973) *Structural Reliability and the Invariance Problem*. Report No. 22, University of Waterloo, Solid Mechanics Division, Waterloo, Canada.
- [5.4] O. Ditlevsen (1982) Model Uncertainty in Structural Reliability. *Structural Safety*, **1**, 73-86.
- [5.5] L. Esteva and E. Rosenblueth (1972) Reliability Basis for Some Mexican Codes. *ACI publication SP-31-1*, American Concrete Institute, Detroit, Michigan.
- [5.6] A.M. Freudenthal (1956) Safety and the Probability of Structural Failure. *Trans. ASCE*, **121**.
- [5.7] A.M. Hasofer and N.C. Lind (1974) An exact and invariant first-order reliability format. *Journal of Eng. Mech.*, ASCE, **100**, 111-121.
- [5.8] A.I. Johnson (1953) *Strength, Safety and Economical Dimensions of Structures*. Statens Kommitté för Byggnadsforskning. Meddelanden nr. 22. Stockholm.
- [5.9] M. Mayer (1926) *Die Sicherheit der Bauwerke*. Springer Verlag, Berlin.
- [5.10] C. Turkstra (1970) *Applications of Bayesian Decision Theory*. Study No. 3: Structural Reliability and Codified Design. University of Waterloo, Solid Mechanics Division, Waterloo, Canada.

This page is intentionally left blank.

Chapter 6

GENERALIZED RELIABILITY INDEX

6.1 Shortcomings of the geometric reliability index

From a mathematical point of view the geometric reliability index is a crudely structured extension of the simple reliability index from the set of plane limit-state surfaces to the set of general limit-state surfaces. It is crude because it does not distinguish between limit-state surfaces that are tangential to each other at the common point closest to the origin in the normalized space. Thus these limit-state surfaces are all assigned the same reliability. This raises the question of whether such a reliability index in general has a sufficient degree of resolution to satisfy engineering goals.

In spite of this question the geometric reliability index is useful because a limit-state surface for a realistic structure is often almost plane in the sense that the tangent hyperplane at the most central point only deviates slightly from the limit-state surface within a domain that contains the essential part of the failure probability mass. The simple reliability index of the tangent hyperplane at the most central limit-state point therefore often turns out to be a sufficiently good measure of reliability. The domain of application for the geometric reliability index is thus the limit state surfaces that in the indicated sense are almost plane. The method simply points at a "reliability-equivalent" plane limit state surface whose simple reliability index is used as a reliability measure for the curved but almost plane limit-state surface. The characterization is at this stage very imprecise. A quantitative evaluation requires an extension of the reliability index definition which takes account of the deviation from plainness of the limit-state surface. In the following we will introduce such an extension to a generalized reliability index that solves this problem. The geometric reliability index preserves its practical importance by being a good approximation to the generalized reliability index for "almost plane" limit state surfaces. Besides, it gets an essential importance as a computationally characteristic quantity in connection with the calculation of the generalized reliability index.

We will now look at the requirements that a reliability index should satisfy in order to be reasonable from an engineering point of view. Let a, b, c, \dots be structures with corresponding limit states that can be represented in the normalized space of input variables. Let $\mathcal{S}_a, \mathcal{S}_b, \mathcal{S}_c, \dots$ be the corresponding safe sets. A reasonable requirement to a reliability-analysis model is that it is capable of ordering the structures with respect to reliability. Thus we want to define an ordering relation " $<$ " in the set of structures such that the statement $a < b$ is tantamount to the statement " b

is as least as safe as a with respect to the considered limit states". This ordering relation should naturally be transitive ($a < b \wedge b < c \Rightarrow a < c$) and antisymmetric ($a < b \wedge b < a \Leftrightarrow a \sim b$). The equivalence relation $a \sim b$ is expressed in words by the statement " a and b are equally safe".

A reasonable property is

$$\mathcal{S}_a \subset \mathcal{S}_b \Rightarrow a < b \quad (6.1.1)$$

Under the explicit assumption that no other information is available than the second-moment representation of the input variables, the rotation symmetry with respect to uncertainty of the normalized space must be accepted. Thus we must accept the more general property:

$$\text{If the safe set } \mathcal{S}_a \text{ by a rotation with respect to the origin can be transformed} \\ \text{into a subset } \mathcal{S}'_a \text{ of } \mathcal{S}_b, \text{ then } a < b \quad (6.1.2)$$

By definition it is so that a scalar reliability measure β is an ordering-preserving mapping from the set of structures into the real numbers. Each structure is here assigned just one safe set. We have

$$a < b \Leftrightarrow \beta(a) \leq \beta(b) \quad (6.1.3)$$

and, in particular,

$$a \sim b \Leftrightarrow \beta(a) = \beta(b) \quad (6.1.4)$$

If the set of structures corresponds solely to the set of plane limit-state surfaces, then the simple reliability index is obviously such a reliability measure. For more general sets of limit-state surfaces we may as in the previous chapter let the geometric reliability index be a reliability measure for which (3) and (4) must be satisfied. By this the ordering relation $<$ is introduced in the corresponding set of structures. Inspection of Fig. 6.1 shows, however, that this definition easily gets in conflict with a reasonable engineering judgment of the reliability. This inconvenience has been called lack of dimension invariance [6.9], a concept that will be explained in the following. The simple reliability index can be interpreted as adjoined to a one-dimensional problem. Only the projection of the input vector on the normal of the limit-state hyperplane has relevance for the reliability. However, if the limit-state surface curves as a cylinder surface, the problem becomes two-dimensional since only the projection on the orthogonal plane to the cylinder surface matters with respect to reliability. Dependent on the curvature properties of the limit-state surface the problem is of dimension between 1 and n inclusive. This is not reflected by a corresponding variation of the geometric reliability index.

Example 6.1 The lack of dimension invariance of the geometric reliability index is clearly illustrated by the probability that the input vector \mathbf{X} gets an outcome inside the circular cylinder with the equation

$$x_1^2 + \dots + x_r^2 = \beta^2, \quad r \in \{1, \dots, n\} \quad (6.1.5)$$

when it is assumed that the vector $\mathbf{X} = (X_1, \dots, X_n)$ has a standardized normal distribution. The mentioned event can be written as

$$X_1^2 + \dots + X_r^2 \leq \beta^2 \quad (6.1.6)$$

where the left side has a χ^2 -distribution with r degrees of freedom. The mean value is r and the variance is $2r$. For large values of r the χ^2 -distribution approaches the normal distribution asymptotically. For large values of r we therefore get

$$F_{X_1^2 + \dots + X_r^2}(\beta^2) \approx \Phi\left(\frac{\beta^2 - r}{\sqrt{2r}}\right) \rightarrow \Phi(-\infty) = 0 \quad \text{as } r \rightarrow \infty \quad (6.1.7)$$

for any β . As the dimension increases, more and more of the probability mass is placed outside the cylinder with the fixed radius β . \square

This example extends far beyond the threshold below which the geometric reliability index is reasonable for practical reliability evaluation. Section 6.4 gives criteria for the judgment of the applicability of the geometric reliability index. Before such criteria can be formulated, it is necessary to construct an extension of the simple reliability index to a generalized dimension-invariant reliability index.

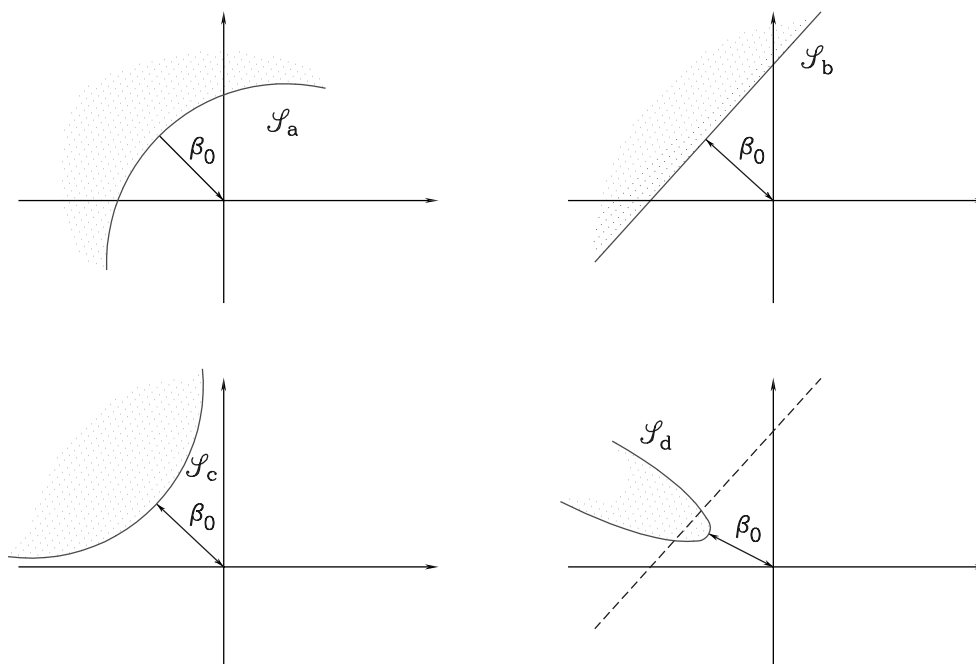

Figure 6.1: Illustration of examples of safe sets ($\mathcal{S}_a, \mathcal{S}_b, \mathcal{S}_c$) for which the geometric reliability index cannot be resolved with respect to reliability. Moreover it is illustrated by an example (\mathcal{S}_d) that there can be a direct inconsistency with engineering judgment.

6.2 Generalized reliability index

We will require that the generalized reliability index β must satisfy the following three basic rules:

1. the generalized reliability index is an extension of the simple reliability index from the set of plane limit-state surfaces to the set of piecewise differentiable limit-state surfaces.
2. The ordering induced by the generalized reliability index has the rotation property (6.1.2).
3. If \mathcal{S}'_a in (6.1.2) is a genuine subset of \mathcal{S}_b , that is, if $\mathcal{S}'_a \subset \mathcal{S}_b \wedge \mathcal{S}'_a \neq \mathcal{S}_b$, then $\beta(a) < \beta(b)$ (which excludes the possibility $a \sim b$).

It is an obvious idea to construct a scalar reliability measure that satisfies the rules 2 and 3 by letting the measure be related to the volume of the safe set. The volume measure cannot be applied directly because it is not bounded for all subsets of \mathbb{R}^n . However, we can apply a weighted volume measure by introducing a suitable weight function $\psi_n : \mathbb{R}^n \rightarrow \mathbb{R}$ which is positive everywhere and which to any suitable regular subset A of \mathbb{R}^n assigns a finite measure determined by the integral of ψ_n over A . Since the relative measure (the ordering property) does not change after multiplication of all measures by a constant, we may without introducing restrictions normalize ψ_n such that all of \mathbb{R}^n is assigned the measure 1. By this normalization ψ_n gets properties as a probability density in \mathbb{R}^n . The rotation symmetry with respect to the origin shows that ψ_n is a function solely of $r^2 = x_1^2 + \dots + x_n^2$.

To satisfy the rule 1 we must define the reliability index by the formula

$$\beta(a) = G\left(\int_{\mathcal{S}_a} \psi_n(\mathbf{x}) \, d\mathbf{x}\right) \quad (6.2.1)$$

where G is a suitable increasing function that maps the interval $[0,1]$ onto \mathbb{R} . If ψ_n has been chosen, the function G is uniquely determined by the rule 1. In principle any rotation symmetric probability density ψ_n can be used as the basis for the generalized reliability index according to the formula (6.2.1). We need even not require that the probability density ψ_n possesses moments of first and second order. If the density possesses these moments, we need not require that the covariance matrix is the unit matrix. From the rotation symmetry it only follows that given that the covariance matrix exist it is proportional to the unit matrix. However, simplicity reasons make us require that the following extra rules are satisfied for ψ_n :

4. The function ψ_n is continuous and the corresponding second-moment matrix is the unit matrix.
5. For all n and $m < n$ the product rule

$$\psi_n(x_1, \dots, x_n) = \psi_m(x_1, \dots, x_m) \psi_{n-m}(x_{m+1}, \dots, x_n) \quad (6.2.2)$$

is valid.

Rule 5 implies the very convenient property

$$\int_{\mathbf{x} > \mathbf{x}_0} \psi_n(\mathbf{x}) \, d\mathbf{x} = \prod_{i=1}^n \left(\int_{x_i > x_{0i}} \psi_1(x) \, dx \right) \quad (6.2.3)$$

valid for all $\mathbf{x}_0 = (x_{01}, \dots, x_{0n}) \in \mathbb{R}^n$. . Due to the rotation symmetry this formula is also valid upon an arbitrary rotation of the coordinate system.

It can be shown that these rules imply that $\psi_1(x)$ is uniquely determined as the one-dimensional standardized normal density $\varphi(x)$ and thus that

$$\psi_n(x_1, \dots, x_n) = \varphi(x_1) \cdot \dots \cdot \varphi(x_n) \quad (6.2.4)$$

Hereafter it is easily seen that G in (6.2.1) is the inverse function Φ^{-1} to the standardized normal distribution function Φ . Thus the formulated requirements uniquely lead to the definition

$$\beta(a) = \Phi^{-1} \left(\int_{\mathcal{S}_a} \varphi(x_1) \cdot \dots \cdot \varphi(x_n) \, dx_1 \cdot \dots \cdot dx_n \right) \quad (6.2.5)$$

of the generalized reliability index. For brevity we will in general omit the word “generalized” in the following. The integral over \mathcal{S}_a in (6.2.5) can be interpreted as a probability

$$p = \int_{\mathcal{S}_a} \varphi(x_1) \cdot \dots \cdot \varphi(x_n) \, dx_1 \cdot \dots \cdot dx_n \quad (6.2.6)$$

and the reliability index β as the fractile

$$\beta = \Phi^{-1}(p) \quad (6.2.7)$$

corresponding to p in the standardized normal distribution. However, once more it is emphasized that the assignment of the density ψ_n defined by (6.2.4) is not an indication of use of distributional information about the input variables \mathbf{X} . Only the second-moment representation of \mathbf{X} reflects the reliability. The assignment of the density (6.2.4) is solely a formal mathematical tool that provides a rational extension of the simple reliability index to a larger class of limit-state surfaces. The extension is one of several possible and therefore it is arbitrary. However, by requiring that (6.2.2) is satisfied, a unique extension is obtained which is particularly simple with respect to calculations. Thus it is not claimed that \mathbf{X} has a normal distribution in the sense that such a property is based on data. Mathematically we may describe the assignment in (6.2.4) in short terms by saying that \mathbf{X} has a normal distribution. It should then be remembered that this statement does not reflect empirical information about the reality.

Remark 6.1 Assume that there is sufficient data available, not just for the choice of the second-moment representation for \mathbf{X} , but also to state that the normal distribution fits well with the data. Then p , as calculated by (6), is interpretable as a relative frequency of the occurrence of the event S . However, if p has been given the formal role as a calculational quantity on which the definition of the generalized reliability index is based, then such an interpretation is erroneous or doubtful, at least. Since the mentioned information about distributional type is added on top of the second-moment information, it is in conflict with common-sense engineering to claim that there is the same reliability with respect to overpassing the limit state as if only the second-moment information is available. That p by (1) has the same value is irrelevant for this reliability evaluation problem. The core of the matter is that one cannot use (1) both in the one situation and in the other situation with the purpose of comparing the results and thereby determine an ordering with respect to safety. In fact, we are dealing with two different reliability models that should not be mixed together. Any reliability analysis model is constrained solely to handle elements of information of certain types. Within the same model varying amounts of information are reflected in a rational way by varying

reliability measures. Information that cannot be formally represented in terms of the elements of the model cannot be taken advantage of by use of the model. If engineering considerations show that the not represented information is of essential technical importance, the model must be replaced by a more detailed model. Comparisons between the different models can in general only be made through the study of the technical consequences of the models. Thus one must turn to the principle of consequence calculation mentioned in Chapter 1. It is clear from this that the choice of model becomes a question of establishment of codes of practice for reliability evaluation. \square

Example 6.2 A structure is loaded successively by an uncorrelated sequence of random loads $X_1, X_2, \dots, X_m, \dots$ all with mean value μ_X and standard deviation σ_X . The structure has a random resistance Y against failure. This means that failure occurs at the earliest at load application number $m + 1$ if and only if

$$Y - X_1 > 0, Y - X_2 > 0, \dots, Y - X_m > 0 \quad (6.2.8)$$

The resistance has the mean value μ_Y , the standard deviation σ_Y and is uncorrelated with the loads. We want to calculate the generalized reliability index with respect to failure before load application number $m + 1$ [4.1]. Therefore we assume that X_1, X_2, \dots, X_m and Y are normally distributed. The conditional failure probability, given that $Y = y$, obviously becomes

$$1 - \Phi\left(\frac{y - \mu_X}{\sigma_X}\right)^m = \Phi[-\beta_m(u)] \quad (6.2.9)$$

where $\beta_m(u)$ expressed as a function of

$$u = \frac{y - \mu_Y}{\sigma_Y} \quad (6.2.10)$$

is the conditional generalized reliability index given that $Y = y$. In particular we have

$$\beta_1(u) = \frac{y - \mu_X}{\sigma_X} = \frac{u\sigma_Y + \mu_Y - \mu_X}{\sigma_X} \quad (6.2.11)$$

and thus (6.2.9) can be written as

$$\beta_m(u) = \Phi^{-1}\{\Phi[\beta_1(u)]^m\} \quad (6.2.12)$$

Let us assume that $\sigma_X/\sigma_Y = 2$ and that the structure is designed such that the simple reliability index

$$\beta_1 = \frac{E[Y - X_1]}{D[Y - X_1]} = \frac{\mu_Y - \mu_X}{\sqrt{\sigma_X^2 + \sigma_Y^2}} \quad (6.2.13)$$

has the value $\beta_1 = 5$. Then (6.2.12) specializes to

$$\beta_m(u) = \Phi^{-1}\left\{\Phi\left[\frac{1}{2}u + \frac{5\sqrt{5}}{2}\right]^m\right\} \quad (6.2.14)$$

The graphs for this function are shown for $m = 1, 10, 100, 1000$, and 10000 in Fig. 6.2.

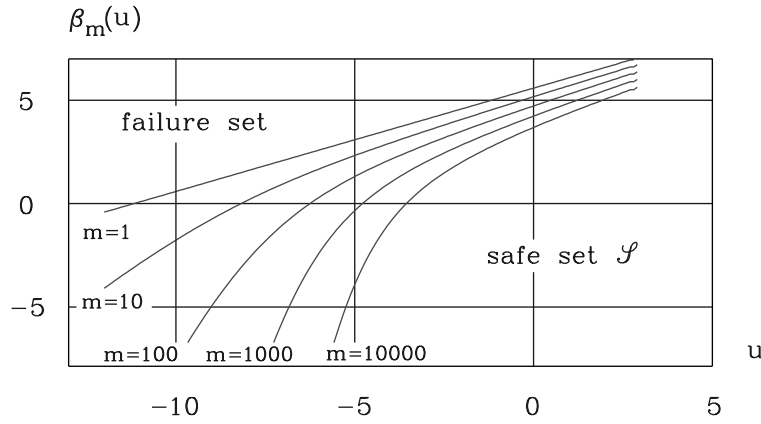

Figure 6.2: Conditional generalized reliability index $\beta_m(u)$ for given resistance $Y = \sigma_Y u + \mu_Y$ and m independent load applications.

m	β	$\beta/\sqrt{1+\beta'^2}$	$\{1+\dots\}$	$\beta_m < \approx$	$\Phi^{-1}[\Phi(\beta_1)^m]$
1	5.590	5.000	1	5.00	5.00
10	5.175	4.562	0.994	4.53	4.54
100	4.727	4.084	0.989	4.04	4.02
1000	4.236	3.560	0.981	3.49	3.44
10000	3.687	2.976	0.966	2.88	2.76

Table 6.1: Data for Example 6.2

The total formal probability that the structure survives the m first load applications hereafter becomes

$$\Phi(\beta_m) = \int_{-\infty}^{\infty} \Phi[\beta_m(u)]\varphi(u) du = \int_{-\infty}^{\infty} du \int_{-\infty}^{\beta_m(u)} \varphi(u)\varphi(v) dv = \int_{\mathcal{S}} \varphi(u)\varphi(v) du dv \quad (6.2.15)$$

At this stage the original $(m+1)$ -dimensional problem is reduced to a 2-dimensional problem for the mutually independent standardized normally distributed variables U and V in which the inequality $v \leq \beta_m(u)$ defines the safe set \mathcal{S} . From the convex curvature properties of the limit-state curves it follows that the geometric reliability index calculated in this 2-dimensional space is an upper limit to the generalized reliability index β_m defined by (6.2.15).

The limit-state curves in Fig. 6.2 can be approximated by their curvature circles at the points $(0, \beta_m(0))$. By calculating the distances from the origin to these circles followed by Taylor expansion we obtain

$$\beta_m < (\approx) \frac{\beta}{\sqrt{1+\beta'^2}} \left\{ 1 + \frac{\beta\beta'^2\beta''}{2[\beta\beta'' + (1+\beta'^2)^2]} \right\} \quad (6.2.16)$$

where $\beta = \beta_m(0)$, $\beta' = \beta'_m(0)$, $\beta'' = \beta''_m(0)$. The formula (6.2.16) is valid generally for convex limit-state curves that qualitatively are shaped as in Fig. 6.2.

The values are given in Table 6.1. The last column in the table is the generalized reliability index calculated under the incorrect assumption that $Y - X_1, \dots, Y - X_m$ are mutually independent. The dependency through the common term Y is in this case seen to have a very modest influence on the generalized reliability index. Under suitable assumptions this small influence of the dependency between different modes of failure turns out to be of a general nature.

While the geometric reliability index in the original formulation space is independent of m and equal to 5 the generalized reliability index decreases with m . \square

6.3 Reliability index bounds for convex polyhedral safe sets

As an important example of the practical possibilities of calculating the reliability index we consider the case where the safe set is polyhedral and convex. Let the limit state be composed of m hyperplanes such that the safe set is defined as the intersection of the m half-spaces given by the conditions

$$M_1 > 0, \dots, M_m > 0 \quad (6.3.1)$$

where M_i is the linear safety margin corresponding to the i th hyperplane, see Fig. 6.3.

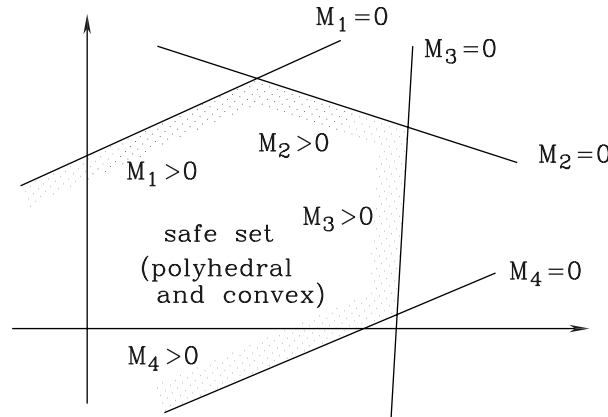

Figure 6.3: Polyhedral and convex safe set.

The formal probability mass

$$p = P(M_1 > 0, \dots, M_m > 0) = P(-M_1 < 0, \dots, -M_m < 0) \quad (6.3.2)$$

on the safe set is determined by the formal assignment of the normal distribution to the input variables X_1, \dots, X_n . The set of safety margins M_1, \dots, M_m is then jointly normally distributed since each safety margin is an inhomogeneous linear function of X_1, \dots, X_n . It appears from (6.3.2) that p is the value at $(0, \dots, 0)$ of the joint distribution function for $(-M_1, \dots, -M_m)$. Obviously we have

$$p = \Phi_m(\boldsymbol{\beta}; \mathbf{P}_M) \quad (6.3.3)$$

where $\boldsymbol{\beta} = (\beta_1, \dots, \beta_m)$ is the vector of simple reliability indices

$$\beta_i = \frac{E[M_i]}{D[M_i]} \quad (6.3.4)$$

and $\mathbf{P}_M = \{\rho[M_i, M_j]\}$ is the correlation matrix for \mathbf{M} , that is, the matrix of the correlation coefficients corresponding to $\mathbf{M} = (M_1, \dots, M_m)$. The function $\Phi_m(\mathbf{x}; \mathbf{P})$ is the m -dimensional normal distribution function that corresponds to all mean values being zero, all variances being 1, and the correlation matrix being \mathbf{P} .

If \mathbf{P} is regular, the normal distribution is said to be regular and otherwise to be singular. If $m > n$, the normal distribution is always singular but it can be singular also for $m \leq n$, of course. When the distribution is singular, the entire probability mass is concentrated on a subspace of the m -dimensional space. This subspace has dimension equal to the rank of the correlation matrix (or what is the same, the rank of the covariance matrix $\text{Cov}[\mathbf{M}, \mathbf{M}^T]$).

The practical applicability of the reliability theory on problems that are more general than the problems that correspond to "almost plane" limit-state surfaces is thus restricted by the possibilities of calculating values of the m -dimensional normal distribution function $\Phi_m(\mathbf{x}; \mathbf{P})$ for any correlation matrix \mathbf{P} . In particular this is valid for points $\mathbf{x} = \boldsymbol{\beta}$, where the elements of $\boldsymbol{\beta}$ have suitably large positive values such that the formal failure probability $1 - p = 1 - \Phi_m(\mathbf{x}; \mathbf{P})$ is small.

Both in this and in the next chapter we will treat different methods for approximate calculation of $\Phi_m(\mathbf{x}; \mathbf{P})$. In this section we will derive an exact bounding of $1 - p$ both from below and from above. For this it is convenient to work with set indicator functions (zero - one variables). We define

$$\mathbf{1}_A(\mathbf{x}) = \begin{cases} 1 & \text{if } A \text{ is true for } \mathbf{x} \text{ (or if } \mathbf{x} \in A) \\ 0 & \text{otherwise} \end{cases} \quad (6.3.5)$$

in which A is either a statement, such as $M_1 > 0$, or a set. The indicator function for the safe set \mathcal{S} defined by all the statements in (6.3.1) being true is then determined by the product

$$\mathbf{1}_{\mathcal{S}} = \mathbf{1}_{\mathcal{S}_1} \cdot \dots \cdot \mathbf{1}_{\mathcal{S}_m} \quad (6.3.6)$$

where $\mathbf{1}_{\mathcal{S}_i} = \mathbf{1}_{M_i > 0}$, $i = 1, \dots, m$. For brevity we will write $\mathbf{1}_{\mathcal{S}_i}$ as $\mathbf{1}_i$ in the immediately following equations. Then we have

$$\begin{aligned} 1 - \mathbf{1}_{\mathcal{S}} &= 1 - \mathbf{1}_1 \cdot \dots \cdot \mathbf{1}_m = 1 - \mathbf{1}_1 \\ &\quad + \mathbf{1}_1(1 - \mathbf{1}_2) \\ &\quad + \mathbf{1}_1\mathbf{1}_2(1 - \mathbf{1}_3) + \dots \\ &\quad + \mathbf{1}_1\mathbf{1}_2 \cdot \dots \cdot \mathbf{1}_{m-1}(1 - \mathbf{1}_m) \end{aligned} \quad (6.3.7)$$

Moreover we have

$$\mathbf{1}_1\mathbf{1}_2 \cdot \dots \cdot \mathbf{1}_i \begin{cases} = \max\{1 - \sum_{j=1}^i (1 - \mathbf{1}_j), 0\} \\ \leq \mathbf{1}_j \quad \text{for } j \leq i \end{cases} \quad (6.3.8)$$

where the last inequality is obvious. The right side of the equality can at most be 1, and only if $\mathbf{1}_j = 1$ for all j . But in this case the left side also takes the value 1. In all other cases both sides are zero.

By substitution of (6.3.8) in (6.3.7) we get

$$1 - \mathbf{1}_{\mathcal{S}} = 1 - \mathbf{1}_1 + \sum_{i=2}^m \max\{(1 - \mathbf{1}_i)[1 - \sum_{j=1}^{i-1} (1 - \mathbf{1}_j)], 0\} \quad (6.3.9)$$

and

$$\begin{aligned} 1 - \mathbf{1}_{\mathcal{S}} &\leq 1 - \mathbf{1}_1 + \sum_{i=2}^m [(1 - \mathbf{1}_i) \min\{\mathbf{1}_1, \mathbf{1}_2, \dots, \mathbf{1}_{i-1}\}] \\ &= 1 - \mathbf{1}_1 + \sum_{i=2}^m [(1 - \mathbf{1}_i)(1 - \max\{1 - \mathbf{1}_1, 1 - \mathbf{1}_2, \dots, 1 - \mathbf{1}_{i-1}\})] \\ &= \sum_{i=1}^m (1 - \mathbf{1}_i) - \sum_{i=2}^m \max_{j < i} \{(1 - \mathbf{1}_i)(1 - \mathbf{1}_j)\} \end{aligned} \quad (6.3.10)$$

Thus

$$\mathbf{1}_{\mathcal{F}} \begin{cases} = \mathbf{1}_{\mathcal{F}_1} + \sum_{i=2}^m \max\{\mathbf{1}_{\mathcal{F}_i} - \sum_{j=1}^{i-1} \mathbf{1}_{\mathcal{F}_i} \mathbf{1}_{\mathcal{F}_j}, 0\} \\ \leq \sum_{i=1}^m \mathbf{1}_{\mathcal{F}_i} - \sum_{i=2}^m \max_{j < i} \{\mathbf{1}_{\mathcal{F}_i} \mathbf{1}_{\mathcal{F}_j}\} \end{cases} \quad (6.3.11)$$

where $\mathbf{1}_{\mathcal{F}} = 1 - \mathbf{1}_{\mathcal{S}}$ is the indicator function for the complementary set to \mathcal{S} , and correspondingly for the sets marked with indices.

Since for two random variables X and Y we have that $X \leq Y \Rightarrow E[X] \leq E[Y]$ (which follows from the positivity of the expectation functional (4.2.10)), (6.3.11) gives the probability inequalities

$$P(\mathcal{F}) \begin{cases} \geq P(\mathcal{F}_1) + \sum_{i=2}^m \max\{P(\mathcal{F}_i) - \sum_{j=1}^{i-1} P(\mathcal{F}_i \cap \mathcal{F}_j), 0\} \\ \leq \sum_{i=1}^m P(\mathcal{F}_i) - \sum_{i=2}^m \max_{j < i} \{P(\mathcal{F}_i \cap \mathcal{F}_j)\} \end{cases} \quad (6.3.12)$$

Here it is used that the expectation of a random indicator function $\mathbf{1}_A$ is the same as the probability $P(A)$ of the event A . The inequalities (6.3.12) are valid for an arbitrary probability distribution. In the definition of the generalized reliability index we formally have assigned a normal distribution to the space of input variables such that this normal distribution has the same second-moment representation as the vector of input variables \mathbf{X} . Therefore we can use (6.3.12) for bounding of the reliability index

$$\beta = -\Phi^{-1}[P(\mathcal{F})] \quad (6.3.13)$$

by setting

$$P(\mathcal{F}_i) = \Phi(-\beta_i) \quad (6.3.14)$$

$$P(\mathcal{F}_i \cap \mathcal{F}_j) = \Phi_2(-\beta_i, -\beta_j; \rho_{ij}), \quad j = 1, \dots, m \quad (6.3.15)$$

where the function $\Phi_2(x, y; \rho)$ is the distribution function of the two-dimensional normal distribution with mean values $(0, 0)$, variances $(1, 1)$ and correlation coefficient ρ (Exercise 4.3).

It follows directly by considering Fig. 6.4 that

$$\Phi_2(-\beta_i, -\beta_j; \rho_{ij}) \begin{cases} \geq \max\{\Phi(-\beta_i)\Phi(-\beta_{j|i}), \Phi(-\beta_j)\Phi(-\beta_{i|j})\} \\ \leq \Phi(-\beta_i)\Phi(-\beta_{j|i}) + \Phi(-\beta_j)\Phi(-\beta_{i|j}) \end{cases} \quad (6.3.16)$$

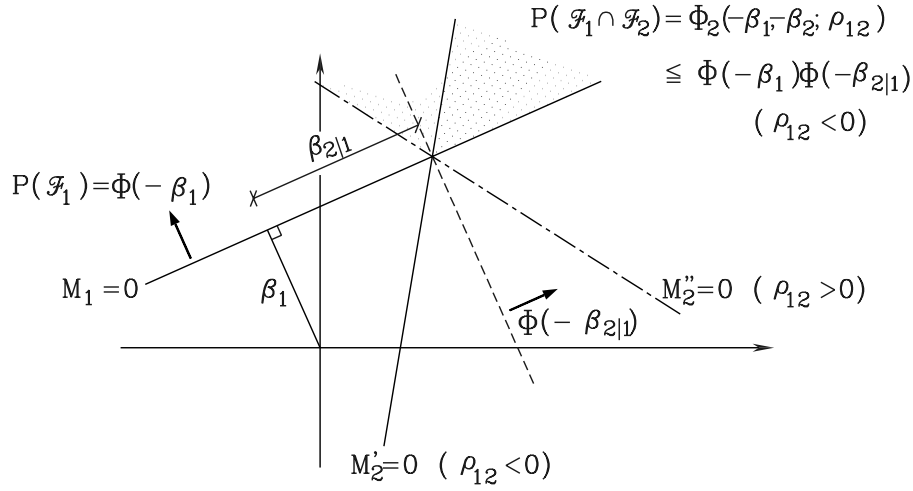

Figure 6.4: Geometric illustration of the normalized space with proof of (6.3.16) and (6.3.17).

for $\rho_{ij} > 0$ while

$$\Phi_2(-\beta_i, -\beta_j; \rho_{ij}) \leq \min\{\Phi(-\beta_i)\Phi(-\beta_{j|i}), \Phi(-\beta_j)\Phi(-\beta_{i|j})\} \tag{6.3.17}$$

for $\rho_{ij} < 0$. The conditional reliability index $\beta_{i|j}$ is, see (4.4.14),

$$\beta_{i|j} = \frac{\hat{E}[M_i | M_j = 0]}{\hat{D}[M_i | M_j = 0]} = \frac{\beta_i - \rho_{ij}\beta_j}{\sqrt{1 - \rho_{ij}^2}} \tag{6.3.18}$$

This can also be seen from Fig. 6.4 by use of the fact that the correlation coefficient $\rho[M_i, M_j]$ is $\cos \nu$ where ν is the angle between the two outwards directed normal vectors to the hyperplanes.

In many practical situations it is sufficient to use (6.3.16) and (6.3.17) for the evaluation of the terms $P(\mathcal{F}_i \cap \mathcal{F}_j)$ on the right side of (6.3.12).

Example 6.3 Figure 6.5 shows a steel truss loaded by self weight q_1 and snow load q_2 [4.1]. The loads are considered as constants while the yield resistances of the bars are random with given mean values and standard deviations. The yield resistances are assumed to be equicorrelated with the correlation coefficient $\rho \geq 0$. Equicorrelation can originate from a common random term (common except for proportionality) while the variation beyond the contribution from this common term is represented by mutually independent random variables.

Yielding of any of the 13 bars defines a failure mode for the truss structure. The corresponding safety margins are linear. For the sake of simplicity we will assume that the compression bars are prevented from loss of stability through constructive means. The exercise is then to design the bars such that the generalized reliability index with respect to failure of the truss in any mode gets a specified value β_{truss} . For further simplification of the example the design problem is restricted to the special case where the cross-section areas of the bars are chosen such that all the individual failure modes get a common simple reliability index β . Thus the exercise is reduced to the determination of β for a given value of β_{truss} .

The $m = 13$ linear safety margins become

$$M_i = Y_i - a_i q_1 - b_i q_2, \quad i = 1, \dots, 13 \quad (6.3.19)$$

where a_i, b_i are influence coefficients while Y_i is the yield force for the i th bar (compression or tension dependent of what is relevant). Since the loads are constants, the safety margins become equicorrelated with the correlation coefficient ρ . We then have that

$$P(\mathcal{F}_i) = \Phi(-\beta) \quad (6.3.20)$$

and according to (6.3.18) that

$$\beta_{i|j} = \beta \sqrt{\frac{1-\rho}{1+\rho}} \quad (6.3.21)$$

so that (6.3.15) and (6.3.16) give

$$1 \leq \frac{P(\mathcal{F}_i \cap \mathcal{F}_j)}{\Phi(-\beta)\Phi\left(-\beta\sqrt{\frac{1-\rho}{1+\rho}}\right)} \leq 2 \quad (6.3.22)$$

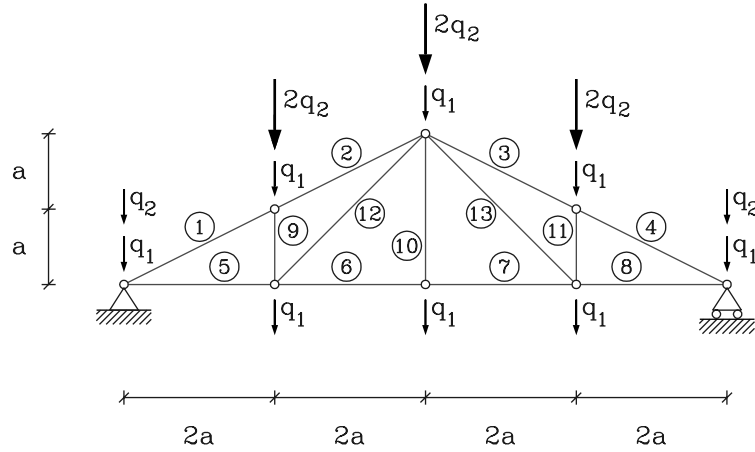

Figure 6.5: Truss structure with load definitions.

Hereafter it follows from (6.3.12) that

$$\begin{aligned} \frac{P(\mathcal{F})}{\Phi(-\beta)} &\geq 1 + \sum_{i=2}^m \max \left\{ 1 - 2(i-1)\Phi\left(-\beta\sqrt{\frac{1-\rho}{1+\rho}}\right), 0 \right\} \\ &= \max_{j \in \{1, \dots, m\}} \sum_{i=1}^j \left\{ 1 - 2(i-1)\Phi\left(-\beta\sqrt{\frac{1-\rho}{1+\rho}}\right) \right\} \\ &= \max_{j \in \{1, \dots, m\}} \left\{ j \left[1 - (j-1)\Phi\left(-\beta\sqrt{\frac{1-\rho}{1+\rho}}\right) \right] \right\} \end{aligned} \quad (6.3.23)$$

where the maximal value is obtained for j equal to the integer closest to the number

$$\frac{1}{2} \left[1 + \frac{1}{\Phi \left(-\beta \sqrt{\frac{1-\rho}{1+\rho}} \right)} \right] \quad (6.3.24)$$

The upper bound obtained from (6.3.12) is

$$\frac{P(\mathcal{F})}{\Phi(-\beta)} \leq m - (m-1) \Phi \left(-\beta \sqrt{\frac{1-\rho}{1+\rho}} \right) \quad (6.3.25)$$

In particular for $\rho = 0$ we find that the generalized reliability index β_{truss} is bounded as follows:

$$-\Phi^{-1} \{ \Phi(-\beta) [13 - 12\Phi(-\beta)] \} \leq \beta_{\text{truss}} \leq -\Phi^{-1} \{ \Phi(-\beta) [13 - 156\Phi(-\beta)] \} \quad (6.3.26)$$

For values of practical interest there is a very small difference between the two bounds. Obviously the exact value is

$$\beta_{\text{truss}} = \Phi^{-1} [\Phi(\beta)^{13}] \approx -\Phi^{-1} [13\Phi(-\beta)] \quad (6.3.27)$$

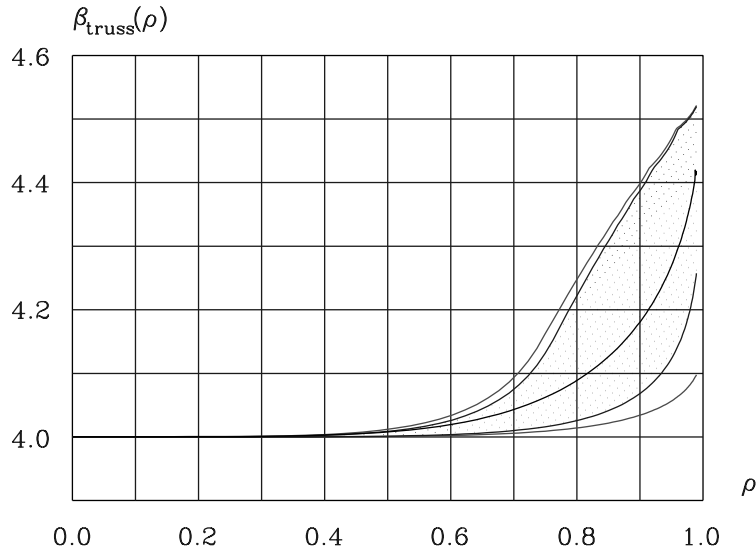

Figure 6.6: Upper and lower bound for the generalized reliability index β_{truss} for the truss structure in Fig. 6.5 as a function of the correlation coefficient ρ between the bar yield resistances. The middle curve shows the exact reliability index (Remark 6.2).

For a specified value of β_{truss} as for example $\beta_{\text{truss}} = 4$, the formula (6.3.27) gives the value $\beta = 4.57$ for the design of the individual bars. This value of β is used for the curves in Fig. 6.6.

The solid line shows the bounds for $\beta_{\text{truss}}(\rho)$ determined by (6.3.23) and (6.3.25) as functions of $\rho \in [0, 1]$. The maximal value of the bracketed term $\{\dots\}$ in (6.3.23) is obtained for $j = 13$ when $\rho \leq 0.748$. For $\rho = 0.8, 0.9, 1$ the optimal bound is obtained for $j = 8, 4, 1$, respectively. The bounds of the shaded domain are determined by use of the exact integral formula (4.5.11) for $\Phi_2(-\beta, -\beta; \rho)$ in (6.3.15).

Figure 6.6 shows that $\beta_{\text{truss}}(\rho)$ is almost independent of ρ up to as large a value as about 0.5 to 0.6. This practical limit for independence of ρ increases with the reliability index β . Furthermore the figure illustrates that the two bounds are almost coincident for ρ less than about 0.5 to 0.6. \square

Remark 6.2 Let X, X_1, \dots, X_m be mutually independent standardized normally distributed random variables and consider the m safety margins

$$M_i = \beta_i + \sqrt{\rho} X + \sqrt{1-\rho} X_i, \quad i = 1, \dots, m \quad (6.3.28)$$

They are seen to be equicorrelated with the correlation coefficient ρ . They all have the variance 1 and M_i has the mean value β_i . Then

$$\begin{aligned} P(M_1 > 0, \dots, M_m > 0) &= \int_{-\infty}^{\infty} P(M_1 > 0, \dots, M_m > 0 | X = x) \varphi(x) dx \\ &= \int_{-\infty}^{\infty} \left[\prod_{i=1}^m P(M_i > 0 | X = x) \right] \varphi(x) dx = \int_{-\infty}^{\infty} \left[\prod_{i=1}^m \Phi\left(\frac{\beta_i + \sqrt{\rho}x}{\sqrt{1-\rho}}\right) \right] \varphi(x) dx \end{aligned} \quad (6.3.29)$$

which in particular for $\beta_1 = \dots = \beta_m = \beta$ becomes

$$P(M_1 > 0, \dots, M_m > 0) = \int_{-\infty}^{\infty} \Phi\left(\frac{\beta + \sqrt{\rho}x}{\sqrt{1-\rho}}\right)^m \varphi(x) dx \quad (6.3.30)$$

The reliability problem considered in Example 6.3 can therefore be solved by a single integral. The graph for the corresponding function $\beta_{\text{truss}}(\rho)$ is shown in Fig. 6.6. \square

Example 6.4 The frame structure shown in Fig. 6.7 is analyzed with respect to carrying capacity by use of the yield hinge theory corresponding to ideal plasticity [4.1]. The yield moments Y_1, \dots, Y_5 are assumed to be uncorrelated random variables with a common mean value μ and a standard deviation σ . The principle of virtual work gives the following three linear safety margins

$$\mathbf{M} = \begin{bmatrix} M_1 \\ M_2 \\ M_3 \end{bmatrix} = \begin{bmatrix} M_1 \\ M_2 \\ M_3 \end{bmatrix} \begin{bmatrix} 1 & 0 & 2 & 2 & 1 \\ 0 & 1 & 2 & 1 & 0 \\ 1 & 1 & 0 & 1 & 1 \end{bmatrix} \begin{bmatrix} Y_1 \\ Y_2 \\ Y_3 \\ Y_4 \\ Y_5 \end{bmatrix} - \begin{bmatrix} Fa + Gb \\ Gb \\ Fa \end{bmatrix} \quad (6.3.31)$$

corresponding to each of the mechanisms shown in Fig. 6.7.

The limit-state surface in the five-dimensional space of the yield moments is convex and polyhedral. The angles $\nu_{12}, \nu_{13}, \nu_{23}$ between the normal vectors to the hyperplanes in the corresponding normalized space are given by, see (4.2.45),

$$\begin{aligned} \cos \nu_{12} &= \text{Corr}[M_1, M_2] = \sqrt{6/10} \approx 0.775, & \nu_{12} &\approx 39^\circ \\ \cos \nu_{13} &= \text{Corr}[M_1, M_3] = \sqrt{4/10} \approx 0.632, & \nu_{13} &\approx 51^\circ \\ \cos \nu_{23} &= \text{Corr}[M_2, M_3] = \sqrt{1/6} \approx 0.408, & \nu_{23} &\approx 66^\circ \end{aligned} \quad (6.3.32)$$

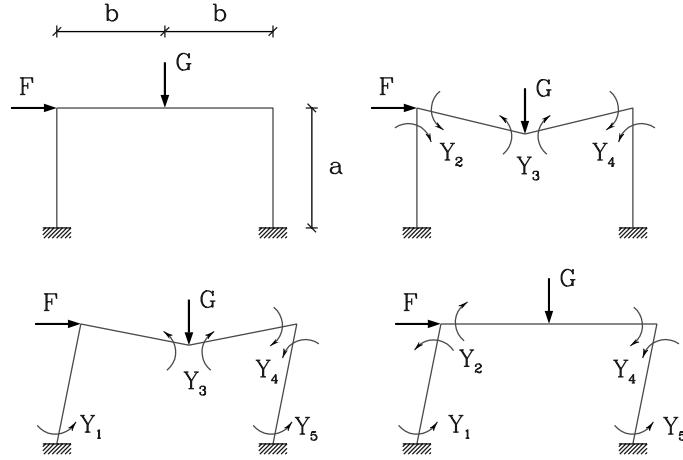

Figure 6.7: Yield hinge model for frame structure.

We will consider the simple but special case where the three simple reliability indices $\beta_i = E[M_i]/D[M_i]$, $i = 1, 2, 3$, have the common value β . The conditional reliability index (6.3.18) becomes

$$\beta_{i|j} = \sqrt{\frac{1 - \rho_{ij}}{1 + \rho_{ij}}} \quad (6.3.33)$$

and it follows from (6.3.15) and (6.3.16) that

$$\Phi(-\beta)p_{ij} \leq P(\mathcal{F}_i \cap \mathcal{F}_j) \leq 2\Phi(-\beta)p_{ij} \quad (6.3.34)$$

where $p_{ij} = \Phi(-\beta_{i|j})$. The inequalities (6.3.12) imply that the probability of collapse $P(\mathcal{F})$ has the lower bound

$$P(\mathcal{F}) \geq \Phi(-\beta)[3 - 2(p_{12} + p_{13} + p_{23})] \quad (6.3.35)$$

and the upper bound

$$P(\mathcal{F}) \leq \Phi(-\beta)[3 - 2(p_{12} + p_{13} + p_{23}) + \min\{p_{12}, p_{13}, p_{23}\}] \quad (6.3.36)$$

that both correspond to the numeration of the three mechanisms that give the closest bounds. From this the following bounding of the generalized reliability index is obtained: $3.74 < \beta_{\text{frame}} < 3.76$ for $\beta = 4$ and $4.78 < \beta_{\text{frame}} < 4.80$ for $\beta = 5$.

If we calculate the probability of collapse under the assumption of independence between the three safety margins we get

$$P(\mathcal{F}) = 1 - \Phi(\beta)^3 \approx 3\Phi(-\beta) \quad (6.3.37)$$

which gives $\beta_{\text{frame}} = 3.73$ and 4.78 for $\beta = 4$ and 5 , respectively. Thus we see that the correlation between the safety margins is almost without influence on the generalized reliability index.

It is important not to mix up the insensitivity of the generalized reliability index with respect to correlation between several (in series) contributing safety margins with the effect of correlation between input variables as Y_1, \dots, Y_5 . The correlation between the input variables can naturally have a substantial influence on the standard deviations of the individual safety margins and thus on their reliability indices. \square

6.4 Asymptotic reliability index for curved limit-state surface. Definition of “almost plane” limit-state surface (single-point FORM or SORM)

Let the limit-state surface in the standardized Gaussian space have its globally most central point on the x_n -axis. This can always be achieved by rotating the coordinate system. Moreover, assume that the limit-state surface is twice differentiable in a neighborhood of the globally most central point.

As illustrated in Fig. 6.8 place a “circular” cylinder \mathcal{C} in \mathbb{R}^n with the x_n -axis as axis. Let \mathbb{R}^{n-1} here designate the special subspace of \mathbb{R}^n described by the $n-1$ first coordinates of $(x_1, \dots, x_{n-1}, x_n)$. The projection of the cylinder on \mathbb{R}^{n-1} is then a sphere \mathcal{K} .

We will make the assumption that the intersection between \mathcal{C} and the limit state surface makes a piece of a surface whose projection on \mathbb{R}^{n-1} is the entire sphere \mathcal{K} . By use of Taylor’s formula we can represent this surface piece by an equation of the form

$$x_n = \beta + \frac{1}{2} \mathbf{z}^T \mathbf{A} \mathbf{z} + o(\mathbf{z}^T \mathbf{z}), \quad \mathbf{z} \in \mathcal{K} \quad (6.4.1)$$

where β is the geometric reliability index, \mathbf{A} is a constant matrix and $\mathbf{z} = (x_1, \dots, x_{n-1})$.

By the affinity $y_n = \gamma x_n$, $\mathbf{y} = \gamma \mathbf{z}$ with respect to the origin using an affinity factor $\gamma \geq 1$ we generate a surface piece with the equation

$$y_n = \gamma \beta + \frac{1}{2\gamma} \mathbf{y}^T \mathbf{A} \mathbf{y} + \gamma o\left(\frac{\mathbf{y}^T \mathbf{y}}{\gamma^2}\right), \quad \mathbf{y} \in \mathcal{K} \quad (6.4.2)$$

The corresponding geometric reliability index is $\gamma \beta$.

Let \mathcal{F}_γ denote the failure set relative to the limit state that corresponds to the value of the affinity factor in (6.4.2). Our goal in the following is to derive an asymptotic formula for the formal failure probability $P(\mathbf{X} \in \mathcal{F}_\gamma)$ as $\gamma \rightarrow \infty$. Readers who are less interested in the derivation may jump to equation (6.4.10).

First we will use the asymptotic formula

$$\Phi(-x) \sim \frac{\varphi(x)}{x} \quad \text{as } x \rightarrow \infty \quad (6.4.3)$$

that is, for any $\epsilon_1 > 0$ there is a value x_0 such that

$$\left| \frac{\varphi(x)}{x\Phi(-x)} - 1 \right| < \epsilon_1 \quad \text{for } x > x_0 \quad (6.4.4)$$

With y_n given by (6.4.2) we thus have

$$P(\mathbf{X} \in \mathcal{F}_\gamma \cap \mathcal{C}) = \int_{\mathcal{K}} \Phi(-y_n) \varphi_{n-1}(\mathbf{y}) \, d\mathbf{y} \sim \int_{\mathcal{K}} \frac{\varphi(y_n)}{y_n} \varphi_{n-1}(\mathbf{y}) \, d\mathbf{y} \quad (6.4.5)$$

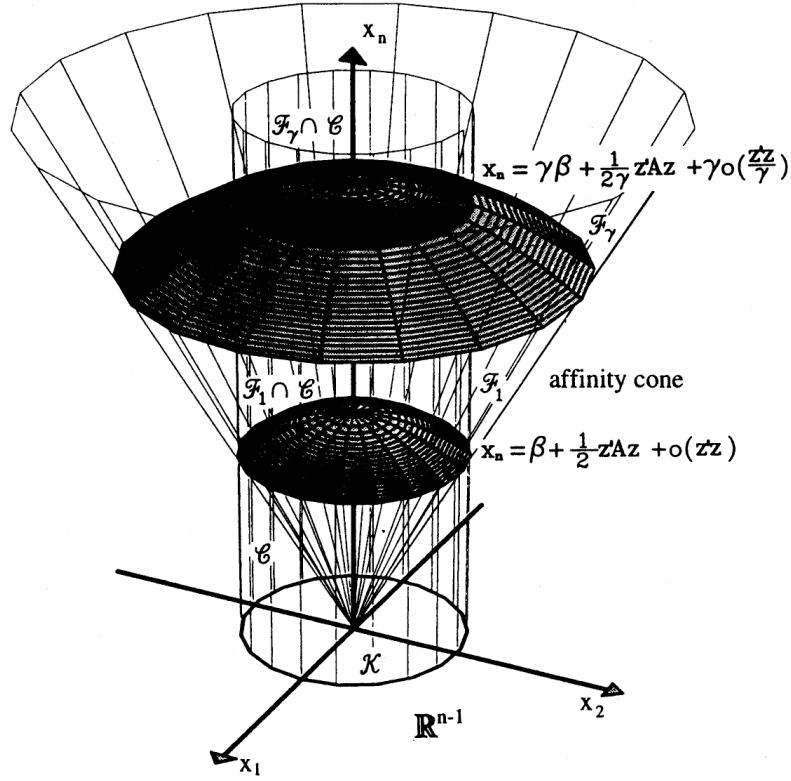

Figure 6.8: Illustration of cylinder \mathcal{C} , sphere \mathcal{K} , limit-state surface, and affinity with respect to the origin with factor $\gamma \geq 1$.

where the relative error after “ \sim ” is less than ϵ_1 when γ is chosen suitably large in dependence of ϵ_1 . The function $\varphi_{n-1}(\mathbf{y})$ is the standardized normal density in the $(n-1)$ -dimensional space. By substitution of y_n from (6.4.2) it is seen that the last integral in (6.4.5) can be written as

$$\frac{\varphi(\gamma\beta)}{\gamma\beta} \left(\frac{1}{\sqrt{2\pi}}\right)^{n-1} \int_{\mathcal{X}} \exp\left[-\frac{1}{2}\mathbf{y}^\top(\mathbf{I} + \beta\mathbf{A})\mathbf{y}\right] \frac{\exp[\gamma^2 o(\mathbf{y}^\top\mathbf{y}/\gamma^2)]}{1 + [1/(2\gamma^2\beta)]\mathbf{y}^\top\mathbf{A}\mathbf{y} + o(\mathbf{y}^\top\mathbf{y}/\gamma^2)} d\mathbf{y} \quad (6.4.6)$$

where \mathbf{I} is the unit matrix. The fraction behind the integral is for an arbitrary choice of $\epsilon_2 > 0$ bounded to the interval $[1 - \epsilon_2, 1 + \epsilon_2]$ for γ suitably large. With a relative error less than ϵ_2 we can therefore replace the fraction in (6.4.6) by 1. Thus we have from (6.4.5)

$$P(\mathbf{X} \in \mathcal{F}_\gamma \cap \mathcal{C}) \sim \Phi(-\gamma\beta) \left(\frac{1}{\sqrt{2\pi}}\right)^{n-1} \int_{\mathcal{X}} \exp\left[-\frac{1}{2}\mathbf{y}^\top(\mathbf{I} + \beta\mathbf{A})\mathbf{y}\right] d\mathbf{y} \quad (6.4.7)$$

using (6.4.3) to replace $\varphi(\gamma\beta)/(\gamma\beta)$ by $\Phi(-\gamma\beta)$.

We now assume that the absolute values of the elements in the matrix \mathbf{A} are sufficiently small for the matrix $\mathbf{I} + \beta\mathbf{A}$ to be positive definite, that is, for all the eigenvalues of $\mathbf{I} + \beta\mathbf{A}$ to be positive. Then the integrand in (6.4.7) is proportional to a normal distribution density defined by the inverse

covariance matrix $\mathbf{I} + \beta\mathbf{A}$. If we rotate the coordinate system about the x_n -axis, we can achieve that \mathbf{A} becomes a diagonal matrix

$$\mathbf{A} = [\alpha_1 \dots \alpha_{n-1}] \quad (6.4.8)$$

By this rotation the sphere \mathcal{K} maps onto itself such that the integral in (6.4.7) can be written

$$\prod_{i=1}^{n-1} (1 + \beta\alpha_i)^{-1/2} \int_{\mathcal{K}} \prod_{i=1}^{n-1} \left\{ \frac{1}{\sqrt{2\pi}} \exp\left[-\frac{1}{2}(1 + \beta\alpha_i)x_i^2\right] d(x_i \sqrt{1 + \beta\alpha_i}) \right\} \quad (6.4.9)$$

If \mathcal{K} is replaced by \mathbb{R}^{n-1} , the integral in (6.4.9) obviously becomes 1. Therefore we could from the start have chosen the radius of the cylinder \mathcal{C} and thus the radius of the sphere \mathcal{K} so large that the integral in (9) deviates arbitrarily little from 1. Thus we have shown that as $\gamma \rightarrow \infty$:

$$P(\mathbf{X} \in \mathcal{F}_\gamma \cap \mathcal{C}) \sim \Phi(-\gamma\beta) \prod_{i=1}^{n-1} (1 + \beta\alpha_i)^{-1/2} \quad (6.4.10)$$

in which the right-hand side is independent of the choice of \mathcal{C} . This is Breitung's asymptotic curvature-correction formula. The numbers $\alpha_1, \dots, \alpha_n$ can be interpreted by use of (6.4.1) on the form

$$x_n = \beta + \frac{1}{2}(\alpha_1 x_1^2 + \dots + \alpha_{n-1} x_{n-1}^2) + o(\mathbf{z}^\top \mathbf{z}) \quad (6.4.11)$$

It is seen that

$$\alpha_i = \left[\frac{\partial^2 x_n}{\partial x_i^2} \right]_{\mathbf{z}=\mathbf{0}} = -\kappa_i \quad (6.4.12)$$

where κ_i is the i th principal curvature at the most central point on the limit-state surface. It is noted that the sign is chosen such that positive principal curvatures correspond to local convexity of the safe set.

The result (6.4.10) does not allow the conclusion that the left-hand side of (6.4.10) can be replaced by $P(\mathbf{X} \in \mathcal{F})$ where $\mathcal{F} = \mathcal{F}_1$. However, there is a more involved proof that the formula is also valid for $P(\mathbf{X} \in \mathcal{F})$. For our practical use of the formula this is of minor importance. This is because we always can choose \mathcal{C} with so large a radius that $P(\mathbf{X} \in \mathcal{F} \cap \mathcal{C}^c)$ is much smaller than the right side of (6.4.10) within the relevant value domain of β . To this is added that the result merely is an asymptotic result for which the error for finite values of β is unknown. However, the result illustrates clearly the fundamental importance of the geometric reliability index and of the curvature properties of the limit state surface at the most central limit-state point.

It is also useful to note that the generalized reliability index (here denoted as β_G) asymptotically is equal to the geometric reliability index $\gamma\beta$ as $\gamma \rightarrow \infty$. This is seen in the following way. According to the right hand side of (6.4.10) we have that

$$\Phi(-\beta_G) = k\Phi(-\gamma\beta) \quad (6.4.13)$$

where k is the product factor in (6.4.10) and where β_G corresponds to the formal probability on the right side of (6.4.10). It follows from (6.4.13) that $\beta_G \rightarrow \infty$ as $\gamma \rightarrow \infty$. Let us assume that

$k > 1$. Then $\gamma\beta/\beta_G > 1$ during the passage to the limit. Moreover, let us assume that it is not true that $\gamma\beta/\beta_G \rightarrow 1$ as $\gamma \rightarrow \infty$. Then there is an $\epsilon > 0$ and a sequence $\gamma_1, \gamma_2, \dots \rightarrow \infty$ such that $\gamma_i\beta/\beta_G > 1 + \epsilon$ for all i . If (6.4.3) is used on (6.4.13) we get

$$\frac{\gamma\beta}{\beta_G} \sim k \frac{\varphi(\gamma\beta)}{\varphi(\beta_G)} = k \exp\left\{-\frac{1}{2}\beta_G^2 \left[\left(\frac{\gamma\beta}{\beta_G}\right)^2 - 1\right]\right\} \quad (6.4.14)$$

For the sequence $\gamma_1, \gamma_2, \dots$ the right-hand side of (6.4.14) converges to 0 while the left-hand side is larger than 1. This is a contradiction and we can conclude that

$$\beta_G \sim \gamma\beta \quad (6.4.15)$$

asymptotically as $\gamma \rightarrow \infty$. A similar argument can be applied for $k < 1$. It now follows from (6.4.14) that

$$2 \log k - [(\gamma\beta)^2 - \beta_G^2] \rightarrow 0 \quad \text{as } \gamma \rightarrow \infty \quad (6.4.16)$$

or

$$\beta_G^2 \sim (\gamma\beta)^2 + \log\left(\frac{1}{k}\right)^2 = (\gamma\beta)^2 + \sum_{i=1}^{n-1} \log(1 - \beta\kappa_i) \quad (6.4.17)$$

If $\beta\kappa_i \ll 1$ for all $i = 1, \dots, n-1$, we get from this that

$$\beta_G \sim \gamma\beta \sqrt{1 - \frac{1}{\gamma^2\beta} \sum_{i=1}^{n-1} \log \kappa_i} \approx \gamma\beta - \frac{1}{2\gamma} \sum_{i=1}^{n-1} \kappa_i \quad (6.4.18)$$

asymptotically as $\gamma \rightarrow \infty$, where $\sum_{i=1}^{n-1} \kappa_i$ is the first curvature invariant at the most central point on the limit-state surface, that is, on the surface that corresponds to $\gamma = 1$. This curvature invariant equals the trace in the matrix $-\mathbf{A}$, see (6.4.12) and (6.4.8).

The formulas (6.4.17) or (6.4.18) can be used to judge the accuracy by which the geometric reliability index approximates the generalized reliability index when the limit-state surface is twice differentiable in a neighborhood of the most central point. We can also use (6.4.18) for making the characterization "almost plane" precise. For example, if we decide that β_G is sufficiently accurate if the error is less than about 5% of the geometric reliability index, then we can characterize the limit state surface as being almost plane if

$$\left| \sum_{i=1}^{n-1} \beta\kappa_i \right| \leq \frac{(\gamma\beta)^2}{10} \quad (6.4.19)$$

Since the left side of this inequality is independent of γ , the set of limit-state surfaces that are almost plane will increase together with the geometric reliability index $\gamma\beta$.

Methods for the calculation of failure probabilities and generalized reliability indices without correction for curvature of the limit state surface at the most central point are often denoted under the abbreviation FORM (First Order Reliability Method). Methods that include the curvature correction similarly are denoted under the abbreviation SORM (Second Order Reliability Method). If

only the globally most central limit-state point is taken into account, the methods can be characterized as “single-point FORM” or “single-point SORM”.

Remark 6.3 For a plane curve given by the equation $g(x_1, x_2) = 0$ where g is twice differentiable, the curvature at an arbitrary point can be determined by the formula

$$\kappa = -\frac{g_{,11}g_{,2}^2 - 2g_{,12}g_{,1}g_{,2} + g_{,22}g_{,1}^2}{(g_{,1}^2 + g_{,2}^2)^{3/2}} \quad (6.4.20)$$

In practical reliability analysis problems the limit-state surfaces for the individual failure modes are often almost plane such that it is sufficiently accurate to apply FORM. When the curvature plays a role, it is most often solely with respect to some few of the active input variables. With only two input variables of this type, (6.4.20) can be used for calculation of the curvature correction factor in (6.4.10) or (6.4.18) with $\gamma = 1$.

In computer programs for SORM-analyses both the derivatives of g as well as the curvature are usually computed by numerical methods. Such calculations can be less accurate. A formula like (6.4.20) is therefore also useful for the control of the computer program. \square

6.5 Polyhedral approximation to arbitrary safe sets (multi-point FORM or SORM)

Evaluation of the integral in (6.2.6) for arbitrary safe sets \mathcal{S} may show large calculational difficulties. It is therefore an obvious goal to try to approximate \mathcal{S} with a simpler set for which the calculation can be done with less difficulties. The results of the two previous sections invite to use

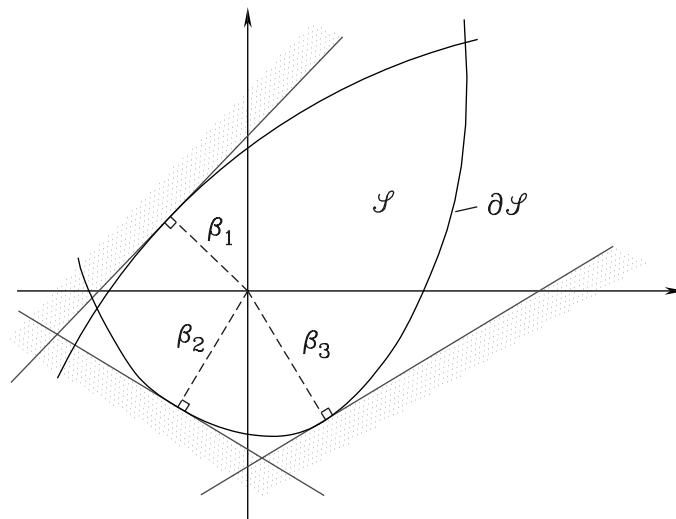

Figure 6.9: Multipoint FORM.

convex polyhedral sets whose faces are tangent hyperplanes to the limit-state surface $\partial\mathcal{S}$ at one

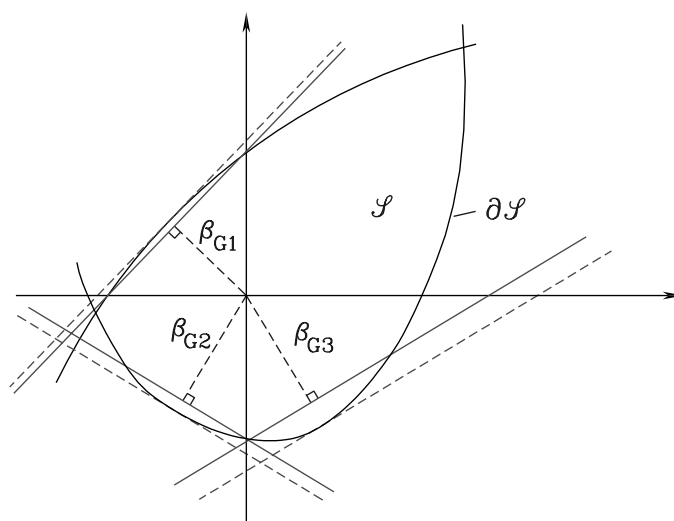

Figure 6.10: Multipoint SORM.

or more of the locally most central points on $\partial\mathcal{S}$. The use of just these points as tangent points ensures the convexity of the polyhedral set defined by the tangent hyperplanes, see Fig. 6.9.

We have seen in the previous sections that the most essential contributions to the failure probability come from the vicinities of the locally most central limit-state points if the distances from the origin in the standardized Gaussian space to these points are suitably large. This situation is most common in structural reliability. It is therefore to be expected that the polyhedral approximation often will give reliability index values of sufficient accuracy for practical purposes. This method of approximation can be characterized as “multi-point FORM”(Fig. 6.9).

If the curvatures of the limit-state surface at the locally most central points are so large that the assumption of almost plane surface is less good, a somewhat better approximating convex polyhedral set can be constructed by parallel shifts of the faces of the previously constructed polyhedral set by such amounts that the distances from the origin to the new hyperplanes equal the local generalized reliability indices determined by (6.4.17) or (6.4.18). This method can be characterized as “multi-point SORM” (Fig. 6.10).

Without using Monte Carlo simulation the possibilities of controlling the accuracy of the results that can be obtained by the methods of this and the previous section are limited to particularly simple examples in which analytical or numerical integration can be accomplished. In spite of long computation time, Monte Carlo simulation therefore gets a decisive role as a tool for control of the accuracy of fast approximative methods. This topic is considered in Chapter 9.

6.6 Polyhedral approximation at singular points on the limit-state surface (single-point multiple FORM or SORM)

Often certain points on the limit-state surface are singular in the sense that they are intersection points between several differentiable surfaces $\partial\mathcal{S}_1, \dots, \partial\mathcal{S}_m$. The sets $\mathcal{S}_1, \dots, \mathcal{S}_m$ make up the safe set \mathcal{S} for example as the intersection

$$\mathcal{S} = \cap_{i=1}^m \mathcal{S}_i \quad (6.6.1)$$

while the failure set is the union

$$\mathcal{F} = \cup_{i=1}^m \mathcal{F}_i \quad (6.6.2)$$

where \mathcal{F} is the complementary set to \mathcal{S} . This situation is relevant if the limit state is passed if just one of the events $\mathcal{F}_1, \dots, \mathcal{F}_m$ occurs. This corresponds to a situation where several different elements function together as a series system (chain system) in the sense that failure of the system occurs if just one of the elements fails, that is, if just one link in the chain fails. (These elements are not necessarily materialized. For example they can be collapse mechanisms as in Example 6.4. The convex polyhedral sets considered previously correspond to such series systems where the faces are the elements).

It is easy to see that if $\partial\mathcal{S}_1, \dots, \partial\mathcal{S}_m$ are differentiable surfaces, then no singular points on $\partial\mathcal{S}$ can be locally most central points in case \mathcal{S} is defined as the intersection (6.6.1). However, this can very well be the case if \mathcal{S} is defined as the union

$$\mathcal{S} = \cup_{i=1}^m \mathcal{S}_i \quad (6.6.3)$$

so that the failure set becomes the intersection

$$\mathcal{F} = \cap_{i=1}^m \mathcal{F}_i \quad (6.6.4)$$

This definition of \mathcal{S} corresponds to a situation where the individual elements work together as a parallel system. Failure of the system requires that all elements fail. At this place we will not go further into system considerations. Such considerations play an essential role for the evaluation of the reliability of statically indeterminate structures. This important topic is given an introductory treatment in Chapter 14.

Let us assume that q of the m limit-state surfaces $\partial\mathcal{S}_1, \dots, \partial\mathcal{S}_m$ have a nonempty intersection and let us for the sake of simplicity assume that they correspond to the q first indices. We will denote the set

$$\mathcal{K} = \partial\mathcal{S}_1 \cap \dots \cap \partial\mathcal{S}_q \quad (6.6.5)$$

as a ridge of \mathcal{S} (or of \mathcal{F}). Choose a point $\mathbf{x} \in \mathcal{K}$ and replace $\partial\mathcal{S}_i$ with the tangent hyperplane $\partial H_{i\mathbf{x}}$ to $\partial\mathcal{S}_i$ at \mathbf{x} and let $H_{i\mathbf{x}}$ be the half-space with boundary $\partial H_{i\mathbf{x}}$ that approximates \mathcal{F}_i for $i = 1, \dots, q$. In a Gaussian space, replacement of

$$\cap_{i=1}^q \mathcal{F}_i \quad \text{by} \quad \cap_{i=1}^q H_{i\mathbf{x}} \quad (6.6.6)$$

then leads to the approximation

$$P\left(\bigcap_{i=1}^q \mathcal{F}_i\right) \approx \Phi_q(-\boldsymbol{\beta}; \text{Corr}[\mathbf{M}, \mathbf{M}^T]) \quad (6.6.7)$$

where Φ_q is the distribution function for the q -dimensional normal distribution. In (6.6.7) the vector $\mathbf{M} = (M_{1,\mathbf{x}}, \dots, M_{q,\mathbf{x}})$ is defined as the vector of linear safety margins that correspond to the q tangent hyperplanes $\partial H_{1,\mathbf{x}}, \dots, \partial H_{q,\mathbf{x}}$ at \mathbf{x} , and $\boldsymbol{\beta}$ is the corresponding vector of the simple reliability indices.

The most central point on the ridge \mathcal{K} will normally be a good choice of the approximation point \mathbf{x} . It is noted that this point generally will not be a locally most central point on $\partial\mathcal{S}$.

6.7 Historical and bibliographical notes

The dimension-invariance problem connected to the geometric reliability index was pointed out by D. Veneziano in 1974 [6.9] and considered further by O. Ditlevsen in 1976 [6.3]. The generalized reliability index was suggested by O. Ditlevsen in 1979 [6.4].

The probability inequalities (6.3.12) was published by the statistician E.G. Kounias in 1968, [6.7]. However, his work remained unknown within the subject of structural safety until the beginning of the 1980s. The simple inequalities

$$\max_i P(\mathcal{F}_i) \leq P(\mathcal{F}) \leq \sum_{i=1}^m P(\mathcal{F}_i) \quad (6.7.1)$$

were applied for the evaluation of the reliability structural system by C.A. Cornell in 1967, [6.2]. In some relevant cases these simple bounds are rather wide. This fact motivated the formulation of the bounds in (6.3.12). E. Vanmarcke [6.8] published the upper probability bound in 1973 while the lower bound was formulated by O. Ditlevsen in 1979 [6.5]. The extensive applicability of the bounds for structural reliability evaluations was demonstrated by O. Ditlevsen and since then by several researchers in a large number of different examples.

The important asymptotic result (6.4.10) is given by K. Breitung in 1984 [6.1]. The approximation (6.6.7) is suggested by M. Hohenbichler in 1984, [6.6]. These works were made within a research group at Technische Universität München under the leadership of R. Rackwitz.

Bibliography

- [6.1] K. Breitung (1984) Asymptotic approximations for multinormal integrals. *Journal of Eng. Mech.*, ASCE, **110**, 357-366.
- [6.2] C.A. Cornell (1967) Bounds on the reliability of structural systems. *Journal of Struct. Mech. Division*, ASCE, **93**, 171-200.
- [6.3] O. Ditlevsen (1976) A collection of notes concerning structural reliability. *Proc. Second Int. Workshop on Definition, Classification and Evolution of Code Formats*, Mexico City, DIALOG 2-76, Danish Engineering Academy, Lyngby, Denmark.

- [6.4] O. Ditlevsen (1979) Generalized second moment reliability index. *Journal of Structural Mechanics*, **7**, 435-451.
- [6.5] O. Ditlevsen (1979) Narrow reliability bounds for structural systems. *Journal of Structural Mechanics*, **7**, 453-472.
- [6.6] M. Hohenbichler (1984) An asymptotic formula for the probability of intersections. *Berichte zur Zuverlässigkeitstheorie der Bauwerke*, Heft 69, LKI, Technische Universität, München.
- [6.7] E.G. Kounias (1968) Bounds for the probability of a union, with applications. *Ann. Math. Stat.*, **39**, 2154-2158.
- [6.8] E.H. Vanmarcke (1973) Matrix formulation of reliability analysis and reliability-based design. *Computers and Structures*, **3**, 757-770.
- [6.9] D. Veneziano (1974) *Contributions to Second Moment Reliability Theory*. Res. Rept. R74-33, Dept. of Civil Eng., MIT, Cambridge, USA.

Chapter 7

TRANSFORMATION

7.1 Informational asymmetry

The generalized reliability index was defined in the previous chapter in a natural way under the assumption that the sole available information about the input variables \mathbf{x} is that they are uncertain with their uncertainty quantified solely in terms of a second-moment representation. A fundamental assumption behind the definition is informational rotation symmetry in the normalized space. Both in theory and in practice there is usually more information of high quality available than solely the second moment representation of \mathbf{X} . Most obvious is symmetry disturbing restrictions that are satisfied of logical necessity or of physical reasons. Almost any physical quantity is bounded upwards or downwards or both. Often negative values are excluded as being in contradiction with the definition of the quantity. For example, negative tension strengths make no sense in usual modeling of mechanical phenomena.

However, in many cases it is only of minor practical importance that a model error is made by assuming that the definition domain of the mechanical model is the entire of \mathbb{R}^n in spite of the physical facts. This is because the boundary of the definition domain is far away from the origin of the normalized space as compared to the distance to the relevant limit state surface.

It is obvious that the existence of a boundary of the definition domain generally prevents the informational rotation symmetry with respect to the origin. If the definition domain is suitably regular, it is, however, in principle possible to represent the mechanical model and the considered n -dimensional limit-state problem by the aid of a new set of variables \mathbf{y} that without restrictions can take values everywhere in \mathbb{R}^n . This set of variables \mathbf{y} is obtained by a suitable one-to-one continuous mapping $\mathbf{y} = T(\mathbf{x})$ of the input variables \mathbf{x} into \mathbf{y} where the transformation T is chosen such that the map of the definition set is all of \mathbb{R}^n . The space of the map \mathbb{R}^n is formally covered with the normal distribution density that corresponds to the second-moment representation for the transformed random vector $\mathbf{Y} = T(\mathbf{X})$. However, this second moment representation is unknown while the second-moment representation $(E[\mathbf{X}], \text{Cov}[\mathbf{X}, \mathbf{X}^T])$ of the input variables \mathbf{X} is known. Therefore $(E[\mathbf{Y}], \text{Cov}[\mathbf{Y}, \mathbf{Y}^T])$ must be determined from the condition that the applied transformation $\mathbf{X} = T^{-1}(\mathbf{Y})$ transforms the normal distribution density in the \mathbf{y} -space into a formal density in the \mathbf{x} -space that corresponds to the known mean value vector $E[\mathbf{X}]$ and the known covariance matrix $\text{Cov}[\mathbf{X}, \mathbf{X}^T]$. After normalization of the \mathbf{y} -space such that it becomes standard

Gaussian we are back in the informational rotation symmetrical situation. Thus we can define the generalized reliability index on the basis of the representation of the limit-state surface in the \mathbf{y} -space.

In the following we will often use the notation \mathbf{u} -space for the standard Gaussian space, and \mathbf{U} will without further definition denote a random vector with standard Gaussian distribution.

Example 7.1 The most common situation is that in which one or more of the variables in \mathbf{X} solely can take positive values. If X is such a variable, a possibility is to apply a logarithmic transformation and to assume that $\log X$ is normally distributed. Then the following transformation formulas are valid:

$$E[\log X] = \log E[X] - \frac{1}{2} \log(1 + V_X^2) \quad (7.1.1)$$

$$\text{Var}[\log X] = \log(1 + V_X^2) \quad (7.1.2)$$

where

$$V_X = \frac{D[X]}{E[X]} \quad (7.1.3)$$

is the coefficient of variation of X . If $V_X^2 \ll 1$ we have

$$E[\log X] \approx \log E[X] \quad (7.1.4)$$

$$D[\log X] \approx V_X \quad (7.1.5)$$

If both X and Y are variables that are transformed logarithmically, we have

$$\text{Cov}[\log X, \log Y] = \log \left(1 + \frac{\text{Cov}[X, Y]}{E[X]E[Y]} \right) = \log(1 + \text{Corr}[X, Y] V_X V_Y) \quad (7.1.6)$$

which for $V_X V_Y \ll 1$ gives the approximations

$$\text{Cov}[\log X, \log Y] \approx \text{Corr}[X, Y] V_X V_Y \quad (7.1.7)$$

$$\text{Corr}[\log X, \log Y] \approx \text{Corr}[X, Y] \quad (7.1.8)$$

If only X is transformed, we get

$$\text{Cov}[\log X, Y] = \frac{\text{Cov}[X, Y]}{E[X]} = \text{Corr}[X, Y] V_X D[Y] \quad (7.1.9)$$

$$\text{Corr}[\log X, Y] = \text{Corr}[X, Y] \frac{V_X}{\sqrt{\log(1 + V_X^2)}} \quad (7.1.10)$$

$$\approx \text{Corr}[X, Y] \quad \text{for } V_X^2 \ll 1 \quad (7.1.11)$$

□

On the basis of the assumed level of information it is not possible by theoretical considerations alone to point out principles that show how the transformation T can be chosen in a unique way. Only criteria of simplicity seem to point at reasonable choices. In order to use the theory in

practice, standardized transformations must therefore necessarily be prescribed by an authorized code giving organization.

The situation is different if distributional information exists on top of the second-moment information and information about restrictions imposed by definitions and physical relations. If this distributional information is complete, it is reasonable to require that the transformation T should be exactly the one that transforms the given probability distribution for \mathbf{X} to the standardized normal distribution for \mathbf{Y} .

This complete state of information is an ideal state that hardly will show up in practice often. Usually the claimed probability distribution is chosen from a large class of distributions by comparison with sample data as given for example in terms of histograms. Thus there is a remaining problem about the arbitrary choice of the distributional type. This problem cannot be neglected when the domain of application is structural reliability. This is illustrated in the following example.

Example 7.2 Two engineers have each got the job of designing a steel cable such that the reliability against tension failure is fixed by a reliability index of $\beta = 4.75$. It is assumed that the cable can be manufactured such that with great accuracy it has a prescribed tension resistance R . The knowledge of the load S is uncertain, however. The engineers have available only a sample of possible load values without any given specifications of distribution types.

One engineer fits a normal distribution to the given data for S while the other engineer chooses to fit a logarithmic normal distribution; that is, this engineer transforms the given data logarithmically to the data for $\log S$ and assumes that $\log S$ is normally distributed. The sample shows no clear indications of whether the one or the other distribution should be preferred, that is, non of the hypotheses can be rejected by use of statistical test methods. The two engineers assign the same second-moment representation to S .

The two conflicting distribution assumptions imply that the tensile resistance should be R_N and R_{LN} , respectively, where

$$R_N = E[S](1 + \beta V_S) \quad (7.1.12)$$

$$\log R_{LN} = E[\log S](1 + \beta V_{\log S}) \quad (7.1.13)$$

From the formulas (7.1.1) and (7.1.2) it then follows that

$$\frac{R_N}{R_{LN}} = (1 + \beta V) \sqrt{1 + V^2} \exp\left(-\beta \sqrt{\log(1 + V^2)}\right) \quad (7.1.14)$$

where $V = V_S$. For $\beta = 4.75$ and $V_S = 0.1, 0.2, 0.3$ one finds that this ratio is 0.92, 0.78, 0.63, respectively. Thus the two engineers get completely different results solely due to arbitrary assumptions. This illustrates the so-called "tail-sensitivity problem".

The problem appears, naturally, because the prescription of a given value of the reliability index is insufficient without a prescription of the mathematical model by which the reliability index is defined. Reliability index values corresponding to different models can be compared only if they are transformed via their structural consequences. If in (7.1.12) and (7.1.13) we replace β with β_N and β_{LN} , respectively, we get that β_N is equivalent to β_{LN} with respect to the reliability if and only if $R_N = R_{LN}$, that is, if and only if

$$\beta_{LN} = \frac{\log[(1 + \beta_N V) \sqrt{1 + V^2}]}{\sqrt{1 + V^2}} \quad (7.1.15)$$

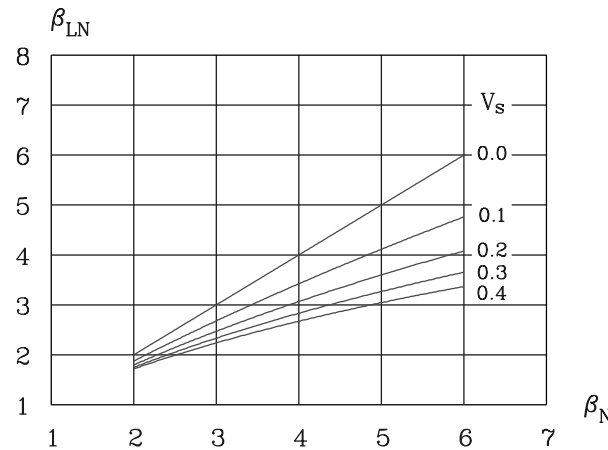

Figure 7.1: Equivalent reliability indices β_N and β_{LN} corresponding to the normal and the logarithmic normal distribution model, respectively.

This relation between β_N and β_{LN} is shown in Fig. 7.1. The use of the relation is a simple example of an application of the principle of consequence calculations for the calibration of one reliability index scale to another. \square

Since fitting of distributions to measured data only rarely can remove the problem about arbitrary model choice, it is necessary that codes about practical decision making concerning structural design uniquely specify those distribution types (or transformations) that are to be applied for different types of relevant input variables. In this way reliability comparisons in practice will only be influenced by second-moment information (or more liberally by n th-moment information). Such information is in general much less distorted by “false” information from arbitrary and unverifiable model formulation than information about distribution tails that extend far beyond the central domains of the distributions that are covered by data.

Thus it should be one of the most important goals of a code committee to summarize existent knowledge about the distributions of the basic input variables and to formulate this knowledge in terms of suitable standardization under consideration of reasonable principles of simplicity. As mentioned above it is important to note that whatever format is chosen for the code, it must be constructed such that individual engineering decisions derived from the code are solely influenced by second-moment information (n th-moment information). This is the supporting philosophy of the definition of the generalized reliability index.

As long as such authorized codes do not exist, practical applications of the reliability index must be supported on the principle of consequence calculations rather than on comparisons of the calculated failure probabilities with calculated or statistically observed probabilities of adverse events of a completely different nature than those related to the considered type of limit states for structures (e.g. traffic accidents, deaths due to tobacco smoking, etc). See also the remarks about the long-run model development in the section on the objectivity problem in Chapter 3.

7.2 Some important transformations

Marginal transformation. Nataf distribution

In this section we will introduce some of the most important transformations from the space of input variables \mathbf{x} to the standardized Gaussian space. The space of \mathbf{x} will be called the free physical formulation space ("free" because the input variables are free input variables – their values can without inconsistencies be chosen independently of each other).

A simple class of transformations is defined by the equations

$$\Phi(y_i) = F_i(x_i), \quad i = 1, \dots, n \quad (7.2.1)$$

where Φ is the standardized normal distribution function while F_1, \dots, F_n are absolutely continuous and increasing distribution functions. (A distribution function is said to be *absolutely continuous* if it can be expressed as an integral of a density function). The logarithmic transformation is a special example of (7.2.1) with

$$F_i(x_i) = \Phi\left(\frac{\log x_i - a}{b}\right) \quad (7.2.2)$$

where a and $b > 0$ are suitable constants that ensure that the y -space is normalized. The transformation (7.2.1) is obtained if one assumes that the random input variables X_1, \dots, X_n are mutually independent and have the distribution functions F_1, \dots, F_n , respectively.

If it cannot be assumed that X_1, \dots, X_n are mutually independent, the "marginal" transformation (7.2.1) applied to X_1, \dots, X_n will lead to random variables Y_1, \dots, Y_n that are not mutually independent. If the joint distribution of $\mathbf{X} = (X_1, \dots, X_n)$ is unknown except for the covariance matrix $\text{Cov}[\mathbf{X}, \mathbf{X}^T]$, it is reasonable to let $\mathbf{Y} = (Y_1, \dots, Y_n)$ have an n -dimensional normal distribution with a correlation matrix $\mathbf{P}_Y = \text{Cov}[\mathbf{Y}, \mathbf{Y}^T]$ that consistent with the transformation (7.2.1) corresponds to the given correlation matrix \mathbf{P}_X . In this way a unique n -dimensional probability density $f_X(x_1, \dots, x_n)$ is induced in the \mathbf{x} -space. The density is

$$f_X(x_1, \dots, x_n) = \frac{\partial(y_1, \dots, y_n)}{\partial(x_1, \dots, x_n)} \varphi_n(\mathbf{y}; \mathbf{P}_Y) \quad (7.2.3)$$

where

$$\frac{\partial(y_1, \dots, y_n)}{\partial(x_1, \dots, x_n)} = \frac{f_{X_1}(x_1) \cdot \dots \cdot f_{X_n}(x_n)}{\varphi(y_1) \cdot \dots \cdot \varphi(y_n)} \quad (7.2.4)$$

is the Jacobian of the transformation (7.2.1) while

$$\varphi_n(\mathbf{y}; \mathbf{P}_Y) = \frac{1}{\sqrt{(2\pi)^n \det \mathbf{P}_Y}} \exp\left(-\frac{1}{2} \mathbf{y}^T \mathbf{P}_Y^{-1} \mathbf{y}\right) \quad (7.2.5)$$

is the n -dimensional normal density corresponding to the mean values 0, the variances 1 and the correlation matrix \mathbf{P}_Y .

Denoting the correlation coefficient between X_i and X_j by r_{ij} and introducing the normalized variables $Z_i = (X_i - E[X_i])/D[X_i]$, we get the equation

$$r_{ij} = E[Z_i Z_j] = \int_{-\infty}^{\infty} \int_{-\infty}^{\infty} z_i z_j \varphi_2(y_i, y_j; \rho_{ij}) dy_i dy_j \quad (7.2.6)$$

for the determination of the correlation coefficient

$$\rho_{ij} = \text{Cov}[Y_i, Y_j] \quad (7.2.7)$$

by r_{ij} . The variable z_i is expressed by y_i through the formula

$$z_i = \frac{F_i^{-1}[\Phi(y_i)] - E[X_i]}{D[X_i]} \quad (7.2.8)$$

It is not always possible to determine a normal distribution that by (7.2.6) corresponds to the given correlation coefficients r_{ij} . If these correlation coefficients are too close to 1 or -1 it can happen that (7.2.6) has no solution. Moreover, it must be required that the solutions ρ_{ij} to (7.2.6) define a non-negative definite matrix $\{\rho_{ij}\}$.

In order to avoid the work of solving (7.2.6), some approximation formulas have been established for the ratio

$$R = \frac{\rho_{ij}}{r_{ij}} \quad (7.2.9)$$

These formulas are based on the following properties of the relation between $r = r_{ij}$ and $\rho = \rho_{ij}$:

1. ρ is an increasing function of r .
2. $\rho = 0 \Leftrightarrow r = 0$
3. $R \geq 1$
4. For given marginal distributions R is a constant if one of the marginals is normal and $R = 1$ if both the marginals are normal.
5. R is invariant with respect to increasing linear transformations of X_i and X_j .
6. R is independent of the parameters in a marginal two-parameter distribution that by a linear transformation can be reduced to a parameter-free form.
7. R is a function of the coefficient of variation in a marginal two-parameter distribution that cannot be reduced to a parameter free form.

We will not go through the proofs of these properties but refer to [7.13]. The approximation formulae for R are put together in Appendix 2. The distribution defined by (7.2.3) with (7.2.4) substituted is in the literature denoted as *Nataf's distribution* (see also Example 7.6).

Hermite polynomial transformation*

A useful special type of multidimensional distribution is obtained by defining the random variables X_1, \dots, X_n to be of the form

$$X = \sum_{k=0}^N a_k \text{He}_k(Y) \quad (7.2.10)$$

in which a_1, \dots, a_N are constant coefficients, Y is a standardized normal random variable, and $\text{He}_0(x) = 1$, $\text{He}_1(x) = x$, $\text{He}_2(x) = x^2 - 1$, $\text{He}_3(x) = x^3 - 3x$, $\text{He}_4(x) = x^4 - 6x^2 + 3, \dots$ are the Hermite polynomials defined by the identity

$$\begin{aligned} \frac{\varphi(t-x)}{\varphi(x)} &= \exp\left(-\frac{1}{2}(t^2 - tx)\right) = \sum_{n=0}^{\infty} (-1)^n \frac{t^n (t-2x)^n}{2^n n!} \\ &= \sum_{n=0}^{\infty} \frac{(-1)^n}{2^n n!} \sum_{i=0}^n \binom{n}{i} (-2x)^{n-i} t^{n+i} \\ &= \sum_{n=0}^{\infty} \frac{t^n}{k!} \sum_{i=0}^{[k/2]} \frac{(-1)^i k!}{i!(k-2i)!} \frac{x^{k-2i}}{2^i} \equiv \sum_{k=0}^{\infty} \frac{\text{He}_k(x)}{k!} t^k \end{aligned} \quad (7.2.11)$$

in which $[k/2] = k/2$ for k even and $[k/2] = (k-1)/2 = [(k-1)/2]$ for k odd. Referring directly to the Taylor expansion formula it is seen that $\text{He}_k(x)$ alternatively can be defined by the formula

$$\text{He}_k(x)\varphi(x) = \left[\frac{d^k}{dt^k} \varphi(t-x) \right]_{t=0} = (-1)^k \frac{d^k}{dx^k} \varphi(x) \quad (7.2.12)$$

Also it is seen from (7.2.11) that

$$\frac{d}{dx} \text{He}_k(x) = k \sum_{i=0}^{[(k-1)/2]} \frac{(-1)^i (k-1)!}{i!(k-1-2i)!} \frac{x^{k-1-2i}}{2^i} = k \text{He}_{k-1}(x) \quad (7.2.13)$$

It follows directly by integration of (7.2.12) that

$$E[\text{He}_k(Y)] = 0 \quad \text{for } k = 1, 2, \dots \quad (7.2.14)$$

The definition of the random variables X_i and X_j in accordance with (7.2.10) as linear combinations of Hermite polynomials of the standard Gaussian variables Y_i and Y_j , respectively, is particularly convenient because

$$\text{Cov}[\text{He}_m(Y_i), \text{He}_n(Y_j)] = \begin{cases} 0 & \text{for } m \neq n \\ n! \rho^n & \text{for } m = n > 0 \end{cases} \quad (7.2.15)$$

where $\rho = \rho_{ij} = \text{Cov}[Y_i, Y_j]$.

To prove (7.2.15) we use (7.2.11) and (7.2.13) to obtain

$$\begin{aligned}
& \frac{\partial}{\partial \rho} E[\text{He}_m(Y_i)\text{He}_n(Y_j)] \\
&= \int_{-\infty}^{\infty} \int_{-\infty}^{\infty} \text{He}_m(x)\text{He}_n(y) \frac{\partial^2 \varphi_2(x, y; \rho)}{\partial x \partial y} dx dy \\
&= \int_{-\infty}^{\infty} \text{He}_m(x) \left[\text{He}_n(y) \frac{\partial \varphi_2(x, y; \rho)}{\partial x} - \int \frac{d\text{He}_n(y)}{dy} \frac{\partial \varphi_2(x, y; \rho)}{\partial x} dy \right]_{-\infty}^{\infty} dx \\
&= -n \int_{-\infty}^{\infty} \int_{-\infty}^{\infty} \text{He}_m(x)\text{He}_{n-1}(y) \frac{\partial \varphi_2(x, y; \rho)}{\partial x} dx dy \\
&= -n \int_{-\infty}^{\infty} \text{He}_{n-1}(y) \left[\text{He}_m(x) \varphi_2(x, y; \rho) - \int \frac{d\text{He}_m(x)}{dx} \varphi_2(x, y; \rho) dx \right]_{-\infty}^{\infty} dy \\
&= mn \int_{-\infty}^{\infty} \int_{-\infty}^{\infty} \text{He}_{m-1}(x)\text{He}_{n-1}(y) \varphi_2(x, y; \rho) dx dy \\
&= mn E[\text{He}_{m-1}(Y_i)\text{He}_{n-1}(Y_j)]
\end{aligned} \tag{7.2.16}$$

valid for $m, n > 0$. By repeated use of this result we get

$$\frac{\partial^k}{\partial \rho^k} E[\text{He}_m(Y_i)\text{He}_n(Y_j)] = \frac{m!n!}{(m-k)!(n-k)!} E[\text{He}_{m-k}(Y_i)\text{He}_{n-k}(Y_j)] \tag{7.2.17}$$

valid for $m, n \geq k$, and thus also

$$\frac{\partial^{k-1}}{\partial \rho^{k-1}} E[\text{He}_m(Y_i)\text{He}_n(Y_j)] = \frac{m!n!}{(m-k+1)!(n-k+1)!} E[\text{He}_{m-k+1}(Y_i)\text{He}_{n-k+1}(Y_j)] \tag{7.2.18}$$

Since $\text{He}_0(x) = 1$ it follows from (7.2.14) that if $m > n$ and $k = n$, then the right side of (7.2.17) is zero for any value of ρ , and consequently the right side of (7.2.18) is also zero for any value of ρ because it is zero for $\rho = 0$. Proceeding recursively in this way decreasing k by 1 in each step it follows that (7.2.15) is valid in the case $m \neq n$.

For $m = n$ and $k = n - 1$ (7.2.17) becomes

$$\frac{\partial^{n-1}}{\partial \rho^{n-1}} \text{Cov}[\text{He}_m(Y_i), \text{He}_n(Y_j)] = (n!)^2 \rho \tag{7.2.19}$$

Recursive integration then leads to (7.2.15) for $n = m$.

It follows from (7.2.10) and (7.2.15) that

$$\text{Cov}[X_i, X_j] = \sum_{k=1}^N k! a_{ik} a_{jk} \rho_{ij}^k \tag{7.2.20}$$

Since

$$E[Y^n] = \begin{cases} 0 & \text{for } n \text{ odd} \\ 1 \cdot 3 \cdot 5 \cdot \dots \cdot (n-1) & \text{for } n \text{ even} \end{cases} \tag{7.2.21}$$

the moments $E[X^n]$ of any order n can be calculated analytically. For $a_0 = 0$ and $n = 3$, and writing $a_1 = a$, $a_2 = b$, $a_3 = c$, we have

$$\begin{aligned} E[X^n] &= E \left[\left(\sum_{k=1}^3 a_k \text{He}_k(Y) \right)^n \right] \\ &= \sum_{i=0}^n \binom{n}{i} \sum_{j=0}^i \binom{i}{j} a^j b^{i-j} c^{n-i} E[Y^j (Y^2 - 1)^{i-j} (Y^3 - 3Y)^{n-1}] \end{aligned} \quad (7.2.22)$$

which gives $E[X] = 0$, $E[X^2] = a^2 + 2b^2 + 6c^2$. Thus $D[X] = 1$ for

$$b = \pm \sqrt{(1 - a^2 - 6c^2)/2} \quad (7.2.23)$$

provided $a^2 + 6c^2 \leq 1$. If $D[X] = 1$ the moments $E[X^3]$ and $E[X^4]$ are the *skewness* α_3 and *kurtosis* α_4 , respectively, and we get the equations

$$\alpha_3 = \pm \sqrt{2(1 - a^2 - 6c^2)(2 + a^2 + 18ac + 42c^2)} \quad (7.2.24)$$

$$\alpha_4 = 15 + 228ac + 936c^2 - 12a^4 - 264a^3c - 864a^2c^2 - 432ac^3 - 2808c^4 \quad (7.2.25)$$

In a case where the distribution of X is only slightly different from the standardized normal distribution we have $|c| \ll 1$ and $a = 1 - \epsilon$ where $|\epsilon| \ll 1$. Then we find $b \approx \pm \sqrt{|\epsilon|}$, $\alpha_3 \approx 2\sqrt{|\epsilon|}(3 - 2\epsilon + 18c)$, and $\alpha_4 \approx 3 + 48\epsilon + 24c$ asymptotically as $\epsilon \rightarrow 0$ and $c \rightarrow 0$. Thus we have asymptotically

$$X \approx \left(1 - \frac{\alpha_3^2}{36} \right) Y + \frac{\alpha_3}{6} (Y^2 - 1) + \left(\frac{\alpha_4 - 3}{24} - \frac{\alpha_3^2}{18} \right) (Y^3 - 3Y) \quad (7.2.26)$$

as $\alpha_3 \rightarrow 0$ and $\alpha_4 \rightarrow 3$. Also we have that $D[X] \approx 1$ asymptotically, while $E[X] = 0$. By neglecting the term $\alpha_3/36 \ll 1$ the right side of (7.2.26) becomes identical to the cutoff after the third term of the so-called Cornish-Fisher expansion of an arbitrary density type random variable X , [7,8] p. 34.

Winterstein approximation*

The n -dimensional marginal Hermite polynomial transformation of third degree of the Gaussian distribution can be used to define an n -dimensional density that approximates the probability distribution of an arbitrary random vector $\mathbf{X} = (X_1, \dots, X_n)$ in the sense of having marginal coincidence of the first four moments and coincidence of the covariance matrices.

Assume that $E[X_i] = E[X_j] = 0$, $D[X_i] = D[X_j] = 1$, and $\text{Cov}[X_i, X_j] = r_{ij}$. Moreover, assume that the skewness and kurtosis of both variables are given. Then (7.2.24) and (7.2.25) can be solved with respect to a and c for each of the two variables and thus together with (7.2.23) give the two sets of coefficients a_{i1}, a_{i2}, a_{i3} and a_{j1}, a_{j2}, a_{j3} . As an approximation we may then replace X_i and X_j by the linear combinations

$$\tilde{X}_i = \sum_{k=1}^3 a_{ik} \text{He}_k(Y_i), \quad \tilde{X}_j = \sum_{k=1}^3 a_{jk} \text{He}_k(Y_j) \quad (7.2.27)$$

that due to useful applications by Winterstein will be denoted as W-polynomials in the following.

Next requiring that $\text{Cov}[\tilde{X}_i, \tilde{X}_j] = \text{Cov}[X_i, X_j] = r_{ij}$ for all $i, j \in \{1, \dots, n\}$ the correlation coefficients $\rho_{ij} = \text{Cov}[Y_i, Y_j]$ are obtained by solving (7.2.20) with respect to ρ_{ij} , that is, by solving each of the third-degree equations

$$6c_i c_j \rho^3 + 2b_i b_j \rho^2 - a_i a_j \rho - r_{ij} = 0 \quad (7.2.28)$$

with respect to ρ . Clearly, a root of (7.2.28) is only applicable as the value of ρ_{ij} , if the matrix $\{\rho_{ij}\}$ becomes non-negative definite. So even if (7.2.24) and (7.2.25) may have solutions with respect to a and c and $a^2 + 6c^2 \leq 1$, it is not necessarily so that the covariances r_{ij} can be reproduced. For the asymptotic case corresponding to (7.2.26) we obviously get $\rho_{ij} \approx r_{ij}$.

Example 7.3 In standardized form the gamma-distribution type is defined by the one-parameter family, see (A2.8),

$$f_k(x; k) = \frac{1}{\Gamma(k)} x^{k-1} e^{-x}, \quad k > 0, x \geq 0 \quad (7.2.29)$$

The mean and variance are

$$E[X] = \text{Var}[X] = k \quad (7.2.30)$$

and the skewness and kurtosis are

$$\alpha_3 = \frac{2}{\sqrt{k}}, \quad \alpha_4 = 3 + \frac{6}{k} \quad (7.2.31)$$

respectively. Table 7.1 lists the coefficients a, b, c as functions of values of k corresponding to the asymptotic expression (7.2.26) and the exact values as obtained by solving the equations (7.2.24) and (7.2.25). Fig. 7.2 (left) shows the corresponding W-polynomials in the range of values of

	k	1	4	10	25	100
a	asymptotic	1.000	1.000	1.000	1.000	1.000
	exact	0.894	0.973	0.989	0.996	0.999
b	asymptotic	0.333	0.167	0.105	0.067	0.033
	exact	0.314	0.163	0.104	0.066	0.033
c	asymptotic	0.028	0.007	0.003	0.001	0.000
	exact	0.023	0.007	0.003	0.001	0.000

Table 7.1: Three-term Hermite-expansion coefficients (Winterstein approximation) for the gamma distribution.

y from -15 to 5, that is, a range that is much larger than the range of probable values of the standard Gaussian variable Y . It is seen that the W-polynomials are not monotonously increasing. In particular the polynomial corresponding to $k = 1$ has a local minimum at $y \approx -1.592$ with minimal value $x \approx -0.924$. This value is passed to the negative side for y less than -10. Thus there is a completely negligible probability that the random W-polynomial takes a value less than

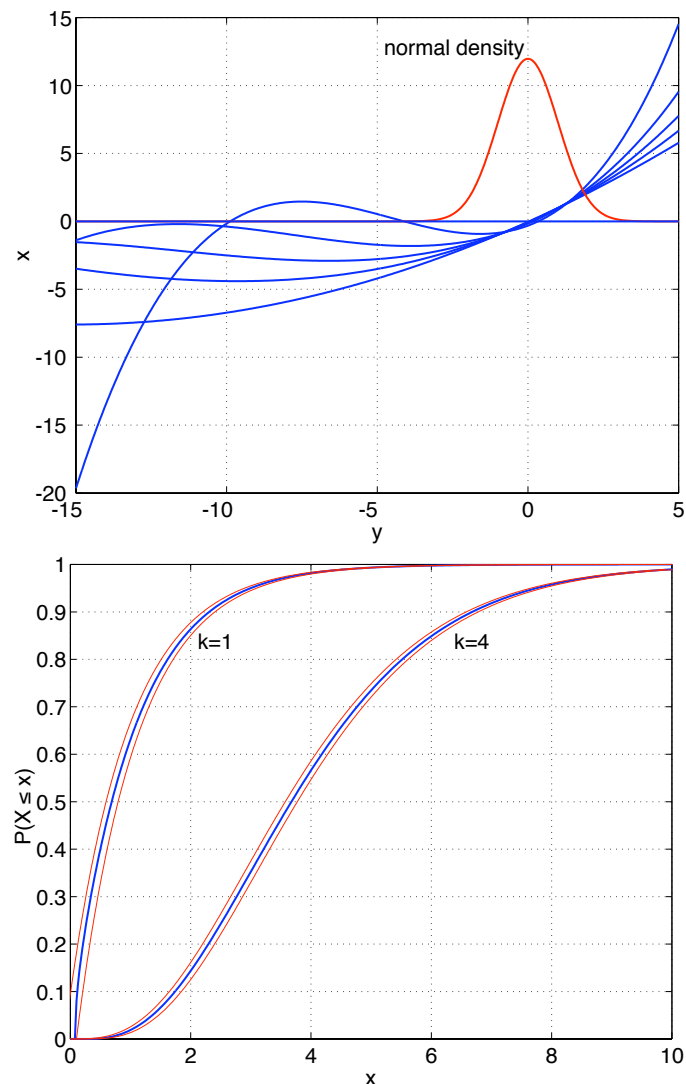

Figure 7.2: Left: W-polynomials for the standard gamma distributions (7.2.29) of mean $k = 1, 4, 10, 25, 100$ (top down). Right: Distribution functions for the two W-polynomials corresponding to $k = 1$ and 4 compared to the corresponding gamma distribution functions shifted ± 0.1 in the x -direction.

≈ -0.924 . The corresponding gamma distribution is the standard exponential distribution shifted to have mean zero. Shifting both distributions to mean 1 by adding 1 thus shows that the Winterstein approximation to the exponential distribution function is practically zero for $x \lesssim 1 - 0.924 = 0.076$. This is also seen in Fig. 7.2 (right) that compares the distribution functions for the random W-polynomials for $k = 1$ and $k = 4$ with the corresponding gamma distribution functions shifted ± 0.1 in the direction of the x -axis. The approximations are seen to be very good except in the vicinity of zero for the exponential distribution. \square

If X has a symmetric distribution we have $\alpha_3 = 0$ and it follows that $b = 0$ and

$$a^2 = 1 - 6c^2 \quad (7.2.32)$$

which upon substitution into (7.2.25) gives the equation

$$\alpha_4 = 3 + 216c^2 + 1944c^4 + 24c(1 - 48c)\sqrt{1 - 6c^2} \quad (7.2.33)$$

Example 7.4 The function

$$f_X(x) \propto \left(1 + \frac{x^2}{\nu}\right)^{-(\nu+1)/2}, \quad x \in \mathbb{R} \quad (7.2.34)$$

defines a density function for any $\nu > 0$. In particular, for ν an integer the distribution is called Student's t -distribution with ν degrees of freedom. It is symmetric about $x = 0$ and

ν	asymptotic		exact	
	a	c	a	c
5	1.000	0.2500	0.9684	0.1019
6	1.000	0.1250	0.9861	0.0679
8	1.000	0.0625	0.9946	0.0425
10	1.000	0.0417	0.9971	0.0314
15	1.000	0.0227	0.9989	0.0191
25	1.000	0.0119	0.9997	0.0108
50	1.000	0.0054	0.9999	0.0052
75	1.000	0.0035	1.0000	0.0034
100	1.000	0.0026	1.0000	0.0025

Table 7.2: Three-term Hermite-expansion coefficients (Winterstein approximation) for Student's t -distribution.

$$E[X] = 0 \quad (\nu > 1), \quad \text{Var}[X] = E[X^2] = \frac{\nu}{\nu - 2} \quad (\nu > 2) \quad (7.2.35)$$

$$\alpha_3 = 0 \quad (\nu > 3), \quad \alpha_4 = 3 + \frac{6}{\nu - 4} \quad (\nu > 4) \quad (7.2.36)$$

Table 7.2 lists the coefficients a and c as functions of values of $\nu > 4$ corresponding to the asymptotic expression (7.2.26) and the exact values as obtained by solving equation (7.2.33).

Fig. 7.3 (left) shows the W-polynomials for the five first values of ν in Table 7.2. Fig. 7.3 (right) compares the distribution function of the random W-polynomial with the corresponding t -distribution function for $\nu = 5$. It is seen that the approximation is not particular good in the central part of the distribution (in the probability range from about 5% to 95%). In the tail regions the approximation turns out to be reasonably good even though it should be remembered that the moments of order ν and higher order do not exist for the t -distribution while moments of all orders exist for the corresponding random W-polynomials. \square

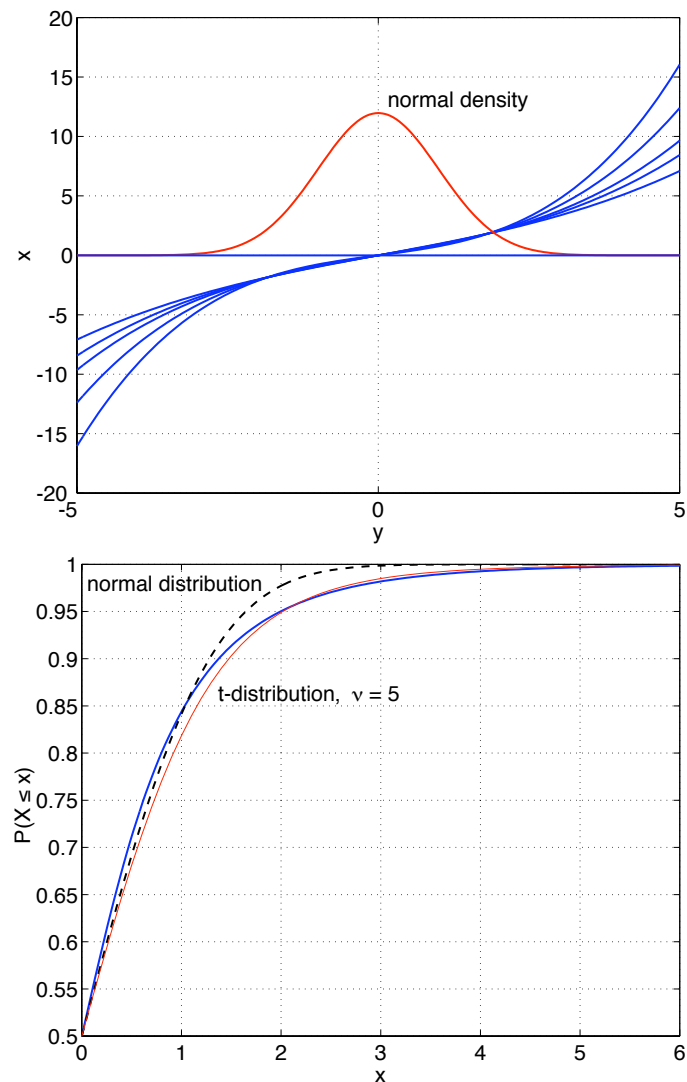

Figure 7.3: Left: W-polynomials for Student's t -distributions (7.2.34) of $\nu = 5, 6, 8, 10, 15$ (top down) degrees of freedom. Right: Distribution function for the W-polynomial corresponding to $\nu = 5$ (thick) compared to the corresponding t -distribution function (thin). The standard normal distribution is shown with dashed line.

Rosenblatt transformation

If a complete distributional description is given for \mathbf{X} in the form of a joint distribution function

$$P(X_1 \leq x_1, \dots, X_n \leq x_n) = F_{X_1, \dots, X_n}(x_1, \dots, x_n) \quad (7.2.37)$$

a transformation can be defined by successive conditioning:

$$\begin{aligned}
\Phi(u_1) &= F_{X_1}(x_1) \\
\Phi(u_2) &= F_{X_2}(x_2 | X_1 = x_1) \\
\Phi(u_3) &= F_{X_3}(x_3 | X_1 = x_1, X_2 = x_2) \\
&\vdots \\
\Phi(u_n) &= F_{X_n}(x_n | X_1 = x_1, X_2 = x_2, \dots, X_{n-1} = x_{n-1})
\end{aligned} \tag{7.2.38}$$

in which it is assumed that all the conditional distribution functions are absolutely continuous. In order to see that this one-to-one transformation maps \mathbf{X} into a standardized Gaussian random vector \mathbf{U} , we only need to note that the Jacobian in the identity

$$f_{U_1, \dots, U_n}(u_1, \dots, u_n) \frac{\partial(u_1, \dots, u_n)}{\partial(x_1, \dots, x_n)} = f_{X_1, \dots, X_n}(x_1, \dots, x_n) \tag{7.2.39}$$

follows from the equation

$$\frac{\partial(u_1, \dots, u_n)}{\partial(x_1, \dots, x_n)} \varphi(u_1) \cdot \dots \cdot \varphi(u_n) = f_{X_1}(x_1) f_{X_2}(x_2 | x_1) \dots f_{X_n}(x_n | x_1, x_2, \dots, x_{n-1}) \tag{7.2.40}$$

which is obtained by writing down the differential $d\mathbf{u}$ of the transformation (7.2.38). Since the functional matrix is a lower triangular matrix, the functional determinant becomes the product solely of the diagonal elements. Since the right side of (7.2.40) is just the right side of (7.2.39), it is seen by canceling of the Jacobian that

$$f_{U_1, \dots, U_n}(u_1, \dots, u_n) = \varphi(u_1) \cdot \dots \cdot \varphi(u_n)$$

and thus that \mathbf{U} is standardized Gaussian.

Example 7.5 Let (X, Y) have the density function

$$f_{X,Y}(x, y) = (x + y + xy) e^{-(x+y+xy)}, \quad (x, y) \in \mathbb{R}_+^2 \tag{7.2.41}$$

The marginal density function of X is

$$\begin{aligned}
f_X(x) &= \int_0^\infty f_{X,Y}(x, y) dy \\
&= e^{-x} \left[x \int_0^\infty e^{-(1+x)y} dy + (1+x) \int_0^\infty y e^{-(1+x)y} dy \right] \\
&= e^{-x} \left[\frac{x}{1+x} + \frac{1+x}{(1+x)^2} \right] = e^{-x}, \quad x \in \mathbb{R}_+
\end{aligned} \tag{7.2.42}$$

which is the density of the exponential distribution with parameter value 1. This result confirms that (7.2.41) is a density function. The conditional density of Y given $X = x$ is then

$$f_Y(y|x) = \frac{f_{X,Y}(x, y)}{f_X(x)} = (x + y + xy) e^{-(1+x)y}, \quad (x, y) \in \mathbb{R}_+^2 \tag{7.2.43}$$

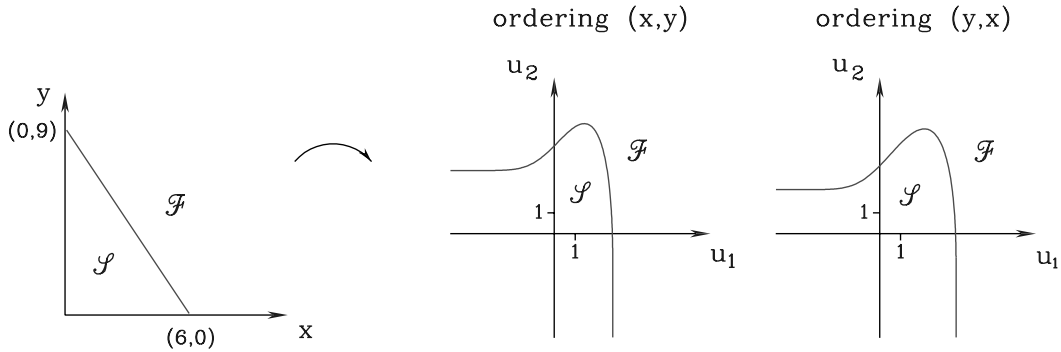

Figure 7.4: Mappings by the Rosenblatt transformations defined in Example 7.5.

with corresponding distribution function

$$F_Y(y|x) = \int_0^y [x + z(1+x)]e^{-(1+x)z} dz = 1 - (1+y)e^{-(1+x)y}, \quad (x, y) \in \mathbb{R}_+^2 \tag{7.2.44}$$

The Rosenblatt transformation corresponding to the ordering (x, y) then becomes

$$\begin{aligned} u_1 &= \Phi^{-1}(1 - e^{-x}) \\ u_2 &= \Phi^{-1}[1 - (1+y)e^{-(1+x)y}] \end{aligned} \tag{7.2.45}$$

Due to the symmetry in (7.2.41) between x and y , the Rosenblatt transformation corresponding to the ordering (y, x) is obtained by permutation of x and y in (7.2.45). Fig. 7.4 shows the map by each of the two Rosenblatt transformations of the straight line piece that connects $(0, 9)$ and $(6, 0)$ in the (x, y) -space. This straight-line piece can be thought of as representing a simple limit state in the free physical formulation space. It is seen that it is far away from being represented by a straight line in the Gaussian formulation space. \square

Example 7.6 For the distribution in Example 7.5 the covariance between X and Y can be calculated directly, or e.g. by first calculating

$$E[Y|X=x] = \int_0^\infty [1 - F_Y(y|x)] dy = \int_0^\infty (1+y)e^{-(1+x)y} dy = \frac{2+x}{(1+x)^2} \tag{7.2.46}$$

which, since $E[Y] = 1$, gives $\int_0^\infty (2+x)/(1+x)^2 e^{-x} dx = 1$, and then use (4.3.21):

$$\text{Cov}[X, Y] = \text{Cov}[X, E[Y|Y]] = \int_0^\infty \frac{x(2+x)}{(1+x)^2} e^{-x} dx - 1 \tag{7.2.47}$$

which can be evaluated as

$$\text{Cov}[X, Y] = \int_0^\infty \frac{e^{-x}}{1+x} dx - 1 = eE_1(1) - 1 = -0.40366\dots \tag{7.2.48}$$

where $E_1(1) = -\text{Ei}(-1) = \int_0^\infty e^{-t}/t dt$ is a value of the so-called exponential integral. Since $\text{Var}[X] = \text{Var}[Y] = 1$, the correlation coefficient becomes $r = -0.40366\dots$. The corresponding

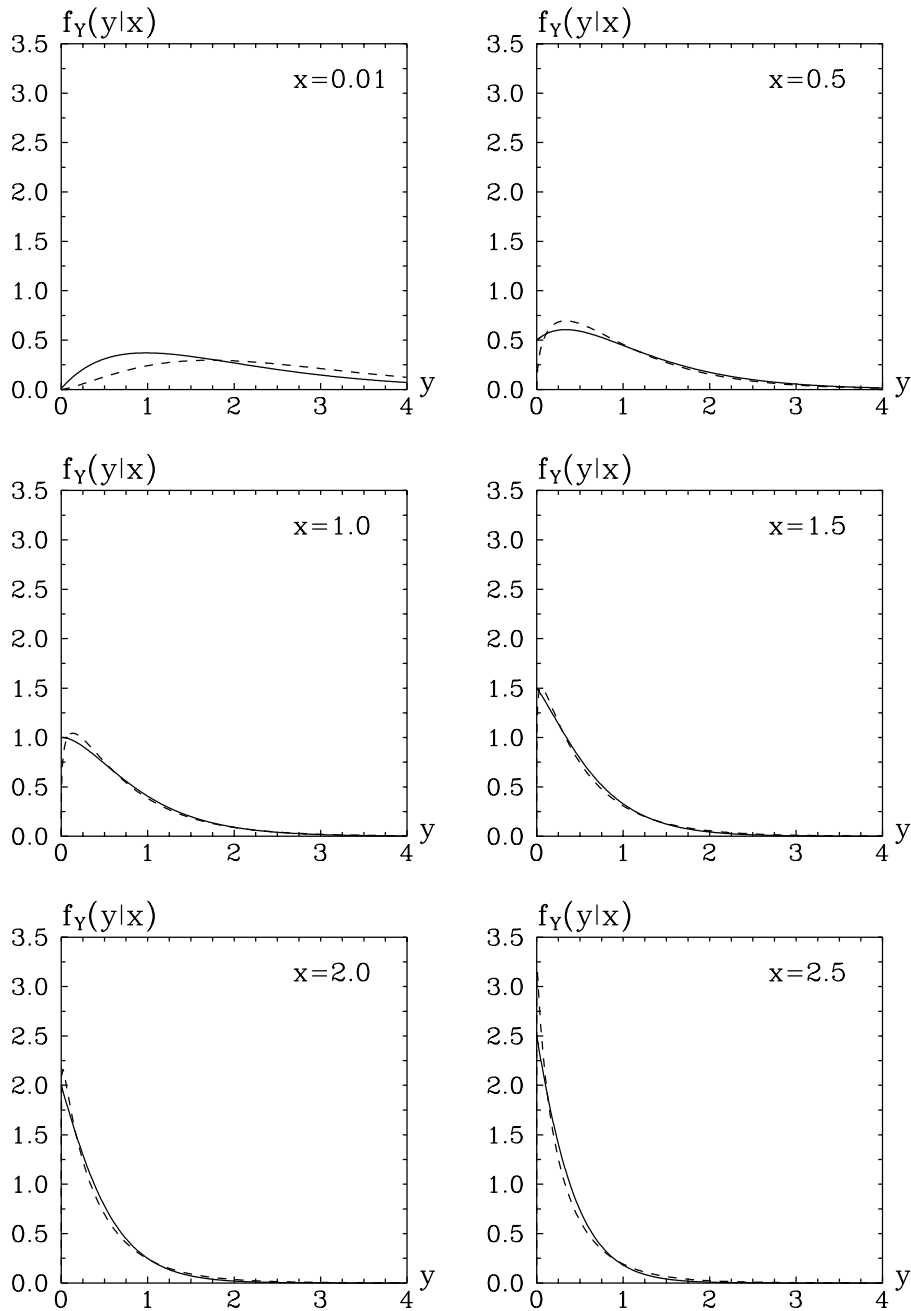

Figure 7.5: Conditional densities determined by the two-dimensional exponential distribution (7.2.41) (full curves) compared with the corresponding conditional densities from that Nataf distribution that has the same marginal distributions and correlation coefficient as the exponential distribution (dashed curves).

Nataf distribution has the density

$$f_{X,Y}(x,y) = \frac{e^{-(x+y)}}{\varphi(y_1)\varphi(y_2)} \varphi_2(y_1, y_2; \rho) \quad (7.2.49)$$

where $\rho = Rr \approx -0.556$ with the factor $R = 1.229 - 0.367r + 0.153r^2 = 1.402$ taken from Table A2.5 in Appendix 2 and

$$\begin{aligned} y_1 &= \Phi^{-1}(1 - e^{-x}) \\ y_2 &= \Phi^{-1}(1 - e^{-y}) \end{aligned} \quad (7.2.50)$$

Fig. 7.5 shows comparisons between the conditional densities $f_Y(y|x)$ for the two distributions for different values of x . \square

In practice it will most often be such that the distribution of X is not given directly by the distribution function (7.2.37), but rather by the conditional distribution functions that enter (7.2.38).

7.3 On differentiable mappings and surfaces

The theory of differentiable mappings and surfaces is assumed to be known from the mathematical analysis. We will here shortly repeat some of the most fundamental concepts and properties that we need in the following.

Let Ω be a domain in \mathbb{R}^n . The mapping $T : \mathbf{x} \in \Omega \curvearrowright \mathbf{y} \in \mathbb{R}^n$ is said to be continuously differentiable if T has continuous partial derivatives $\partial y_i / \partial x_j$ everywhere in Ω . For our purpose we only need to consider continuously differentiable mappings $\mathbf{y} = T(\mathbf{x})$ with functional matrices $\{\partial y_i / \partial x_j\}$ that are regular everywhere in Ω . Moreover we can assume that for each considered mapping T there is an inverse mapping $\mathbf{x} = T^{-1}(\mathbf{y})$ that maps any point $\mathbf{y} \in \mathbb{R}^n$ at a corresponding point $\mathbf{x} \in \Omega$. Like T itself, the inverse mapping $T^{-1} : \mathbb{R}^n \curvearrowright \Omega$ is a continuously differentiable mapping with regular functional matrix

$$\mathbf{A}_{\mathbf{x}_0} = \left\{ \frac{\partial x_i}{\partial y_j}(\mathbf{y}_0) \right\} \quad (7.3.1)$$

at any point $\mathbf{y}_0 = T(\mathbf{x}_0) \in \mathbb{R}^n$. Its inverse matrix $\mathbf{A}_{\mathbf{x}_0}^{-1}$ is the functional matrix for T at \mathbf{x}_0 . Between the differentials $d\mathbf{x}$ and $d\mathbf{y}$ considered at \mathbf{x}_0 we then have the relations

$$d\mathbf{x} = \mathbf{A}_{\mathbf{x}_0} d\mathbf{y}, \quad d\mathbf{y} = \mathbf{A}_{\mathbf{x}_0}^{-1} d\mathbf{x} \quad (7.3.2)$$

The corresponding inhomogeneous linear mapping $L_{\mathbf{x}_0} : \mathbb{R}^n \curvearrowright \mathbb{R}^n$ defined by

$$L_{\mathbf{x}_0} : \mathbf{y} = \mathbf{y}_0 + \mathbf{A}_{\mathbf{x}_0}^{-1}(\mathbf{x} - \mathbf{x}_0) \quad (7.3.3)$$

is called the tangential mapping to T at the point \mathbf{x}_0 . The inverse inhomogeneous linear mapping $L_{\mathbf{x}_0}^{-1} : \mathbb{R}^n \curvearrowright \mathbb{R}^n$ defined by

$$L_{\mathbf{x}_0}^{-1} : \mathbf{x} = \mathbf{x}_0 + \mathbf{A}_{\mathbf{x}_0}(\mathbf{y} - \mathbf{y}_0) \quad (7.3.4)$$

is the tangential mapping to T^{-1} at \mathbf{y}_0 .

A surface in \mathbf{y} -space defined by an equation of the form

$$g(\mathbf{y}) = 0 \quad (7.3.5)$$

where g is a differentiable function within its domain of definition, is said to be a differentiable surface if the vector of partial derivatives $(g_1(\mathbf{y}), \dots, g_n(\mathbf{y}))$ are different from the zero vector everywhere on the surface. If $g(\mathbf{y})$ is interpreted as a scalar field in the \mathbf{y} -space, the vector of partial derivatives is identical to the gradient vector

$$\text{grad } g = \nabla g = [g_1 \dots g_n]^T \quad (7.3.6)$$

and is orthogonal to the surface given by (7.3.5) (since $dg = g_1 dy_1 + \dots + g_n dy_n = 0$ for (dy_1, \dots, dy_n) tangential to the surface).

The continuous differentiable mapping T^{-1} maps the differentiable surface given by (7.3.5) onto a surface in the \mathbf{x} -space defined by the equation

$$G(\mathbf{x}) = 0 \quad (7.3.7)$$

where

$$G(\mathbf{x}) = g[T(\mathbf{x})] \quad (7.3.8)$$

has the continuous partial derivatives

$$G_{,i}(\mathbf{x}) = \sum_{j=1}^n g_{,j}[T(\mathbf{x})] \frac{\partial y_j}{\partial x_i}, \quad i = 1, \dots, n \quad (7.3.9)$$

From this it follows that the vector of partial derivatives can be written as

$$\nabla G(\mathbf{x}) = (\mathbf{A}_{\mathbf{x}}^{-1})^T \nabla g(\mathbf{y}) \quad (7.3.10)$$

It is seen that $\nabla G(\mathbf{x})$ is different from the zero vector if $\nabla g(\mathbf{y})$ is different from the zero vector. Thus the surface given by (7.3.7) is differentiable.

In a similar way the tangential mapping $L_{\mathbf{x}_0}^{-1}$ to T^{-1} at \mathbf{y}_0 maps the same differentiable surface given by (7.3.5) onto a differentiable surface with the equation

$$g[\mathbf{y}_0 + \mathbf{A}_{\mathbf{x}_0}^{-1}(\mathbf{x} - \mathbf{x}_0)] = 0 \quad (7.3.11)$$

where the compound function on the left hand side of the equality sign at the point \mathbf{x}_0 has the vector of partial derivatives

$$(\mathbf{A}_{\mathbf{x}_0}^{-1})^T \nabla g(\mathbf{y}_0) \quad (7.3.12)$$

Assume that \mathbf{y}_0 is a point on the surface in the \mathbf{y} -space, that is, $g(\mathbf{y}_0) = 0$. By comparison of (7.3.10) and (7.3.12) it is then seen that the two image surfaces in the \mathbf{x} -space given by (7.3.7) and (7.3.11), respectively, have a common normal vector at the common point $\mathbf{x} = T(\mathbf{y})$. Thus they touch each other tangentially at the point \mathbf{x}_0 . In particular it is so that if $g(\mathbf{y})$ is an inhomogeneous linear function of \mathbf{y} , then the surface given by $g(\mathbf{y}) = 0$ is a hyperplane in the \mathbf{y} -space while the image surface (7.3.11) by $L_{\mathbf{x}_0}^{-1}$ is a hyperplane in the \mathbf{x} -space. If $g(\mathbf{y}_0) = 0$, this hyperplane is coincident with the tangent hyperplane at \mathbf{x}_0 to the image surface by T^{-1} as given by (7.3.7).

7.4 The normal tail-approximation principle for determination of locally most central limit-state points

In this section we will characterize and determine such points on a limit-state surface in the free physical formulation space that, by the transformation $\mathbf{u} = T(\mathbf{x})$, are mapped at locally most central points on the corresponding limit-state surface in the Gaussian formulation space. For this we will use the properties of differentiable mappings and surfaces outlined in the previous section.

Let \mathcal{S}_x be a simply connected safe set in the free physical formulation space and let \mathcal{S}_x have a boundary $\partial\mathcal{S}_x$, the limit-state surface, which is a differentiable surface \mathcal{G}_x given by

$$\mathcal{G}_x = \{\mathbf{x} \mid G(\mathbf{x}) = 0\} \tag{7.4.1}$$

The transformation $T : \Omega \curvearrowright \mathbb{R}^n$ is required to be continuously differentiable and moreover to have properties as defined in the previous section. Further it is required that the transformation has such properties that it maps \mathcal{S}_x onto a simply connected set $\mathcal{S}_u = T(\mathcal{S}_x)$, the internal of \mathcal{S}_x onto the internal of \mathcal{S}_u , and the boundary $\partial\mathcal{S}_x$ onto the boundary $\partial\mathcal{S}_u = T(\partial\mathcal{S}_x)$. Then $\partial\mathcal{S}_u$ is a differentiable limit-state surface

$$\mathcal{G}_u = \{\mathbf{u} \mid g(\mathbf{u}) = 0\} \tag{7.4.2}$$

$$g(\mathbf{u}) = G[T^{-1}(\mathbf{u})] \tag{7.4.3}$$

Choose a point $\mathbf{x}_0 \in \mathcal{G}_x$. If $\mathbf{u}_0 = T(\mathbf{x}_0)$ should happen to be a locally most central point on \mathcal{G}_u , the point \mathbf{x}_0 becomes the corresponding most central point on the surface $L_{\mathbf{x}_0}^{-1}(\mathcal{G}_u)$ in the particular Gaussian space that is obtained by mapping of the standardized Gaussian space by use of the inhomogeneous linear mapping $L_{\mathbf{x}_0}^{-1}T : \mathbb{R}^n \curvearrowright \mathbb{R}^n$ as defined by (7.3.4). The corresponding Gaussian random vector is, see(7.3.1) and (7.3.4),

$$\mathbf{Z}_{\mathbf{x}_0} = \mathbf{A}_{\mathbf{x}_0} \mathbf{U} + \boldsymbol{\mu}_{\mathbf{x}_0} \tag{7.4.4}$$

$$\boldsymbol{\mu}_{\mathbf{x}_0} = \mathbf{x}_0 - \mathbf{A}_{\mathbf{x}_0} \mathbf{u}_0 \tag{7.4.5}$$

with mean value vector and covariance matrix

$$E[\mathbf{Z}_{\mathbf{x}_0}] = \boldsymbol{\mu}_{\mathbf{x}_0}, \quad \text{Cov}[\mathbf{Z}_{\mathbf{x}_0}, \mathbf{Z}_{\mathbf{x}_0}^T] = \mathbf{A}_{\mathbf{x}_0} \mathbf{A}_{\mathbf{x}_0}^T \tag{7.4.6}$$

respectively. By use of Theorem 5.1 in Section 5.3 we can then formulate the following:

Theorem 7.1 *The point $\mathbf{u}_0 = T(\mathbf{x}_0)$ is a locally most central point on \mathcal{G}_u only if*

$$\mathbf{x}_0 = \hat{E}[\mathbf{Z}_{\mathbf{x}_0} \mid M_{\mathbf{x}_0} = 0] \tag{7.4.7}$$

where $M_{\mathbf{x}_0}$ is the linear safety margin that corresponds to the tangent hyperplane to \mathcal{G}_x at \mathbf{x}_0 , however with $\mathbf{Z}_{\mathbf{x}_0}$ substituted in place of \mathbf{X} . The corresponding local geometric reliability index is

$$\beta_{\mathbf{x}_0} = \frac{E[M_{\mathbf{x}_0}]}{D[M_{\mathbf{x}_0}]} \tag{7.4.8}$$

That the definition in this theorem of the linear safety margin $M_{\mathbf{x}_0}$ can be used in (7.4.7) and (7.4.8) follows directly from the concluding remark in the previous section. This concluding remark is that the tangent hyperplane to $L_{\mathbf{x}_0}^{-1}(\mathcal{G}_u)$ at $\mathbf{x}_0 = T^{-1}(\mathbf{u}_0)$ is coincident with the tangent hyperplane to $\mathcal{G}_x = T^{-1}(\mathcal{G}_u)$ at the same point \mathbf{x}_0 .

As in Section 5.3 the condition (7.4.7) directly points at an iteration principle for the determination of locally most central points:

$$\begin{array}{l}
 \mathbf{x}_m \\
 \downarrow \\
 \text{determine } \mathbf{A}_{\mathbf{x}_m}, \boldsymbol{\mu}_{\mathbf{x}_m} \text{ and } M_{\mathbf{x}_m} = G(\mathbf{x}_m) + \nabla G(\mathbf{x}_m)^\top (\mathbf{Z}_{\mathbf{x}_m} - \mathbf{x}_m) \\
 \downarrow \\
 \text{determine } \mathbf{x}_{m+1} = \hat{E}[\mathbf{Z}_{\mathbf{x}_m} \mid M_{\mathbf{x}_m} = 0]
 \end{array} \tag{7.4.9}$$

If a sequence of points $\mathbf{x}_1, \mathbf{x}_2, \dots, \mathbf{x}_m, \dots$ determined in this way is convergent with \mathbf{x}^* as limit point, then $\mathbf{x}^* \in \mathcal{G}_x$ and $\mathbf{u}^* = T(\mathbf{x}^*)$ is possibly a locally most central point on \mathcal{G}_u . The proof of this is the same as in Section 5.3. The limit safety margin $M_{\mathbf{x}^*}$ corresponding to \mathbf{x}^* determines the local geometric reliability index in the usual way as the simple reliability index.

Example 7.7 For the first of the two Rosenblatt transformations in Example 7.5 we will determine the locally most central points on the line piece that connects the points (0, 9) and (6, 0) in the (x, y) -space. The mapping (7.2.45) has the functional matrix

$$\mathbf{A}^{-1} = \left\{ \frac{\partial u_i}{\partial x_j} \right\} = \begin{bmatrix} \frac{1}{\varphi(u_1)} e^{-x} & 0 \\ \frac{1}{\varphi(u_2)} y(1+y) e^{-(1+x)y} & \frac{1}{\varphi(u_2)} [(1+x)(1+y) - 1] e^{-(1+x)y} \end{bmatrix} \tag{7.4.10}$$

from which it follows that the inverse mapping has the functional matrix

$$\mathbf{A} = \left\{ \frac{\partial x_i}{\partial u_j} \right\} = \begin{bmatrix} \varphi(u_1) e^x & 0 \\ \varphi(u_1) \frac{-y(1+y) e^x}{(1+x)(1+y) - 1} & \varphi(u_2) \frac{e^{(1+x)y}}{(1+x)(1+y) - 1} \end{bmatrix} \tag{7.4.11}$$

Omitting the subscripts, (7.4.5) and (7.4.6) give

$$E[\mathbf{Z}] = \mathbf{x} - \mathbf{A}\mathbf{u} = \begin{bmatrix} x - u_1 \varphi(u_1) e^x \\ y + \frac{u_1 \varphi(u_1) y(1+x) e^x - u_2 \varphi(u_2) e^{(1+x)y}}{(1+x)(1+y) - 1} \end{bmatrix} \tag{7.4.12}$$

$$\text{Cov}[\mathbf{Z}, \mathbf{Z}^\top] = \mathbf{A}\mathbf{A}^\top = \varphi(u_1)^2 e^{2x} \begin{bmatrix} 1 & \frac{-y(1+x)}{(1+x)(1+y) - 1} \\ \frac{-y(1+x)}{(1+x)(1+y) - 1} & \frac{y^2(1+x)^2 + e^{2(y+xy-x)} + u_1^2 - u_2^2}{[(1+x)(1+y) - 1]^2} \end{bmatrix} \tag{7.4.13}$$

Since $G(x) = -3x - 2y + 18$ is linear in (x, y) , we have directly that $M = 18 - [3 \ 2]\mathbf{Z}$ for any approximation point. The linear regression of \mathbf{Z} on $M = 0$ becomes, see (4.4.3),

$$\hat{E}[\mathbf{Z} | M = 0] = E[\mathbf{Z}] + \frac{\mathbf{A}\mathbf{A}^T \begin{bmatrix} 3 \\ 2 \end{bmatrix}}{[3 \ 2]\mathbf{A}\mathbf{A}^T \begin{bmatrix} 3 \\ 2 \end{bmatrix}} (18 - [3 \ 2] E[\mathbf{Z}]) \quad (7.4.14)$$

and the reliability index corresponding to M becomes

$$\beta = \frac{18 - [3 \ 2] E[\mathbf{Z}]}{\sqrt{[3 \ 2]\mathbf{A}\mathbf{A}^T \begin{bmatrix} 3 \\ 2 \end{bmatrix}}} \quad (7.4.15)$$

Along the straight line piece the density (7.2.44) takes its smallest value for $x = 17/6$ and local maxima for $x = 0$ and $x = 6$. It is therefore a reasonable strategy to look for two locally most central points that correspond to a point close to $(0, 9)$ and a point close to $(6, 0)$, respectively, on the straight line piece. Moreover Fig. 7.2 shows directly that there is just two locally most central points on the image curve corresponding to the straight line piece.

With start at $(x, y) = (0.050, 8.925)$ we get the following sequence of values of $\hat{E}[Z | M = 0]$ and β using as a new point of start in each step the average of the old point of start and the point determined by (7.4.14):

x	0.050	0.0965	0.1038	0.1023
y	8.925	8.8552	8.8443	8.8466
β	3.4345	3.5006	3.5012	$3.5012 \approx \beta_2$

This gives $\Phi(-\beta_2) \approx 0.232 \times 10^{-3}$. With start at $(x, y) = (5.959, 0.075)$ we get in the same way the following sequence:

x	5.950	5.9365	5.9273	5.9217	5.9186
y	0.075	0.0953	0.1090	0.1174	0.1222
β	2.7855	2.7842	2.7838	2.7836	$2.7835 \approx \beta_1$

which gives $\Phi(-\beta_1) \approx 2.689 \times 10^{-3}$. The corresponding locally most central points are directly identified on the curves in Fig. 7.4. The single point FORM-approximation to the probability $P(3X + 2Y > 18)$ thus is 2.69×10^{-3} .

For the Rosenblatt transformation appearing for the other possible ordering (y, x) the following results are obtained: $(x, y) = (0.091, 8.863)$; $\beta_2 = 3.633$ and $(x, y) = (5.907, 0.140)$; $\beta_1 = 2.649$. The two points correspond to the two locally most central points on the line piece. It is noted that the points are different from the points obtained for the first ordering. The probability approximations are $\Phi(-\beta_2) \approx 0.140 \times 10^{-3}$ and $\Phi(-\beta_1) \approx 4.037 \times 10^{-3}$, respectively. In this case the single point FORM-approximation thus gives 4.04×10^{-3} , that is, a result which is larger than the result obtained by the ordering (x, y) . This difference is essentially due to the different curvatures of the limit state

curve at the most central points. For the ordering (x, y) the curvature is small and positive while for the ordering (y, x) it is numerically considerably larger and negative, Fig. 7.4 and Table 7.3.

At each of the points the curvature κ can be calculated by use of (6.4.20) such that the curvature correction factor in (6.4.10) can be obtained. We find the results shown in Table 7.3. It is seen that the two single point SORM-approximations to the probability differ by about 1% and also that the FORM-approximation corresponding to the ordering (x, y) is accurate.

ordering	β	$10^3\Phi(-\beta)$	κ	$\frac{10^3\Phi(-\beta)}{\sqrt{1-\kappa\beta}}$	β_G
(x, y)	2.784	2.689	0.0249	2.783	2.772
(x, y)	3.501	0.232	-0.4163	0.148	3.619
sum:	-	2.921	-	2.931	2.755
(y, x)	2.649	4.037	-0.4003	2.812	2.769
(y, x)	3.633	0.140	0.0305	0.148	3.618
sum:	-	4.177	-	2.960	2.752

Table 7.3: Results of asymptotic SORM-calculation of the probability $P(3X + 2Y > 18)$ in Example 7.7 by use of the two Rosenblatt transformations that correspond to the orderings (x, y) and (y, x) , respectively. The sums are used in Example 7.9.

□

Remark 7.1 It is emphasized that Theorem 7.1 is also valid when the transformation T maps into a Gaussian space which is not standardized. For example, this is relevant when using Nataf's distribution model in which the transformation is defined by (7.2.1), that is, solely on the basis of the one-dimensional marginal distributions of X_1, \dots, X_n , also when these variables are correlated. Then we just have that the covariance matrix for $\mathbf{Z}_{\mathbf{x}_0}$ becomes, see (7.4.4),

$$\text{Cov}[\mathbf{Z}_{\mathbf{x}_0}, \mathbf{Z}_{\mathbf{x}_0}^T] = \mathbf{A}_{\mathbf{x}_0} \text{Cov}[\mathbf{Y}, \mathbf{Y}^T] \mathbf{A}_{\mathbf{x}_0}^T \quad (7.4.16)$$

□

Example 7.8 We will solve the same problem as in Example 7.7, but under the assumption that (X, Y) has the Nataf distribution (7.2.49). The functional matrix corresponding to the marginal transformation (7.2.50) is the diagonal matrix

$$\mathbf{A}^{-1} = [e^{-x}/\varphi(y_1) \quad e^{-y}/\varphi(y_2)] \quad (7.4.17)$$

such that

$$E[\mathbf{Z}] = \mathbf{x} - \mathbf{A}\mathbf{y} = \begin{bmatrix} x - y_1\varphi(y_1)e^x \\ y - y_2\varphi(y_2)e^y \end{bmatrix} \quad (7.4.18)$$

and, see (7.4.16),

$$\text{Cov}[\mathbf{Z}, \mathbf{Z}^T] = \mathbf{A} \begin{bmatrix} 1 & \rho \\ \rho & 1 \end{bmatrix} \mathbf{A}^T = \begin{bmatrix} \varphi(y_1)^2 e^{2x} & \rho\varphi(y_1)\varphi(y_2)e^{x+y} \\ \rho\varphi(y_1)\varphi(y_2)e^{x+y} & \varphi(y_2)^2 e^{2y} \end{bmatrix} \quad (7.4.19)$$

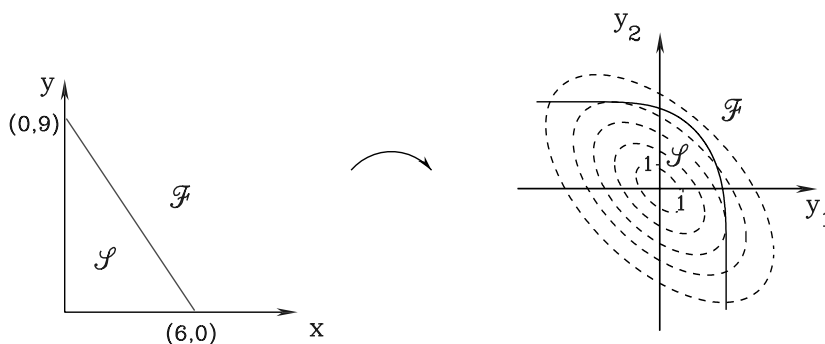

Figure 7.6: The Nataf transformation (Examples 7.6 and 7.8).

where $\rho = -0.566$. The formulas (7.4.14) and (7.4.15) are valid after replacement of $\mathbf{A}\mathbf{A}^T$ by $\text{Cov}[\mathbf{Z}, \mathbf{Z}^T]$. With judgementsly chosen start points for the iterations we get the following sequences:

x	0.050	0.0356	0.0300	0.0273	0.0260
y	8.925	8.9466	8.9551	8.9590	8.9611
β	3.6596	3.6575	3.6570	3.6569	$3.6568 \approx \beta_2$

for which $\Phi(-\beta_2) \approx 1.277 \times 10^{-4}$, and

x	5.900	5.9310	5.9426	5.9478	5.9505
y	0.150	0.1035	0.0861	0.0783	0.0743
β	2.8008	2.7968	2.7959	2.7957	$2.7957 \approx \beta_1$

for which $\Phi(-\beta_2) \approx 2.589 \times 10^{-3}$.

Fig. 7.6 shows the image of the straight-line piece by the marginal transformation as well as some few curves of constant density of the normal distribution of mean values (0,0), variances (1,1) and correlation coefficient $\rho = -0.556$. A locally most central point of the image curve is characterized by the property that the image curve and a curve of constant density are tangential to each other at the point. □

Remark 7.2 If several points $\mathbf{x}_1, \dots, \mathbf{x}_q \in \mathcal{G}_x$ are determined as points that are mapped at locally most central points on \mathcal{G}_u we may, of course, calculate an approximation to the generalized reliability index by use of multipoint FORM. The joint set of linear safety margins $M_{\mathbf{x}_1}, \dots, M_{\mathbf{x}_q}$ considered as functions of $\mathbf{Z}_{\mathbf{x}_1}, \dots, \mathbf{Z}_{\mathbf{x}_q}$ respectively, define a q -sided convex polyhedral set in the standardized Gaussian space (the \mathbf{u} -space). This polyhedral set approximates \mathcal{S}_u . However, the calculation of the approximation to the probability on \mathcal{S}_u can be made directly by use of the safety margins $M_{\mathbf{x}_1}, \dots, M_{\mathbf{x}_q}$. Their joint q -dimensional distribution is Gaussian with mean values

$$E[M_{\mathbf{x}_i}] = \beta_i D[M_{\mathbf{x}_i}] \tag{7.4.20}$$

and covariances $\text{Cov}[M_{\mathbf{x}_i}, M_{\mathbf{x}_j}]$ determined by use of the covariances

$$\text{Cov}[\mathbf{Z}_{\mathbf{x}_i}, \mathbf{Z}_{\mathbf{x}_j}^T] = \mathbf{A}_{\mathbf{x}_i} \mathbf{A}_{\mathbf{x}_j}^T \tag{7.4.21}$$

Thus we are back in the type of problem described in Section 6.3.

Also single-point multiple FORM, Section 6.6, can be handled as in Section 5.3 after a direct generalization of Theorem 7.1 such that the condition (7.4.7) gets the form as (5.3.24). \square

Example 7.9 In the problem of Example 7.7 we obtained two points x and y that are mapped at locally most central points on the limit-state curve in the standardized Gaussian space. Then we have

$$\begin{aligned} \text{Cov}[\mathbf{Z}_{x_1}, \mathbf{Z}_{x_2}^\top] &= \mathbf{A}_{x_1} \mathbf{A}_{x_2}^\top = \begin{bmatrix} 3.0849 & 0.0000 \\ -0.0625 & 0.1372 \end{bmatrix} \begin{bmatrix} 0.1905 & -1.6837 \\ 0.0000 & 3.5156 \end{bmatrix} \\ &= \begin{bmatrix} 0.5872 & -5.1902 \\ -0.0919 & 0.5876 \end{bmatrix} \end{aligned} \quad (7.4.22)$$

and thus

$$\text{Cov}[M_{x_1}, M_{x_2}] = \begin{bmatrix} 3 & 2 \end{bmatrix} \mathbf{A}_{x_1} \mathbf{A}_{x_2}^\top \begin{bmatrix} 3 \\ 2 \end{bmatrix} = -23.58 \quad (7.4.23)$$

$$\text{Var}[M_{x_1}] = \begin{bmatrix} 3 & 2 \end{bmatrix} \mathbf{A}_{x_1} \mathbf{A}_{x_1}^\top \begin{bmatrix} 3 \\ 2 \end{bmatrix} = 83.30 \quad (7.4.24)$$

$$\text{Var}[M_{x_2}] = \begin{bmatrix} 3 & 2 \end{bmatrix} \mathbf{A}_{x_2} \mathbf{A}_{x_2}^\top \begin{bmatrix} 3 \\ 2 \end{bmatrix} = 57.25 \quad (7.4.25)$$

so that

$$\text{Corr}[M_{x_1}, M_{x_2}] = -0.341 \quad (7.4.26)$$

The negative correlation coefficient implies that $\Phi_2(-\beta_1, -\beta_2; \rho) \approx 2 \cdot 10^{-9}$ is negligible compared to $\Phi(-\beta_1) = 2.689 \cdot 10^{-3}$ and $\Phi(-\beta_2) = 0.232 \cdot 10^{-3}$.

Thus we find by two-point FORM that

$$P(3X + 2Y \geq 18) \approx \Phi(-\beta_1) + \Phi(-\beta_2) - \Phi_2(-\beta_1, -\beta_2; \rho) \approx 2.921 \cdot 10^{-3} \quad (7.4.27)$$

This result corresponds to the ordering (x, y) while the ordering (y, x) gives the two-point FORM-approximation 4.177×10^{-3} , Table 7.3, where the last result is about 43% larger than the first. For the two orderings the two-point SORM-approximation becomes 2.931×10^{-3} and 2.960×10^{-3} , respectively, Table 7.3, results that only differ by about 0.3%. The corresponding generalized reliability indices are $\beta_G = 2.755$ and 2.752 .

For the Nataf distribution considered in Example 7.8 the correlation coefficient between the two safety margins is about 0.1 and two-point FORM gives that

$$P(3X + 2Y \geq 18) \approx (2.589 + 0.128 - 0.000) \cdot 10^{-3} \approx 2.72 \cdot 10^{-3} \quad (7.4.28)$$

which corresponds to the generalized reliability index $\beta_G = 2.780$. The replacement of the two-dimensional exponential distribution in Example 7.5 by the corresponding Nataf distribution in Example 7.6 is seen to lead to an almost unchanged generalized reliability index. \square

It is seen that the described method for determination of locally most central points on \mathcal{G}_u followed by application of multipoint FORM formally looks as if the distribution for X is approximated by different normal distributions at certain points of \mathcal{G}_x . Therefore the method has been called “the normal tail-approximation principle”. The reason for this terminology becomes even more clear in the following example. In spite of the name the method is exact with respect to the determination of locally most central limit state points.

Example 7.10 If the transformation T is the simple marginal transformation defined by (7.2.1), the matrix \mathbf{A}_x in (7.3.1) becomes a diagonal matrix in which the i th diagonal element $\sigma_i = \partial x_i / \partial y_i$ is determined by differentiation of the equation (7.2.1). We get

$$\varphi(y_i) = f_i(x_i)\sigma_i \tag{7.4.29}$$

where $f_i(x_i) = F'_i(x_i)$ is the density function corresponding to F_i . The i th element in $\boldsymbol{\mu}_x$ as defined by (7.4.5) then becomes

$$\mu_i = x_i - \sigma_i y_i \tag{7.4.30}$$

from which

$$y_i = \frac{x_i - \mu_i}{\sigma_i} \tag{7.4.31}$$

By substitution of this formula into (7.2.1) and into (7.4.29) we get the equations

$$\Phi\left(\frac{x_i - \mu_i}{\sigma_i}\right) = F_i(x_i) \tag{7.4.32}$$

$$\frac{1}{\sigma_i} \varphi\left(\frac{x_i - \mu_i}{\sigma_i}\right) = f_i(x_i) \tag{7.4.33}$$

from which μ_i and σ_i can be determined for any choice of $\mathbf{x} = \mathbf{x}_0$. The equations determine the mean value μ_i and the standard deviation σ_i in the normal distribution that has the same distribution function value and the same density function value at the approximation point \mathbf{x}_0 as the given distribution of the input variable X_i . □

Remark 7.3 The possibilities to construct a sufficiently good convex polyhedral approximation to the safe set in a Gaussian formulation space depends not just on the shape of the safe set in the free physical formulation space but also on the properties of the transformation T .

Consider the following example. Let (X, Y) be uniformly distributed on the internal of the circle with center at the origin and radius 1. Then the pair

$$(U_1, U_2) = 2 \frac{\sqrt{-\log R}}{R} (X, Y) \tag{7.4.34}$$

with R defined by

$$R = \sqrt{X^2 + Y^2} \tag{7.4.35}$$

has a rotation symmetric density that by elementary calculations can be shown to be standardized Gaussian. If it is assumed that the safe set is a circle with center at the origin and radius $r < 1$, the image of the safe set is the set of points outside the circle with center at the origin and radius $2\sqrt{-\log r}$. Thus the safe set does even not contain the central part of the standardized normal distribution and an approximation of the safe set by a convex polyhedral set is out of the question.

Except for the fact that this example is so simple that a transformation is not necessary, the same example can be used to illustrate that the Rosenblatt transformation (7.2.41) is not necessarily the simplest choice of transformation. In this example it is much simpler to transform (X, Y) into the pair (R, Θ) of polar coordinates to (X, Y) . Then R and Θ are mutually independent, R has a density proportional to r , and Θ is uniformly distributed on the interval $[0, 2\pi]$. The simple marginal transformation (7.2.1) can then be applied to (R, Θ) . \square

7.5 Approximate calculation of values of the multi-dimensional normal distribution function by use of FORM and SORM*

Let \mathbf{M} be a Gaussian random vector of safety margins defined such that all variances are 1 and let \mathbf{M} have the correlation matrix \mathbf{P}_M . In this section we will demonstrate an approximative method based on FORM or SORM for the calculation of the probability

$$P(\mathbf{M} > \mathbf{0}) = \Phi_m(\boldsymbol{\beta}; \mathbf{P}_M) \quad (7.5.1)$$

where Φ_m is the distribution function for the m -dimensional normal distribution and $\boldsymbol{\beta}$ is the vector of simple reliability indices $\beta_i = E[M_i]/D[M_i]$ corresponding to the elements M_1, \dots, M_m in \mathbf{M} .

First step consists in decomposing \mathbf{P}_M into a product

$$\mathbf{P}_M = \mathbf{A}\mathbf{A}^T \quad (7.5.2)$$

where \mathbf{A} is a lower triangular matrix with the first diagonal element $a_{11} = 1$. This can be made by the Choleski triangulation method. We have then that \mathbf{M} can be written

$$\mathbf{M} = \mathbf{A}\mathbf{U} + \boldsymbol{\beta} \quad (7.5.3)$$

where $\mathbf{U} = (U_1, \dots, U_m)$ is a standardized Gaussian random vector. This is shown by noting that (7.5.3) is an inhomogeneous linear transformation that maps \mathbf{U} into \mathbf{M} such that $\text{Cov}[\mathbf{M}, \mathbf{M}^T] = \text{Cov}[\mathbf{A}\mathbf{U}, \mathbf{U}^T \mathbf{A}^T] = \mathbf{A}\text{Cov}[\mathbf{U}, \mathbf{U}^T] \mathbf{A}^T = \mathbf{A}\mathbf{I}\mathbf{A}^T = \mathbf{P}_M$ according to (7.5.2), and $E[\mathbf{M}] = \mathbf{A}E[\mathbf{U}] + \boldsymbol{\beta} = \boldsymbol{\beta}$.

We can then write (7.5.1) as

$$P(\mathbf{M} > \mathbf{0}) = P(\mathbf{A}\mathbf{U} > -\boldsymbol{\beta}) = P(\mathbf{A}\mathbf{U} < \boldsymbol{\beta}) = P(\mathbf{A}\mathbf{U} < \boldsymbol{\beta} | U_1 < \beta_1) \Phi(\beta_1) \quad (7.5.4)$$

Since U_1, \dots, U_m are mutually independent, only U_1 in the event $\{\mathbf{A}\mathbf{U} < \boldsymbol{\beta}\}$ is affected by the condition $U_1 < \beta_1$. We have

$$P(U_1 \leq u_1 | U_1 < \beta_1) = \begin{cases} \frac{\Phi(u_1)}{\Phi(\beta_1)} & \text{for } u_1 \leq \beta_1 \\ 1 & \text{for } u_1 > \beta_1 \end{cases} \quad (7.5.5)$$

The calculation of the conditional probability $P(\mathbf{AU} < \boldsymbol{\beta} | U_1 < \beta_1)$ is hereby transformed to a space which is standardized Gaussian in all variables except the first variable. In this space the event $\{\mathbf{AU} < \boldsymbol{\beta} | U_1 < \beta_1\}$ is defined by the $m - 1$ inequalities

$$\mathbf{A}_1 \mathbf{U} < \boldsymbol{\beta}_1 \quad (7.5.6)$$

where \mathbf{A}_1 and $\boldsymbol{\beta}_1$ are submatrices of \mathbf{A} and $\boldsymbol{\beta}$ defined as follows:

$$\mathbf{A} = \begin{bmatrix} 1 & 0 & 0 & \dots & 0 \\ & & \mathbf{A}_1 & & \end{bmatrix} = \begin{bmatrix} 1 & \mathbf{0} \\ \boldsymbol{\alpha}_1 & \mathbf{A}_{11} \end{bmatrix}, \quad \boldsymbol{\beta} = \begin{bmatrix} \beta_1 \\ \boldsymbol{\beta}_1 \end{bmatrix} \quad (7.5.7)$$

The one-to-one mapping

$$\mathbf{U} \in (-\infty, \beta_1] \times \mathbb{R}^{m-1} \rightsquigarrow \mathbf{Y} \in \mathbb{R}^m \quad (7.5.8)$$

$$\Phi(Y_1) = \frac{\Phi(U_1)}{\Phi(\beta_1)} \quad (7.5.9)$$

$$Y_i = U_i \quad \text{for } i = 2, \dots, m \quad (7.5.10)$$

defines a standardized Gaussian vector (Y_1, \dots, Y_m) and in the corresponding Gaussian space the conditional event $\{\mathbf{AU} < \boldsymbol{\beta} | U_1 < \beta_1\}$ is represented by the event

$$\{\boldsymbol{\alpha}_1 \Phi^{-1}[\Phi(\beta_1)\Phi(Y_1)] + \mathbf{A}_{11} \mathbf{Y}_1 < \boldsymbol{\beta}_1\} \quad (7.5.11)$$

where $\boldsymbol{\alpha}_1$ and \mathbf{A}_{11} are defined in (7.5.7) as submatrices of \mathbf{A}_1 . The event (7.5.11) is by the intersection of the $m - 1$ marginal events defined by the $m - 1$ inequalities in (7.5.11).

The event (7.5.11) is next approximated by a convex polyhedral set of $m - 1$ faces. Each of the $m - 1$ marginal limit-state surfaces in (7.5.11) is replaced by a hyperplane following the principles of FORM or SORM. It is noted that the probability of the i th marginal event in (7.5.11) is calculated solely by use of the fact that the two random variables Y_1 and

$$Z_i = \alpha_{i+1,2} U_2 + \dots + \alpha_{i+1,i+1} U_{i+1} \quad (7.5.12)$$

are Gaussian and mutually independent with the mean values zero and the variances 1 and $a_{i+1,2}^2 + \dots + a_{i+1,i+1}^2$, respectively.

In stead of fixing the approximating hyperplane as a plane parallel to the tangent hyperplane at the most central point of the i th limit-state surface in (7.5.11), the plane can be chosen as a so-called "equivalent" hyperplane. The normal vector to this hyperplane is defined to be parallel to the direction of largest velocity of increase of the probability when the limit-state surface is parallel shifted by a given direction independent velocity in the considered direction.

The result of this convex polyhedral approximation with $m - 1$ hyperplanes is that the conditional probability $P(\mathbf{AU} < \boldsymbol{\beta} | U_1 < \beta_1)$ in (7.5.4) is replaced by the unconditional probability

$$P(\mathbf{N} > \mathbf{0}) = \Phi_{m-1}(\boldsymbol{\delta}; \mathbf{P}_N) \quad (7.5.13)$$

where $\delta_i = E[N_i]/D[N_i]$ and $\mathbf{N} = (N_1, \dots, N_{m-1})$ is a vector of linear safety margins that correspond to the $m - 1$ faces of the approximating polyhedral set. Thus we have derived the approximation formula

$$\Phi_m(\boldsymbol{\beta}; \mathbf{P}_M) \approx \Phi(\beta_1)\Phi_{m-1}(\boldsymbol{\delta}; \mathbf{P}_N) \quad (7.5.14)$$

by which the dimension is reduced by 1.

Due to the increasing accuracy of FORM or SORM with increasing geometric reliability index this successive dimension reduction method shows increasing accuracy for increasing value of $\min\{|\beta_1|, \dots, |\beta_m|\}$.

7.6 Reliability analysis for limit states of high complexity

Response-surface method

The practicability of structural reliability analyses methods for a specific limit state depends to a great extent on the complexity of the formulation of the limit state. Often the limit-state function $g(x_1, \dots, x_n)$ is not available in explicit form but rather defined implicitly through a complicated numerical procedure, for example given by an elaborate finite element program. For such limit-state formulations the calculations needed for the direct application of the iteration algorithm given in (7.4.9), or for similar iteration algorithms, may require very large and even prohibitive computer efforts.

One way to solve this problem of complexity is to approximate the limit-state surface in a numerical-experimental way by a surface of an explicit mathematical form as, for example, an algebraic surface of the second degree. The method is in its principle similar to the method of the experimentalist in the laboratory. A suitable family of mathematical functions is chosen such that each member of the family is uniquely fixed by the assignment of values to a finite set of free parameters. If there are m free parameters, it usually takes m different experiments to fix the surface. However, with only m experiments no information is obtained about the error of fit and the possible random error. Therefore the experimentalist will usually make more than m experiments. Thereafter the parameters are chosen by some regression method based on a suitable principle of minimization of the totality of misfit errors. A standard method is the method of least sum of suitably weighted squared errors. Exactly the same procedure is applied in numerical experimentation on the computer to obtain an approximation to the limit-state surface by regression. Such an approximation is called a *response surface* in the reliability literature. The deviation of the computed results from the response surface are easily appreciated as being misfit errors. However, also the concept of random error makes sense if the regression equation contains fewer basic variables than the elaborate model. The more important variables may be included in the simplified response-surface model while the rest of the basic variables are neglected. In the numerical experiments the values of these neglected variables may be chosen at random in accordance with their specified probability distributions, that is, they may be chosen by simulation, see Chapter 9. Thus the resulting regression error will be a sum of a misfit error (idealization error) and a random error. In accordance with the philosophy of Section 3.3 the total error is modeled by a probability distribution coming out of the statistical regression analysis. Thereafter the error variable is included in the response-surface limit-state model as an extra variable that takes care of the model uncertainty. This topic is elaborated in detail for a special important case in Section 11.4.

Once the response surface has been obtained the reliability analysis is made with the response surface as limit-state surface in place of the complicated limit-state surface of the elaborate model.

One problem with this purely experimental response-surface approximation technique is that in general it is necessary to know in advance where on the complicated limit-state surface to make the replacement by the response surface. Otherwise an iterative search procedure with determination of a new response surface in each step is needed. For problems with several variables such an iteration algorithm may require large computer efforts due to the large number of calls to the complicated numerical limit-state model needed to obtain the response surface in each step. Moreover, there is no guarantee that convergence is achieved. The response surface as shaped arbitrarily, for example by a second degree polynomial, naturally carries no obvious formal resemblance to the mechanical modeling of the complicated limit-state surface.

Therefore it would be desirable instead to be able to formulate response surfaces that come out of direct idealizations of the complicated mechanical model. Obviously it is an advancement of the understanding of the most important structural features with respect to carrying capacity if the limit states even in the most idealized form are deduced from clear and reasonably simple mechanical principles. Such properties decrease the risk of making radical design errors caused by misconception of the way the structure carries its loads when coming close to the failure situation.

For example, for structures with ductile behavior before approaching the collapse, the theory of rigid-ideal plastic structures is an idealized (and consistent) model universe that to the first approximation satisfies both geometric and statical conditions valid for the real structure. Within the realm of the ideal plasticity model the limit state can be formulated in a clear way for a large set of structure types. Usually the mathematical form of the limit state is well suited for manageable reliability analysis with respect to plastic collapse.

With the supposition that the rigid-ideal plastic theory is used as the analysis tool for the determination of the limit state, it is necessary to correct for the error of idealization when this analysis tool is applied to real structures. The considerations should be about the influence of the deviations between the ideal and the realistic constitutive relations concerning the ductile behavior. Also, the importance of deviations from genuine ductility should be judged. For example such a deviation could be limited rotation capacity of the possible yield hinges. Secondary internal forces that are due to the displacements of the real structure before collapse (i.e. geometric nonlinearities) may also affect the limit state essentially.

Based on the physical principles of dimension homogeneity in combination with the principles of first-order reliability analysis (FORM) it will be shown in the following that it is possible in a systematic way to replace a complicated limit-state reliability analysis by a simpler limit-state reliability analysis that is approximately equivalent with respect to the failure probability. It is required, though, that the safe sets of both limit-state problems with respect to the origin of the load vector are star-shaped in terms of the load vector. The purpose of this requirement is simply to ensure that any point of the safe set can be reached through proportional loading such that the entire loading path is completely contained in the safe set (that is, failure does not occur during the load growth from zero to the final value of the load). Under this star-shape condition, the strength parameters of the simple model can be corrected by a single model-correction factor (effectivity factor). The principles of FORM indicate that it may be sufficient in most cases to approximate the correction factor to the zeroth order simply by a constant, or to the first order by an inhomogeneous linear function of the set of random variables that appears in the elaborate model. This inhomogeneous linear function is determined through a specific number of particularly chosen deterministic

calculations in the elaborate model. The choice of these calculation cases is determined by the FORM analysis of the uncorrected simple model.

The method is a type of response-surface method in which the mathematical form of the response-surface equation is chosen not arbitrarily as a second degree surface but by a simple systematic correction of a mechanically interpretable, but perhaps over-idealized, limit-state equation.

Model-correction-factor method based on FORM*

For a given structure let \mathbf{x}_F be the vector of all basic variables with physical units that contain the unit of force (forces, moments, stresses, coefficients of elasticity, etc.) and let \mathbf{x}_D be the vector of all the remaining basic variables (of the type of geometric and dimensionless basic variables). With sufficient generality we can assume that the basic variables are defined such that the units of the elements in \mathbf{x}_F are proportional to the force unit. Let $\mathbf{x}_F = (\mathbf{x}_S, \mathbf{x}_R)$ be split into the vector \mathbf{x}_S of load variables and the vector \mathbf{x}_R of strength variables, respectively, and consider two limit-state equations between the vectors \mathbf{x}_S , \mathbf{x}_R , and \mathbf{x}_D to be one defined by an elaborate model, and the other by a simple model formulated to be an idealization of the elaborate model.

The input values are assumed to be specified as random variables $(\mathbf{X}_S, \mathbf{X}_R, \mathbf{X}_D)$ with a given joint probability distribution. The quantity of interest is the probability that an outcome of $(\mathbf{X}_S, \mathbf{X}_R, \mathbf{X}_D)$ is obtained in the failure set \mathcal{F}_r of the elaborate model (index r for “realistic”). The problem at hand is that the calculation of this probability $P(\mathcal{F}_r)$ is elaborate. Therefore it is attractive to try to take advantage of the simple model by which the probability $P(\mathcal{F}_i)$ of getting an outcome in the idealized failure set \mathcal{F}_i can be calculated with less effort than required for the calculation of $P(\mathcal{F}_r)$.

The two limit-state equations are formally

$$g_r(\mathbf{x}_S, \mathbf{x}_R, \mathbf{x}_D) = 0 \quad (7.6.1)$$

$$g_i(\mathbf{x}_S, \mathbf{x}_R, \mathbf{x}_D) = 0 \quad (7.6.2)$$

where g_r is a suitably regular function that is not necessarily given in explicit form, and g_i is a less elaborate function than g_r . For example, g_r could be defined implicitly through a finite-element algorithm.

It is assumed that both the safe sets are star-shaped in terms of \mathbf{x}_S with respect to the origin of \mathbf{x}_S , that is, for any $(\mathbf{x}_S, \mathbf{x}_R, \mathbf{x}_D)$ each of the following equations

$$g_r(\kappa_r \mathbf{x}_S, \mathbf{x}_R, \mathbf{x}_D) = 0 \quad (7.6.3)$$

$$g_i(\kappa_i \mathbf{x}_S, \mathbf{x}_R, \mathbf{x}_D) = 0 \quad (7.6.4)$$

has a unique solution with respect to κ_r and κ_i , respectively. As we shall see it is then a consequence of the physical property of dimension homogeneity of the limit state equations (7.6.1) and (7.6.2) that the limit state defined by the elaborate equation (7.6.1) is identical to the limit state defined by the equation

$$g_i(\mathbf{x}_S, \nu(\mathbf{x})\mathbf{x}_R, \mathbf{x}_D) = 0 \quad (7.6.5)$$

in which $v(\mathbf{x})$ is the function defined by

$$v(\mathbf{x}) = \frac{\kappa_r(\mathbf{x})}{\kappa_i(\mathbf{x})}, \quad \mathbf{x} = (\mathbf{x}_S, \mathbf{x}_R, \mathbf{x}_D) \quad (7.6.6)$$

with κ_r and κ_i being the unique solutions to (7.6.3) and (7.6.4), respectively; $v(\mathbf{x})$ is called the effectivity factor.

Proof Consider any physically admissible limit state in the space of $\mathbf{x} = (\mathbf{x}_F, \mathbf{x}_D)$. Let $g(\mathbf{x}) = 0$ be the equation of the limit state. In order for the limit state to be physically admissible, the limit-state equation must have the property that

$$g(a\mathbf{x}_F, \mathbf{x}_D) = 0 \quad \text{for all dimensionless } a > 0 \quad (7.6.7)$$

because otherwise the equation is not homogeneous with respect to the physical dimension of force. Since (7.6.7) is valid with an individual value of $a > 0$ for any specific value set of $(\mathbf{x}_F, \mathbf{x}_D)$, we can further conclude that (7.6.7) is valid if $a = a(\mathbf{x}_F, \mathbf{x}_D)$ is any everywhere positive dimensionless function of $(\mathbf{x}_F, \mathbf{x}_D)$. Consequently the dimension homogeneity of g_i allows a reformulation of the identity (7.6.4) to the following identity

$$g_i(\kappa_r(\mathbf{x})\mathbf{x}_S, v(\mathbf{x})\mathbf{x}_R, \mathbf{x}_D) = 0 \quad (7.6.8)$$

Thus, from (7.6.3) and (7.6.8),

$$\{\mathbf{x} \mid g_r(\mathbf{x}) = 0\} = \{\mathbf{x} \mid \kappa_r(\mathbf{x}) = 1\} \subset \{\mathbf{x} \mid g_i(\mathbf{x}_S, v(\mathbf{x})\mathbf{x}_R, \mathbf{x}_D) = 0\} \quad (7.6.9)$$

Assume that \mathbf{y} is a point of the last set in (7.6.9) but not of the first set in (7.6.9). Substitute $(\mathbf{x}_S, \mathbf{x}_R, \mathbf{x}_D) = \mathbf{y}$ in the identity (7.6.8). Then it follows that (7.6.8) is satisfied for $\kappa_r = 1$ but also for a value of κ_r different from 1, that is, (7.6.4) is satisfied for both $\kappa_i = 1/v(\mathbf{y})$ and $\kappa_i = \kappa_r/v(\mathbf{y})$. This is a contradiction with the star-shape assumption. Thus (7.6.9) is valid with \subset replaced by $=$. This concludes the proof. \square

Equation (7.6.5) is just as elaborate as (7.6.1), of course. However, if the two models qualitatively behave in the same way (and they should in the essentials do so because they are models of the same physical phenomenon) then it is reasonable to expect that the effectivity factor $v(\mathbf{x})$ locally can be approximated well with a constant. Assuming this to be so, (7.6.5) is replaced by

$$g_i(\mathbf{x}_S, v^* \mathbf{x}_R, \mathbf{x}_D) = 0 \quad (7.6.10)$$

as an approximation to elaborate equation (7.6.1) in a more or less wide neighborhood of any point \mathbf{x}^* at which $v^* = v(\mathbf{x}^*)$ is calculated.

The problem is now reduced to the problem of how to choose the point of approximation \mathbf{x}^* . Of course, according to FORM the best choice of v^* is obtained if it happens to be equal to the unknown value of $v(\mathbf{x})$ at the most central point $\mathbf{x} = \mathbf{x}^*$ of elaborate limit state (7.6.1). Given that $v(\mathbf{x})$ actually has a point of stationarity at \mathbf{x}^* , that is, given that all the partial derivatives of $v(\mathbf{x})$ are zero at \mathbf{x}^* , then the two limit-state surfaces defined by (7.6.1) and (7.6.10) are tangential to each other at \mathbf{x}^* . Thus the two limit states have \mathbf{x}^* in common as a point that satisfies the necessary

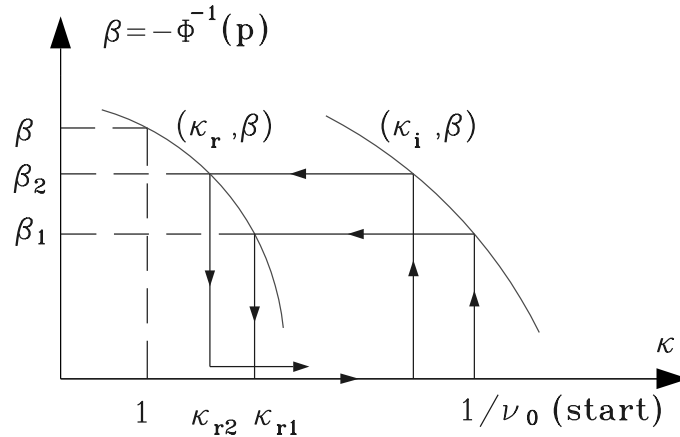

Figure 7.7: Illustration of iteration.

conditions for being a most central point also for the limit state given by (7.6.10). Therefore the following iterative procedure directly suggests itself.

With a judgementally chosen value ν_0 of ν^* a first- or second-order reliability analysis (FORM or SORM) is made with (7.6.10) as the limit-state equation. This analysis determines the most central point \mathbf{x}_1 and an approximate failure probability p_1 corresponding to the limit state $g_i(\mathbf{x}_S, \nu_0 \mathbf{x}_R, \mathbf{x}_D) = 0$. Using $\kappa_i(\mathbf{x}_1) = 1/\nu_0$, an improved value $\nu_1 = \nu_0 \kappa_{r1}$ of ν^* is calculated, where $\kappa_{r1} = \kappa_r(\mathbf{x}_1)$ is obtained by solving (7.6.3) with respect to κ_r for $(\mathbf{x}_S, \mathbf{x}_R, \mathbf{x}_D) = \mathbf{x}_1$. Then a new FORM or SORM analysis is made with (7.6.10) as the limit-state equation and $\nu^* = \nu_1$. This gives the most central point \mathbf{x}_2 and the approximate failure probability p_2 . Proceeding iteratively in this way we get a sequence $(\kappa_{r1}, p_1), (\kappa_{r2}, p_2), \dots$ that may or may not be convergent. If the sequence is convergent in the first component, it is also convergent in the second component, and we have $(\kappa_{r1}, p_1), (\kappa_{r2}, p_2), \dots \rightarrow (1, p)$, where p is denoted as the zero-order approximation to the probability of the elaborate failure event \mathcal{F}_T . Moreover, $\mathbf{x}_1, \mathbf{x}_2, \dots \rightarrow \mathbf{x}^*$.

If the sequence is not convergent, the zero-order approximation can be obtained by simple interpolation to the value $\kappa_r = 1$ among points (κ_r, β) [$\beta = -\Phi^{-1}(p)$] corresponding to the sequence or simply obtained for a series of different values of ν_0 , see Fig. 7.7.

If \mathbf{x}^* is not a stationarity point of $\nu(\mathbf{x})$, the zero-order approximation to the probability of failure may still be an applicable approximation. A check of the goodness of the zero-order approximation can be made by replacing the effectivity factor $\nu(\mathbf{x})$ by its first-order Taylor expansion

$$\nu(\mathbf{x}) \approx \tilde{\nu}(\mathbf{x}) = \nu^* + \mathbf{a}^T (\mathbf{x}_S - \mathbf{x}_S^*) + \mathbf{b}^T (\mathbf{x}_R - \mathbf{x}_R^*) + \mathbf{c}^T (\mathbf{x}_D - \mathbf{x}_D^*) \quad (7.6.11)$$

at the most central point \mathbf{x}^* corresponding to the limit state defined by (7.6.10), with ν^* being the effectivity factor value corresponding to $\kappa_r = 1$. The numerical determination of the coefficients $\mathbf{a}, \mathbf{b}, \mathbf{c}$ requires that the values of $\nu(\mathbf{x})$ be known at at least as many points in the vicinity of \mathbf{x}^* as the number of variables in \mathbf{x} . These values of ν are obtained by solving (7.6.3) and (7.6.4) with respect to κ_r and κ_i , respectively, at each chosen point \mathbf{x} .

Upon substitution of $\tilde{\nu}(\mathbf{x})$ given by (7.6.11) into (7.6.5) in place of $\nu(\mathbf{x})$, a limit state is obtained for which both the probability of failure and the value of κ_r in general will be different from the

probability p and the value $\kappa_r = 1$ as obtained by the zero-order approximation. However, by a unique scaling factor k_r on the load vector \mathbf{x}_S it can be achieved that the limit state defined by

$$g_r(k_r \mathbf{x}_S, \mathbf{x}_R, \mathbf{x}_D) = 0 \quad (7.6.12)$$

or equivalently by

$$g_i[k_r \mathbf{x}_S, v(k_r \mathbf{x}_S, \mathbf{x}_R, \mathbf{x}_D) \mathbf{x}_R, \mathbf{x}_D] = 0 \quad (7.6.13)$$

corresponds to the failure probability p . With the Taylor expansion (7.6.11) substituted into (7.6.13), the limit state

$$g_i[k_r \mathbf{x}_S, \tilde{v}(k_r \mathbf{x}_S, \mathbf{x}_R, \mathbf{x}_D) \mathbf{x}_R, \mathbf{x}_D] = 0 \quad (7.6.14)$$

is obtained. The factor k_r can be determined by iterative application of FORM or SORM analysis such that the corresponding failure probability becomes p . The pair (k_r, p) will be called the first order approximation. The size of the deviation of k_r from 1 can then be used to judge the accuracy of the zero order approximation. Also the change of the most central point from that of (7.6.10) to that of (7.6.14) contributes to this judgment.

For limit state problems in high-dimensional spaces the step beyond the zero-order approximation may require major computer efforts. However, a check of the accuracy of the zero-order approximation is manageable by a Monte Carlo simulation estimation of the angle between the position vector that the approximate most central limit state point and the normal vector to the limit state surface at the same point. The method is described in Section 11.5 as gradient angle estimation by uniform directional simulation on a cone. If sufficiently small, the knowledge of the angle obviously makes it possible by projection to obtain a first order correction of the error on the geometric reliability index. The accuracy of the correction depends on the size of the angle and the curvature properties of the limit state surface in the vicinity of the most central limit point.

Finally it is noted that the formulations of the elaborate and the simple limit states are made in a common space of basic variables. Often the number of basic variables can be larger in the elaborate model than in the simple model. This means that the simple limit state is "cylindric" in the direction of the axes of the basic variables that contribute to the elaborate model but not to the simple model. Thus those elements of \mathbf{x}^* that correspond to the extra basic variables are equal to the mean values (or similar central values) of the respective random variables.

Clearly, if the extra basic variables get dominant influence in the reliability analysis made with the Taylor expansion of the effectivity factor the simple model is too simplified to capture the essentials of the considered reliability problem.

Remark 7.4 The dimension homogeneity property (7.6.7) has the interesting consequence that any physically admissible limit-state surface in the standard Gaussian space is invariant to the multiplication of all the basic strength and load variables \mathbf{x}_F in the physical formulation space by any nonnegative function of the basic variables $\mathbf{x} = (\mathbf{x}_F, \mathbf{x}_D)$.

To see this let $\mathbf{X} = (\mathbf{X}_F, \mathbf{X}_D)$ be a random vector with a given joint distribution and assume that there is a one-to-one transformation T such that $\mathbf{X} = T(\mathbf{U}) = [T_F(\mathbf{U}), T_D(\mathbf{U})]$ where \mathbf{U} is a standard

Gaussian random vector. Then the limit state in the standard Gaussian space obtained by this transformation is given by an equation $G(\mathbf{u}) = 0$, where

$$G(\mathbf{u}) = g[T(\mathbf{u})] \quad (7.6.15)$$

Consider now a situation where \mathbf{X}_F is multiplied by an everywhere positive dimensionless function $a(\mathbf{X})$ of \mathbf{X} ; that is, let the joint distribution of \mathbf{X} be replaced by the joint distribution of $[a(\mathbf{X})\mathbf{X}_F, \mathbf{X}_D]$. The transformation T_a between the $[a(\mathbf{x})\mathbf{x}_F, \mathbf{x}_D]$ -space and the standard Gaussian space is simply obtained from the old transformation T by $T_a(\mathbf{U}) = \{a[T(\mathbf{U})]T_F(\mathbf{U}), T_D(\mathbf{U})\}$. The limit state equation in the standard Gaussian space is given by the equation $g\{a[T(\mathbf{u})]T_F(\mathbf{u}), T_D(\mathbf{u})\} = 0$, which according to (7.6.7) and (7.6.15) defines the same surface as the equation $G(\mathbf{u}) = 0$. \square

Example 7.11 Consider a slender knee frame as defined in Fig. 7.8. The displacements caused by the force F are sufficiently large to make the secondary bending moments coming from F be dominating for the collapse situation. Thus an elaborate mechanical analysis model (e.g. a finite-element model) is needed. The standard critical mechanism in rigid-plastic theory (d) obviously carries no resemblance with the collapse displacement of the frame (b). However, with a reasonable conception about the displacement field of the elastic-plastic frame just before collapse, the potential yield hinge positions of a rigid plastic model are chosen *ad hoc* at the points 2 and 5 excluding the possibility that the reliability analysis for the rigid-plastic model automatically points out the standard mechanism (d) as the most critical mechanism. The formulated rigid-plastic model defines a mechanically based response surface that can be well adapted to the limit state corresponding to collapse of the elaborate elastic-plastic model even with dominant geometric nonlinear behavior.

The data of the frame structure in Fig: 7.8 are

$L = 10$ [m]; rectangular cross-section: height \times width = 0.296 [m] \times 0.026 [m]; Young's modulus: 2.1×10^5 [MPa]; F : Gaussian, $E[F] = \mu_F$, $V_F = 0.2$; e : Gaussian, $E[e] = 0.1$ [m], $V_e = 0.2$; f_y (yield stress): lognormal, $E[f_y] = 400$ [MPa], $V_{f_y} = 0.1$, $\text{Cov}[f_y^{1-3}, f_y^{4-6}] = 0.3\text{Var}[f_y]$, no other correlation.

In this specific example it is almost obvious in advance that it is sufficient solely to consider the points 2 and 5 as potential yield-hinge points. However, for larger structures under more complicated load configurations there can be several failure modes corresponding to the complicated model. This should be reflected also in the idealized rigid-plastic model by choosing a reasonably large number of separated potential rotation hinges in the model.

The point is that the probabilistically important mechanisms obtained from the reliability analysis at least crudely behave like the elaborate model with respect to geometric nonlinearity. A mechanism that has bad similarity with some reasonable displacement field of the complicated model is expected to be less suitable for defining an applicable response surface. For the knee frame considered here the obtained FORM results are presented in Fig. 7.9. (The calculations have been made by use of the program PROBAN version 3.0 installed on an HP9000/730 computer). The geometric reliability index β is shown as function of the mean μ_F of the force F for the different steps of approximation. The curve marked "simple model" corresponds to the rigid-plastic mechanism (c) without effectivity-factor reduction of the yield stress. The four points marked by

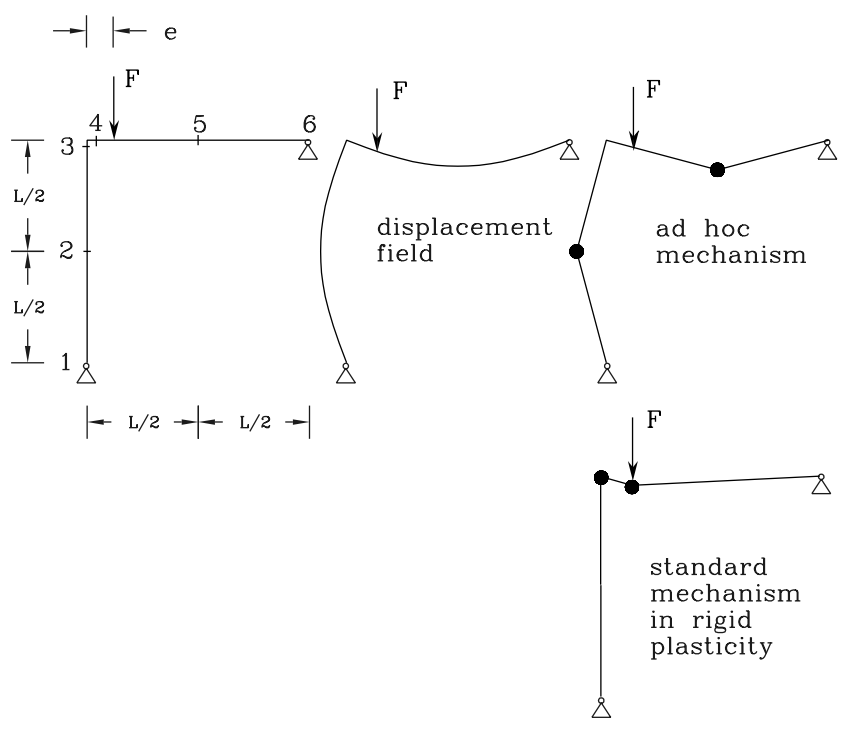

Figure 7.8: Slender knee frame of material with elastic-plastic constitutive relation (a). The displacement field (b) is idealized to the mechanism-displacement field (c) which is completely different from the standard critical mechanism (d) in rigid-plastic theory.

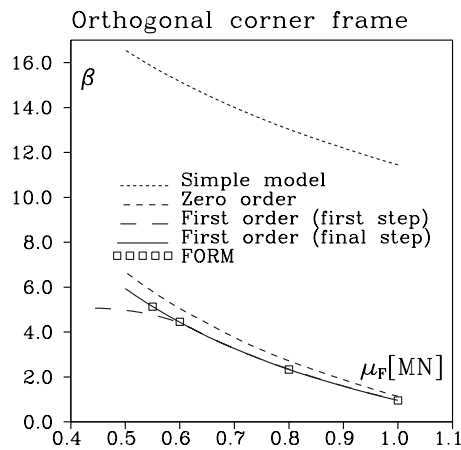

Figure 7.9: Geometric reliability index β as function of the mean load level μ_F for the knee frame in Fig. 7.8.

squares are calculated solely within a finite-element model of the frame. (CPU-time \approx 1 hour per point). It is seen that the reduction of the reliability index due to geometric nonlinearity is very large. Nevertheless, even the zero-order approximation comes quite close to the correct results, and already the first step of the first-order approximation is very accurate except for the smallest considered value of μ_F (i.e. for $\mu_F = 0.55$ [MN]) (CPU time to obtain the zero-order approximation and the first step of the first-order approximation was some few minutes per point). The first-order analysis with iterative changing of the most central point ended up giving perfect agreement with correct FORM result also for $\mu_F = 0.55$ [MN] (CPU time 10 minutes).

Further details on this example and another example including details about the formulation of the finite-element model are given in [7.10]. Successful applications of the model-correction-factor method are illustrated for other types of structural behavior in [7.6] and [7.12]. \square

7.7 Historical and bibliographical notes

The necessity of standardization of types of transformations or distributions for the removal of informational symmetry disturbances was discussed by O. Ditlevsen in 1979 [6.4]. The Nataf distribution [7.14] was suggested and analyzed by A. Der Kiureghian and P-L. Liu in 1986 [7.3, 7.13] as a useful candidate for a multidimensional code specified distribution for the evaluation of structural reliability in cases where solely the marginal distribution types are given.

The Hermite polynomial transformation has been investigated for a variety of reliability applications by S.R. Winterstein in 1985, 1987 [7.19] and later.

The usefulness of the Rosenblatt transformation [7.17] for the calculation of reliability indices on the basis of completely specified joint distribution information was demonstrated by M. Hohenbichler and R. Rackwitz in 1981 [7.7].

The simple idea to approximate distribution tails by normal distribution tails is old, of course. In investigations for setting up a rational basis for codes of structural reliability the principle was applied by J. Benjamin and N. C. Lind in 1969 [7.1] and by E. Paloheimo and M. Hannus in 1974 [7.15]. An algorithm for the construction of a sequence of increasingly better approximating normal distributions was formulated and tested on a special probability problem (see the chapter on load combinations) by R. Rackwitz and B. Fiessler in 1978 [7.16] and more generally by M. Hohenbichler and R. Rackwitz in 1981 [7.7]. In its point sequence construction the algorithm works as the well-known Newton-Raphson iteration principle and it has in parallel with optimization methods gained wide spread application under the name Rackwitz-Fiessler's algorithm for the calculation of the geometric reliability index.

O. Ditlevsen and H.O. Madsen gave in 1980 [7.4] and 1981 [7.5] the clarifying interpretation of the algorithm based on Theorem 7.1 that it in the case of convergence leads to a locally most central point on the image in the Gaussian formulation space of the limit-state surface.

The method of calculating approximative distribution function values of the multidimensional normal distribution by use of FORM or SORM was suggested by M. Hohenbichler in 1982 [7.8] and investigations of the accuracy of the method was published by M. Hohenbichler and R. Rackwitz in 1983 [7.9].

Response-surface methods for dealing with complicated limit states in structural reliability have been used first by D. Veneziano et al in 1983 [7.18] and further investigated by L. Faravelli [7.2]. In particular, she investigated the use of methods of experimental planning to numerical experiments for determination of response surfaces. The basis for the model-correction-factor method was formulated in 1991 by O. Ditlevsen. Detailed investigations on examples have been made by T. Arnbjerg-Nielsen et al, J.M. Johannesen et al, and P. Franchin et al [7.6, 7.10, 7.12, 7.20].

Bibliography

- [7.1] I. Benjamin and N.C. Lind (1969) A probabilistic basis for a deterministic code. *Journal of the American Concrete Institute*, **66**,857-865.
- [7.2] F. Casciati and L. Faravelli (1991): *Fragility Analysis of Complex Structural Systems*. Research Studies Press, Taunton.
- [7.3] A. Der Kiureghian and P-L. Liu (1986) Structural reliability under incomplete probability information. *Journal of Eng. Mech.*, ASCE, **112**, 85-104.
- [7.4] O. Ditlevsen and H.O. Madsen (1980) Discussion of "Optimal Reliability of Probabilistic Design", by N.C. Lind. *Journal of Eng. Mech.*, ASCE, **106**, 579-583.
- [7.5] O. Ditlevsen (1981) Principle of normal tail approximation. *Journal of Eng. Mech.*, ASCE, **107**, 1191-1208.
- [7.6] O. Ditlevsen and T. Arnbjerg-Nielsen (1994) Model-correction-factor method in structural reliability. *Journal of Eng. Mech.*, ASCE, **120**(1), 1 - 10.
- [7.7] M. Hohenbichler and R. Rackwitz (1981) Non-Normal Dependent Variables in Structural Reliability. *Journal of Eng. Mech.*, ASCE, **107**, 1227-1238.
- [7.8] M. Hohenbichler (1982) An approximation to the multivariate normal distribution. In *Reliability Theory of Structural Engineering Systems DIALOG 6-82* (ed. G. Mohr), Proc. of Euromech 155, June 1982. DIAB, Lyngby, pp. 79-110.
- [7.9] M. Hohenbichler and R. Rackwitz (1983) First-order concepts in system reliability. *Structural Safety*, **1**, 177-188.
- [7.10] J.M. Johannesen and O. Ditlevsen (1993) Reliability analysis of geometric nonlinear structure by rigid-plastic model. *Proc. of IFIP 5th WG 7.5 Working Conference on Reliability and Optimization of Structures Systems*. Takamatsu-shi, Kagawa, Japan, 1993. IFIP Transactions B-12, North-Holland, pp. 95-103.
- [7.11] N.L. Johnson and S. Kotz (1970) *Continuous Univariate Distributions*. Wiley, New York.
- [7.12] M. Karlsson, J.M. Johannesen, and O. Ditlevsen (1993) Reliability analysis of an existing bridge. IABSE Colloquium on Remaining Structural Capacity, Copenhagen 1993. *IABSE Report*, **67**, 19-28.
- [7.13] P-L. Liu and A. Der Kiureghian (1986) Multivariate distribution models with prescribed marginals and covariances. *Probabilistic Engineering Mechanics*, **1**(2), 105-112.
- [7.14] A. Nataf (1962) Determination des distribution dont les marges sont données. *Comptes Rendus de l'Academie des Sciences*, **225**, 42-43.

-
- [7.15] E. Paloheimo and M. Hannus (1974) Structural design based on weighted fractiles. *Journal of the Structural Division*, ASCE, **100**, 1367-1378.
- [7.16] R. Rackwitz and B. Fiessler (1978) Structural reliability under combined random load sequences. *Computers and Structures*, **9**, 489-494.
- [7.17] M. Rosenblatt (1952) Remarks on a multivariate transformation. *Ann. Math. Stat.*, **23**, 470-472.
- [7.18] D. Veneziano, F. Casciati, and L. Faravelli (1983) Method of seismic fragility for complicated systems. *Proc. of the 2nd Committee on the Safety of Nuclear Installations (CSNI). Specialistic Meeting on Probabilistic Methods in Seismic Risk Assessment for NPP*, Livermore, California.
- [7.19] S.R. Winterstein (1988) Nonlinear vibration models for extremes and fatigue *Journal of Eng. Mech.*, ASCE, **114**, 1772-1790.
- [7.20] P. Franchin, O. Ditlevsen, and A. Der Kiureghian (2002) Model Correction Factor Method for Reliability Problems Involving Integrals of Non-Gaussian Random Fields. *Probabilistic Engineering Mechanics*, **17**, 109-122.

Chapter 8

SENSITIVITY ANALYSIS

8.1 Measure for the importance of input variables

For almost plane limit-state surfaces in the standardized Gaussian space (in which the points will be denoted by \mathbf{u}) we can with sufficient accuracy approximate the generalized reliability index by the simple reliability index

$$\beta = \frac{E[M]}{D[M]} \quad (8.1.1)$$

where the linear safety margin M corresponds to the tangent hyperplane at the globally most central limit-state point. In particular we can let M have the form

$$M = \beta - \boldsymbol{\alpha}^T \mathbf{U} \quad (8.1.2)$$

where \mathbf{U} is a standard Gaussian vector and $\boldsymbol{\alpha}$ is the normal unit vector to the limit-state surface at the most central point. Then

$$\text{Var}[M] = \alpha_1^2 + \dots + \alpha_n^2 = 1 \quad (8.1.3)$$

implying that α_i^2 is the fraction of the variance of the safety margin that is caused by the standardized normally distributed random variable

$$U_i = \mathbf{a}_i^T (\mathbf{X} - \boldsymbol{\mu}) \quad (8.1.4)$$

where \mathbf{X} is the vector of random input variables and $\boldsymbol{\mu}$ is the mean value vector of \mathbf{X} . If the transformation matrix $[\mathbf{a}_1 \dots \mathbf{a}_n]^T$ is a diagonal matrix, the variables X_1, \dots, X_n are uncorrelated. Then α_i^2 is that fraction of the variance of the safety margin that originates from X_i .

If the input variables contained in \mathbf{X} are mutually dependent, the interpretation of α_i^2 must be more cautious because α_i^2 is related to the linear combination (8.1.4). However, often the input variables can be separated into several sets that are mutually uncorrelated. For each such set the sum of the α_i^2 -parameters gives the fraction of the variance of the safety margin originating from the uncertainty in this set.

Another useful measure for the importance of the uncertainty of an input variable is the *omission sensitivity factor*. This factor expresses the relative error in the value of the geometric reliability index if an input variable is replaced by a fixed value.

If the i th random variable U_i in \mathbf{U} is replaced by a fixed value u_i , the safety margin M in (8.1.2) is changed to the conditional safety margin

$$M(\mathbf{U} | U_i = u_i) = \beta - \alpha_i u_i - \sum_{j \neq i} \alpha_j U_j \quad (8.1.5)$$

with the simple reliability index

$$\beta_{M|U_i=u_i} = \frac{E[M | U_i = u_i]}{D[M | U_i = u_i]} = \frac{\beta - \alpha_i u_i}{\sqrt{1 - \alpha_i^2}} \quad (8.1.6)$$

The omission sensitivity factor is then defined as

$$\zeta(U_i = u_i) = \frac{\beta_{M|U_i=u_i}}{\beta} = \frac{1 - \alpha_i u_i / \beta}{\sqrt{1 - \alpha_i^2}} \quad (8.1.7)$$

More generally, we define the omission sensitivity factor

$$\zeta(U_1 = u_1, \dots, U_q = u_q) = \frac{1 - \sum_{i \in I} \alpha_i u_i / \beta}{\sqrt{1 - \sum_{i \in I} \alpha_i^2}} \quad (8.1.8)$$

where u_1, \dots, u_q are fixed replacement values for U_1, \dots, U_q and $I = \{1, \dots, q\}$. For simplicity of notation we have assumed that it is the q first elements of \mathbf{U} that are replaced by fixed values.

Assume that the transformation from the random input vector \mathbf{X} to the normalized Gaussian vector \mathbf{U} is the marginal transformation, that is, assume that U_i is determined solely by X_i for all $i = 1, \dots, n$, see (7.2.1). Then the omission sensitivity factor (8.1.8) by its deviation from 1 measures the effect of X_1, \dots, X_q being replaced by the fixed values x_1, \dots, x_q . These values are transformed into

$$u_k = \Phi^{-1}[F_{X_k}(x_k)] \quad (8.1.9)$$

before substitution into (8.1.8). If x_k is chosen as the median in the distribution for X_k , we get $u_k = 0$. By this the omission sensitivity factor formula gets its numerator equal to 1.

Two important practical applications of the omission sensitivity factor are as follows:

1. If the value α_i in absolute value is less than 0.14, the relative error of the geometric reliability index is less than 1% if X_i is replaced by its median. In practical situations it is therefore possible to identify random input variables that can be replaced by fixed values without introducing any essential error in the value of the geometric reliability index.

2. The globally most central point is often determined by iterative methods. These methods use the value of the gradient vector to the limit-state function in each iteration, see (7.4.9). Many general computer programs contain a numerical method for the calculation of the gradient vector. Dependent of the applied difference operator this calculation requires one or two extra calls to

the limit-state function for each input variable. Since the total computer time by and large is proportional to the number of calls to the limit-state function it is important that the number of calls is made as small as possible. A call to the limit-state function may, for example, imply solution of large systems of equations or numerical solution of differential equations. It is seen from (8.1.7) that if the normalized variable U_i is replaced by $\beta\alpha_i/2$, then the relative error in the value of the simple reliability index is

$$\zeta(U_i = \beta\alpha_i/2) \approx \frac{1 - \alpha_i^2/2}{\sqrt{1 - \alpha_i^2}} = 1 + \frac{1}{8}\alpha_i^4 + O(\alpha_i^6) \quad (8.1.10)$$

Thus the error is without any practical importance if α_i is small. The following strategy can therefore be applied to reduce the number of calls to the limit-state function: After the first iteration the input variables with α -values less than a chosen threshold value are identified. In the following iterations these input variables are replaced by the fixed values $u_i^{(m)} = \beta^{(m)}\alpha_i^{(1)}/2$ in which the upper index denotes the iteration number. In this way the value of β is updated in each iteration. Upon reaching a stop criterion for β and the reduced α -vector a control iteration with the complete set of random input variables may be performed. Thereby the error is controlled in situations where the value $\alpha_i^{(1)}$ is far away from the value α_i that corresponds to the locally most central limit-state point. It is noted that the omission sensitivity factor increases according to the formula

$$\zeta(U_j = \beta\alpha_j/2; j = 1, \dots, k) \approx \frac{1 - \sum\alpha_j^2/2}{\sqrt{1 - \sum\alpha_j^2}} = 1 + \frac{1}{8}(\sum\alpha_j^2)^2 + O(\sum\alpha_j^2)^3 \quad (8.1.11)$$

with the number of input variables that are replaced by fixed values. This should be taken into account when choosing the threshold value of omission.

In order to generalize the omission sensitivity factor to the case of mutual dependency between the input variables X_1, \dots, X_n we will consider the effect of assigning fixed values to one or more linear combinations of the standardized Gaussian variables U_1, \dots, U_n . In such a situation the omission sensitivity factor is determined by the ratio, see (4.4.14),

$$\zeta(\mathbf{N} = \mathbf{0}) = \frac{\beta_{M|\mathbf{N}=\mathbf{0}}}{\beta_M} \quad (8.1.12)$$

where M is the linear safety margin (8.1.2) corresponding to the globally most central limit-state point while \mathbf{N} is the vector of linear safety margins (or event margins) that correspond to the mentioned linear combinations of U_1, \dots, U_n . With \mathbf{N} written as

$$\mathbf{N} = \mathbf{z} - \mathbf{K}\mathbf{U} \quad (8.1.13)$$

we then get from (4.4.14) to (4.4.17) that

$$\zeta(\mathbf{N} = \mathbf{0}) = \frac{1 - \boldsymbol{\alpha}^T \mathbf{K}^T (\mathbf{K}\mathbf{K}^T)^{-1} \mathbf{z} / \beta}{\sqrt{1 - \boldsymbol{\alpha}^T \mathbf{K}^T (\mathbf{K}\mathbf{K}^T)^{-1} \mathbf{K}\boldsymbol{\alpha}}} \quad (8.1.14)$$

where $\beta = \beta_M = E[M]/D[M]$. If $\mathbf{K}\mathbf{K}^T$ is a unit matrix, (8.1.14) is reduced to (8.1.8). In general the transformation between \mathbf{X} and \mathbf{U} is nonlinear. We then have functions h_1, \dots, h_n such that

$$x_i = h_i(u_1, \dots, u_n) \quad (8.1.15)$$

where h_i is not necessarily linear. If the random input variable X_i is kept fixed at the value x_i , it therefore means that $\mathbf{U} = (U_1, \dots, U_n)$ is tied to be situated on the surface defined by (8.1.15) in the normalized Gaussian space. If h_i is linear, (8.1.15) defines a hyperplane so that a Gaussian subspace is obtained. If h_i is nonlinear and a function of two or more variables, this Gaussian subspace property is lost, however. Therefore it is necessary to define a new transformation from the parallel shifted subspace of the space of input variables that corresponds to the fixing of x_i at a constant value. This complicates the formulation of a general omission sensitivity factor. There is another way, however. When considering the purpose of replacing X_i with the constant value x_i , namely to obtain a cut down of the number of variables without an essential change of the reliability index, we may just as well let X_i have some random variation as obtained by linearizing the right side of (8.1.15) at a suitable point that satisfies (8.1.15). Such a point might be the most central point on the surface defined by (8.1.15). This defines a linear safety margin that can be included as an element of \mathbf{N} .

8.2 Importance measures related to input parameters for element reliability

8.2.1 One parameter case

The deterministic input variables and the parameters in the distributions for the random input variables are denoted as input parameters. The sensitivity of the reliability measure with respect to changes in these input parameters is important for an easy evaluation of the change of the reliability for a given change of the design of the structure. In connection with an optimization procedure aiming at minimal total costs, the sensitivities can be used in the iterative solution methods.

For a locally most central point \mathbf{y} on the limit-state surface in the standardized Gaussian space of points \mathbf{u} we have, see (8.1.1) and (8.1.2),

$$\mathbf{y} = \boldsymbol{\alpha}\beta \quad (8.2.1)$$

$$\boldsymbol{\alpha} \propto -\nabla g(\mathbf{y}; \theta), \quad \nabla = \left\{ \frac{\partial}{\partial u_i} \right\}_{\mathbf{u}=\mathbf{y}} \quad (8.2.2)$$

$$\boldsymbol{\alpha}^T \boldsymbol{\alpha} = 1 \quad (8.2.3)$$

$$g(\mathbf{y}; \theta) = 0 \quad (8.2.4)$$

where θ is a parameter and $g(\cdot; \theta)$ is the limit-state function. It follows from this that β is a function of θ . The sensitivity of β with respect to changes in θ are measured by the derivative $d\beta/d\theta$.

For calculation of $d\beta/d\theta$ it is convenient to define the limit-state function such that the gradient of g has the length 1 everywhere on the limit state surface, that is, such that

$$\|\nabla g(\mathbf{u}; \theta)\| = 1 \quad \text{for all } \mathbf{u} \text{ for which } g(\mathbf{u}; \theta) = 0 \quad (8.2.5)$$

Remark 8.1 If g is not defined such that (8.2.5) is satisfied, we only need to divide g by $\|\nabla g\|$. This follows from the fact that

$$\frac{\partial}{\partial \theta} \frac{g}{\|\nabla g\|} = \frac{\|\nabla g\| \frac{\partial g}{\partial \theta} - g \frac{\partial \|\nabla g\|}{\partial \theta}}{\|\nabla g\|^2} = \frac{1}{\|\nabla g\|} \frac{\partial g}{\partial \theta} \quad (8.2.6)$$

at all points \mathbf{u} at which $g(\mathbf{u}; \theta) = 0$, that is, (8.2.6) is valid everywhere on the limit-state surface. This shows that (8.2.5) is valid with g replaced by $g/\|\nabla g\|$. \square

The formulas (8.2.1) and (8.2.3) show that

$$\beta = \boldsymbol{\alpha}^\top \mathbf{y} \quad (8.2.7)$$

from which it follows that

$$\frac{d\beta}{d\theta} = \frac{d\boldsymbol{\alpha}^\top}{d\theta} \mathbf{y} + \boldsymbol{\alpha}^\top \frac{d\mathbf{y}}{d\theta} = \boldsymbol{\alpha}^\top \frac{d\mathbf{y}}{d\theta} \quad (8.2.8)$$

The first term on the right-hand side of (8.2.8) is zero because $d\boldsymbol{\alpha}/d\theta$ and $\boldsymbol{\alpha}$ are mutually orthogonal and $\mathbf{y} = \boldsymbol{\alpha}\beta$. The orthogonality is verified directly by differentiation of (8.2.3). Differentiation of (8.2.4) gives

$$\frac{d\mathbf{y}}{d\theta} = \frac{\partial \mathbf{y}}{\partial \theta} + \sum_{i=1}^n \frac{dy_i}{d\theta} \left(\frac{\partial \mathbf{y}}{\partial u_i} \right)_{\mathbf{u}=\mathbf{y}} = \frac{\partial \mathbf{y}}{\partial \theta} - \boldsymbol{\alpha}^\top \frac{d\mathbf{y}}{d\theta} = 0 \quad (8.2.9)$$

using (8.2.2). By comparison of (8.2.8) and (8.2.9) it is seen that $d\beta/d\theta = \partial g/\partial \theta$. If (8.2.5) is not satisfied, we use (8.2.6) and find the parameter sensitivity

$$\frac{d\beta}{d\theta} = \frac{1}{\|\nabla g\|} \frac{\partial g}{\partial \theta} \quad (8.2.10)$$

to be calculated at that locally most central limit-state point that corresponds to the considered geometric reliability index.

Under the assumption (8.2.5) the derivative of the normal unit vector $\boldsymbol{\alpha}$ with respect to the parameter θ becomes

$$\frac{d\boldsymbol{\alpha}}{d\theta} = -\frac{d\nabla g}{d\theta} = -\frac{d}{d\theta} \left(\frac{\partial \mathbf{y}}{\partial u_i} \right)_{\mathbf{u}=\mathbf{y}} = \left[-\left\{ \sum_{j=1}^n \frac{\partial^2 g}{\partial u_i \partial u_j} \frac{dy_j}{d\theta} \right\} - \frac{\partial \nabla g}{\partial \theta} \right]_{\mathbf{u}=\mathbf{y}} \quad (8.2.11)$$

or, by differentiation of (8.2.1) to obtain $dy_j/d\theta$, and rearrangement:

$$\frac{d\boldsymbol{\alpha}}{d\theta} + \mathbf{D} \left(\frac{d\boldsymbol{\alpha}}{d\theta} \beta + \boldsymbol{\alpha} \frac{d\beta}{d\theta} \right) + \frac{\partial \nabla g}{\partial \theta} = \mathbf{0} \quad (8.2.12)$$

where

$$\mathbf{D} = \left\{ \frac{\partial^2 g}{\partial u_i \partial u_j} \right\}_{\mathbf{u}=\mathbf{y}} = \left[-\frac{\partial \boldsymbol{\alpha}}{\partial u_1} \cdots -\frac{\partial \boldsymbol{\alpha}}{\partial u_n} \right]_{\mathbf{u}=\mathbf{y}} \quad (8.2.13)$$

It is seen from (8.2.13) that $\mathbf{D}\boldsymbol{\alpha} = \mathbf{0}$. Using this in (8.2.12) we get

$$\frac{d\boldsymbol{\alpha}}{d\theta} = -(\mathbf{I} + \beta\mathbf{D})^{-1} \frac{1}{\|\nabla g\|} \frac{\partial \nabla g}{\partial \theta} \quad (8.2.14)$$

where $\partial \nabla g / \partial \theta = \nabla \partial g / \partial \theta$, and where the formula has been corrected to the general case where $\|\nabla g\|$ may be different from 1, also implying that

$$\mathbf{D} = \frac{1}{\|\nabla g\|} \left[\frac{\partial^2 g}{\partial u_i \partial u_j} - \frac{1}{\|\nabla g\|} \left(\frac{\partial g}{\partial u_i} \frac{\partial \|\nabla g\|}{\partial u_j} + \frac{\partial g}{\partial u_j} \frac{\partial \|\nabla g\|}{\partial u_i} \right) \right]_{\mathbf{u}=\mathbf{y}} \quad (8.2.15)$$

The interpretation of the derivatives appearing in (8.2.14) is that $\partial \nabla g / \partial \theta$ is calculated at the most central point \mathbf{y} on the limit-state surface corresponding to θ being fixed at the actual value θ_0 . The vectorial increment $d\boldsymbol{\alpha}$, however, represents the change of $\boldsymbol{\alpha}$ as a consequence of the shift of the most central point as it shifts together with the limit-state surface when θ varies from θ_0 to $\theta_0 + d\theta$.

8.2.2 The two main cases

Two different main cases of application of the formula (8.2.10) for $d\beta/d\theta$ deserve attention. The first case appears if θ is a deterministic input variable, that is, a parameter that concerns the definition of the limit state. We can then express the two to each other corresponding limit-state functions in the space of the free physical input variables and in the standardized Gaussian space by

$$g(\mathbf{u}; \theta) = g[T(\mathbf{x}); \theta] = G(\mathbf{x}; \theta) \quad (8.2.16)$$

where $\mathbf{u} = T(\mathbf{x})$ is the given transformation. It then follows that

$$\frac{\partial g}{\partial \theta} = \frac{\partial G}{\partial \theta} \quad (8.2.17)$$

The second case appears if θ is a distribution parameter. Such a parameter has no influence on the limit state in the free physical formulation space. The influence on the limit state in the standardized Gaussian space is solely through the transformation $\mathbf{u} = T(\mathbf{x}; \theta)$. We have

$$g(\mathbf{u}; \theta) = G(\mathbf{x}) \quad (8.2.18)$$

where the right side is independent of θ . Therefore the partial derivative of the left hand side of (8.2.18) with respect to θ is zero identically, that is,

$$\nabla g^\top \frac{\partial \mathbf{u}}{\partial \theta} + \frac{\partial g}{\partial \theta} \equiv 0 \quad (8.2.19)$$

By application of (8.2.2) the formula (8.2.10) then gives

$$\frac{d\beta}{d\theta} = \boldsymbol{\alpha}^\top \left(\frac{\partial \mathbf{u}}{\partial \theta} \right)_{\mathbf{u}=\mathbf{y}} \quad (8.2.20)$$

Comparison of (8.2.20) and (8.2.8) shows that $\partial \mathbf{u} / \partial \theta = \partial T(\mathbf{x}; \theta) / \partial \theta$ has the same component as $d\mathbf{y} / d\theta$ in the direction of $\boldsymbol{\alpha}$ when calculated at the considered locally most central limit-state point $\mathbf{u} = \mathbf{y}$.

Similar formulas apply to (8.2.14).

8.2.3 Several parameters

Usually there will be several parameters $\theta_1, \dots, \theta_m$ in the limit-state equation. In that case the derivatives $d\boldsymbol{\alpha}/d\theta_1, \dots, d\boldsymbol{\alpha}/d\theta_m$ should be interpreted as partial derivatives in the sense that $d\boldsymbol{\alpha}/d\theta_i$ is calculated with $\theta_1, \dots, \theta_{i-1}, \theta_{i+1}, \dots, \theta_m$ kept constant but with the most central point \mathbf{y} varying in dependence of θ_i . To avoid confusion we will use the notation $\delta\boldsymbol{\alpha}/\delta\theta_i$ for these special partial derivatives. The need for this special notation appears directly in the following derivation of a sensitivity measure that has useful applications in connection with the code calibration calculations treated in Appendix 1.

Let $\theta_1 = r$ be some design parameter (a deterministic resistance parameter, say) and let $\theta_2 = \theta$ be some other parameter, both having influence on the limit-state surface defined by the equation

$$g(\mathbf{u}; r, \theta) = 0 \quad (8.2.21)$$

Thus the geometric reliability index β as well as the unit normal vector $\boldsymbol{\alpha}$ at the most central point \mathbf{y} depend on r and θ . The differentials are

$$d\beta = \frac{\delta\beta}{\delta r} dr + \frac{\delta\beta}{\delta\theta} d\theta \quad (8.2.22)$$

$$d\boldsymbol{\alpha} = \frac{\delta\boldsymbol{\alpha}}{\delta r} dr + \frac{\delta\boldsymbol{\alpha}}{\delta\theta} d\theta \quad (8.2.23)$$

For code calibration investigations it is relevant to consider the subfamily of limit state surfaces defined by (8.2.21) such that $\beta(r, \theta) = \beta_t = \text{constant}$ target reliability index. For judging the effects of variations within this subfamily the sensitivity $d\boldsymbol{\alpha}/d\theta$ is useful. Setting $d\beta = 0$, (8.2.22) and (8.2.10) give

$$\frac{dr}{d\theta} = -\frac{\delta\beta/\delta\theta}{\delta\beta/\delta r} = -\frac{\partial g/\partial\theta}{\partial g/\partial r} \quad (8.2.24)$$

whereupon (8.2.23) by use of (8.2.14) gives the sensitivity

$$\frac{d\boldsymbol{\alpha}}{d\theta} = -(\mathbf{I} + \beta\mathbf{D})^{-1} \frac{1}{\|\nabla g\|} \left(-\frac{\partial g/\partial\theta}{\partial g/\partial r} \nabla\partial g/\partial r + \nabla\partial g/\partial\theta \right) \quad (8.2.25)$$

of $\boldsymbol{\alpha}$ with respect to θ for fixed geometric reliability index β . Under this condition the sensitivity of the most central point \mathbf{y} is

$$\frac{d\mathbf{y}}{d\theta} = \beta \frac{d\boldsymbol{\alpha}}{d\theta} \quad (8.2.26)$$

Example 8.1 Let the input variables be mutually independent and let X_1 be Gaussian with mean value μ_1 and standard deviation σ_1 . The transformation $\mathbf{u} = T(\mathbf{x})$ can be chosen as the marginal transformation. In the first variable it is

$$u_1 = \frac{x_1 - \mu_1}{\sigma_1} \quad (8.2.27)$$

According to (8.2.20) the sensitivities with respect to the parameters μ_1 and σ_1 are then

$$\frac{\delta\beta}{\delta\mu_1} = \alpha_1 \frac{\partial}{\partial\mu_1} \left(\frac{x_1 - \mu_1}{\sigma_1} \right)_{u_1=y_1} = -\frac{\alpha_1}{\sigma_1} \quad (8.2.28)$$

$$\frac{\delta\beta}{\delta\sigma_1} = \alpha_1 \frac{\partial}{\partial\sigma_1} \left(\frac{x_1 - \mu_1}{\sigma_1} \right)_{u_1=y_1} = -\alpha_1 \left(\frac{x_1 - \mu_1}{\sigma_1^2} \right)_{u_1=y_1} = -\frac{\alpha_1 y_1}{\sigma_1} = -\frac{\beta\alpha_1^2}{\sigma_1} \quad (8.2.29)$$

□

Exercise 8.1 Let the input variables be mutually independent and let X_2 be logarithmic normally distributed with mean value μ_2 and coefficient of variation V_2 . Show that

$$\frac{\delta\beta}{\delta\mu_2} = -\frac{\alpha_2}{\mu_2 \sqrt{\log(1 + V_2^2)}} \quad (8.2.30)$$

$$\frac{\delta\beta}{\delta V_2} = -\frac{\alpha_2 V_2}{(1 + V_2^2) \sqrt{\log(1 + V_2^2)}} \left(\frac{\beta\alpha_2}{\sqrt{\log(1 + V_2^2)}} - 1 \right) \quad (8.2.31)$$

□

8.2.4 Choice of expansion function

The FORM-approximation to the failure probability is

$$P(\mathcal{F}) = \Phi(-\beta) \quad (8.2.32)$$

The derivative of the failure probability is

$$\frac{dP(\mathcal{F})}{d\theta} = -\varphi(-\beta) \frac{d\beta}{d\theta} \quad (8.2.33)$$

Correspondingly the derivative of the natural logarithm to $P(\mathcal{F})$ is

$$\frac{d \log P(\mathcal{F})}{d\theta} = -\frac{\varphi(\beta)}{\Phi(-\beta)} \frac{d\beta}{d\theta} \quad (8.2.34)$$

For large values of β the asymptotic formula $\varphi(\beta)/\Phi(-\beta) \approx \beta$ is valid, whereby the result is simplified.

If $P(\mathcal{F})$ is mapped as a function of an input parameter, the image graph is in most cases strongly curved. However, if β or $\log P(\mathcal{F})$ is mapped as a function of the input parameter, most often the graph is only slightly curved. Assume that the failure probability is known for a value θ of the input parameter. We want to determine the failure probability corresponding to the parameter value $\theta + \Delta\theta$. A calculation based on

$$P[\mathcal{F}(\theta + \Delta\theta)] \approx P[\mathcal{F}(\theta)] + \frac{dP[\mathcal{F}(\theta)]}{d\theta} \Delta\theta \quad (8.2.35)$$

therefore often will be quite inaccurate except for very small values of $\Delta\theta$. However, a calculation based on

$$P[\mathcal{F}(\theta + \Delta\theta)] = \Phi[-(\beta + \Delta\beta)] \approx \Phi\left[-\left(\beta + \frac{d\beta}{d\theta}\Delta\theta\right)\right] \quad (8.2.36)$$

is often a reasonable approximation even for large values of $\Delta\theta$. Correspondingly we will get a reasonable approximation by setting

$$P[\mathcal{F}(\theta + \Delta\theta)] \approx \exp\left\{\log P[\mathcal{F}(\theta)] + \frac{d\log P[\mathcal{F}(\theta)]}{d\theta}\Delta\theta\right\} \quad (8.2.37)$$

8.3 Importance measures related to the input parameters for parallel-system reliability*

In this section we will consider a failure set of the form

$$\mathcal{F} = \bigcap_{i=1}^m \mathcal{F}_i \quad (8.3.1)$$

that is, a failure set of parallel-system type. The limit-state function corresponding to \mathcal{F}_i in the standardized Gaussian space is denoted $g_i(\cdot; \theta)$, where θ is an input parameter, and it is defined such that its gradient everywhere on the corresponding limit-state surface has the length 1, see (8.2.5). The globally most central point \mathbf{y} on the boundary $\partial\mathcal{F}$ is determined as the solution to the optimization problem

$$\min \|\mathbf{u}\| \quad \text{given} \quad g_1(\mathbf{u}; \theta) \leq 0, \dots, g_m(\mathbf{u}; \theta) \leq 0 \quad (8.3.2)$$

The individual failure sets \mathcal{F}_i are numerated such that

$$\begin{aligned} g_1(\mathbf{u}; \theta) = 0, \dots, g_q(\mathbf{u}; \theta) = 0 \\ g_{q+1}(\mathbf{u}; \theta) < 0, \dots, g_m(\mathbf{u}; \theta) < 0 \end{aligned} \quad (8.3.3)$$

for the optimal solution $\mathbf{u} = \mathbf{y}$.

The FORM-approximation (single-point multiple FORM) to the failure probability is then given by the formula (6.6.7):

$$P(\mathcal{F}) \approx \Phi_q(-\boldsymbol{\beta}; \mathbf{P}) \quad (8.3.4)$$

where \mathbf{P} is the matrix of correlation coefficients between the linearized safety margins at the point \mathbf{y} . The derivative of $\Phi_q(-\boldsymbol{\beta}; \mathbf{P})$ with respect to the input parameter θ is

$$\frac{d\Phi_q(-\boldsymbol{\beta}; \mathbf{P})}{d\theta} = \sum_{i=1}^q \left[-\frac{\partial\Phi_q}{\partial x_i} \frac{d\beta_i}{d\theta} + \sum_{j=1}^{i-1} \frac{\partial\Phi_q}{\partial \rho_{ij}} \frac{d\rho_{ij}}{d\theta} \right]_{\mathbf{x}=\boldsymbol{\beta}} \quad (8.3.5)$$

For the partial derivative of Φ_q we have, see Remark 8.2,

$$\frac{\partial \Phi_q(-\boldsymbol{\beta}; \mathbf{P})}{\partial x_i} = \varphi(x_i) \Phi_{q-1}(\mathbf{x}^i - \boldsymbol{\rho}_i^i x_i; \mathbf{P}^i - \boldsymbol{\rho}_i^i \boldsymbol{\rho}_i^{i\top})_{\mathbf{x}=\boldsymbol{\beta}} \quad (8.3.6)$$

$$\frac{\partial \Phi_q(-\boldsymbol{\beta}; \mathbf{P})}{\partial \rho_{ij}} = \frac{\partial^2 \Phi_q(-\boldsymbol{\beta}; \mathbf{P})}{\partial x_i \partial x_j} = \varphi_2(x_i, x_j; \rho_{ij}).$$

$$\Phi_{q-2} \left(\mathbf{x}^{ij} - \begin{bmatrix} \boldsymbol{\rho}_i^{ij} & \boldsymbol{\rho}_j^{ij} \end{bmatrix} \begin{bmatrix} 1 & \rho_{ij} \\ \rho_{ij} & 1 \end{bmatrix}^{-1} \begin{bmatrix} x_i \\ x_j \end{bmatrix}; \mathbf{P}^{ij} - \begin{bmatrix} \boldsymbol{\rho}_i^{ij} & \boldsymbol{\rho}_j^{ij} \end{bmatrix} \begin{bmatrix} 1 & \rho_{ij} \\ \rho_{ij} & 1 \end{bmatrix}^{-1} \begin{bmatrix} \boldsymbol{\rho}_i^{ij\top} \\ \boldsymbol{\rho}_j^{ij\top} \end{bmatrix} \right) \quad (8.3.7)$$

In these formulas \mathbf{x}^i is obtained from \mathbf{x} by removing the i th row, that is, the element x_i . Correspondingly \mathbf{x}^{ij} is obtained from \mathbf{x} by removing both the i th row and the j th row, that is, both the elements x_i and x_j . The column vector $\boldsymbol{\rho}_i^j$ is the i th column in \mathbf{P} after removal of the j th row, and $\boldsymbol{\rho}_i^{ij}$ is the i th column in \mathbf{P} after removal of both the i th and the j th row; the square matrix \mathbf{P}^i is obtained from \mathbf{P} by removal of the i th row and the i th column, and the square matrix \mathbf{P}^{ij} is obtained by removal of both the i th and the j th row and column from \mathbf{P} .

The vector $\boldsymbol{\beta}$ of simple reliability indices corresponding to the q tangential hyperplanes at point \mathbf{y} can be written as

$$\boldsymbol{\beta} = \mathbf{A}^\top \mathbf{y} \quad (8.3.8)$$

where $\mathbf{A} = [\boldsymbol{\alpha}_1 \ \boldsymbol{\alpha}_2 \ \dots \ \boldsymbol{\alpha}_q]$ with $\boldsymbol{\alpha}_i$ being the normal unit vector to the i th hyperplane. The vector of the corresponding safety margins can then be written as

$$\mathbf{M} = \boldsymbol{\beta} + \mathbf{A}^\top \mathbf{U} \quad (8.3.9)$$

from which it follows that the correlation matrix \mathbf{P} is determined by

$$\mathbf{P} = \text{Cov}[\mathbf{A}^\top \mathbf{U}, \mathbf{U}^\top \mathbf{A}] = \mathbf{A}^\top \mathbf{A} \quad (8.3.10)$$

Since \mathbf{y} is the most central point in the intersection of the q tangential hyperplanes, the point \mathbf{y} must be a point of the q -dimensional subspace spanned by $\boldsymbol{\alpha}_1, \dots, \boldsymbol{\alpha}_q$. If not, the projection of \mathbf{y} on this subspace would be a point in the intersection having less distance to the origin. From this it follows that there is a q -dimensional vector $\boldsymbol{\lambda}$ such that

$$\mathbf{y} = \mathbf{A} \boldsymbol{\lambda} \quad (8.3.11)$$

By multiplication of (8.3.11) from the left by \mathbf{A}^\top and by use of (8.3.8) and (8.3.10) it is seen that

$$\boldsymbol{\beta} = \mathbf{P} \boldsymbol{\lambda} \quad (8.3.12)$$

Differentiation of (8.3.11) with respect to the parameter θ gives

$$\frac{d\mathbf{y}}{d\theta} = \frac{d\mathbf{A}}{d\theta} \boldsymbol{\lambda} + \mathbf{A} \frac{d\boldsymbol{\lambda}}{d\theta} \quad (8.3.13)$$

where

$$\frac{d\mathbf{A}}{d\theta} = \left[\sum_{i=1}^n \frac{\partial \mathbf{A}}{\partial u_i} \frac{dy_i}{d\theta} + \frac{\partial \mathbf{A}}{\partial \theta} \right]_{\mathbf{u}=\mathbf{y}} = \nabla \mathbf{A} * \frac{d\mathbf{y}}{d\theta} + \frac{\partial \mathbf{A}}{\partial \theta} \quad (8.3.14)$$

with

$$\nabla \mathbf{A} = \left[\frac{\partial \mathbf{A}}{\partial u_1} \cdots \frac{\partial \mathbf{A}}{\partial u_n} \right]_{\mathbf{u}=\mathbf{y}} \quad (8.3.15)$$

The composition rule $*$ is defined by (8.3.14) as a generalized row-column multiplication. Since

$$\sum_{j=1}^q \left(\sum_{k=1}^n \frac{\partial a_{ij}}{\partial u_k} \frac{dy_k}{d\theta} \right) \lambda_j = \sum_{k=1}^n \left(\sum_{j=1}^q \frac{\partial a_{ij}}{\partial u_k} \lambda_j \right) \frac{dy_k}{d\theta} \quad (8.3.16)$$

it is seen that

$$\left[\nabla \mathbf{A} * \frac{d\mathbf{y}}{d\theta} \right] \boldsymbol{\lambda} = [\nabla \mathbf{A} \circ \boldsymbol{\lambda}] \frac{d\mathbf{y}}{d\theta} \quad (8.3.17)$$

where the composition rule \circ is defined by

$$\nabla \mathbf{A} \circ \boldsymbol{\lambda} = \left[\frac{\partial \mathbf{A}}{\partial u_1} \boldsymbol{\lambda} \cdots \frac{\partial \mathbf{A}}{\partial u_n} \boldsymbol{\lambda} \right] \quad (8.3.18)$$

By substitution of (8.3.14) in (8.3.13) and use of (8.3.17) we get

$$\frac{d\mathbf{y}}{d\theta} = [\nabla \mathbf{A} \circ \boldsymbol{\lambda}] \frac{d\mathbf{y}}{d\theta} + \frac{\partial \mathbf{A}}{\partial \theta} \boldsymbol{\lambda} + \mathbf{A} \frac{d\boldsymbol{\lambda}}{d\theta} \quad (8.3.19)$$

Implicit differentiation of the equation $\mathbf{g}(\mathbf{u}; \theta) = \mathbf{0}$ (the first line of (8.3.3)) gives

$$\mathbf{A}^\top \frac{d\mathbf{y}}{d\theta} = \frac{\partial \mathbf{g}}{\partial \theta} \quad (8.3.20)$$

because $\nabla \mathbf{g} = -\mathbf{A}^\top$ under the assumption that $\|\nabla g_1\| = \dots = \|\nabla g_q\| = 1$. Since $\mathbf{A}^\top \mathbf{A} = \mathbf{P}$, (8.3.19) can be solved with respect to $d\boldsymbol{\lambda}/d\theta$ after (8.3.19) has been multiplied from the left by \mathbf{A}^\top . Use of (8.3.20) then gives

$$\frac{d\boldsymbol{\lambda}}{d\theta} = \mathbf{P}^{-1} \left[\frac{\partial \mathbf{g}}{\partial \theta} - \mathbf{A}^\top (\nabla \mathbf{A} \circ \boldsymbol{\lambda}) \frac{d\mathbf{y}}{d\theta} - \mathbf{A}^\top \frac{\partial \mathbf{A}}{\partial \theta} \boldsymbol{\lambda} \right] \quad (8.3.21)$$

This result is substituted into (8.3.19) which upon rearrangement becomes

$$[\mathbf{I} + (\mathbf{A}\mathbf{P}^{-1}\mathbf{A}^\top - \mathbf{I})(\nabla \mathbf{A} \circ \boldsymbol{\lambda})] \frac{d\mathbf{y}}{d\theta} = \mathbf{A}\mathbf{P}^{-1} \frac{\partial \mathbf{g}}{\partial \theta} - (\mathbf{A}\mathbf{P}^{-1}\mathbf{A}^\top - \mathbf{I}) \frac{\partial \mathbf{A}}{\partial \theta} \boldsymbol{\lambda} \quad (8.3.22)$$

After this the derivative $d\boldsymbol{\beta}/d\theta$ to be used in (8.3.5) can be written as

$$\frac{d\boldsymbol{\beta}}{d\theta} = \frac{d\mathbf{A}^\top}{d\theta} \mathbf{y} + \mathbf{A}^\top \frac{d\mathbf{y}}{d\theta} = (\nabla \mathbf{A}^\top \circ \mathbf{y}) \frac{d\mathbf{y}}{d\theta} + \frac{\partial \mathbf{A}^\top}{\partial \theta} \mathbf{y} + \frac{\partial \mathbf{g}}{\partial \theta} \quad (8.3.23)$$

in which the last term on the right side is obtained by use of (8.3.20) while the first term follows from (8.3.14) and (8.3.17) with \mathbf{A}^\top in place of \mathbf{A} and with \mathbf{y} in place of $\boldsymbol{\lambda}$. By solution of (8.3.22) with respect to $d\mathbf{y}/d\theta$ and substitution into (8.3.23) we get the the final result

$$\begin{aligned} \frac{d\boldsymbol{\beta}}{d\theta} &= (\nabla\mathbf{A}^\top \circ \mathbf{y}) \left\{ \mathbf{I} + (\mathbf{A}\mathbf{P}^{-1}\mathbf{A}^\top - \mathbf{I})[\nabla\mathbf{A} \circ (\mathbf{P}^{-1}\boldsymbol{\beta})] \right\}^{-1} \\ &\cdot \left[\mathbf{A}\mathbf{P}^{-1} \frac{\partial \mathbf{g}}{\partial \theta} - (\mathbf{A}\mathbf{P}^{-1}\mathbf{A}^\top - \mathbf{I}) \frac{\partial \mathbf{A}}{\partial \theta} \mathbf{P}^{-1} \boldsymbol{\beta} \right] + \frac{\partial \mathbf{A}^\top}{\partial \theta} \mathbf{y} + \frac{\partial \mathbf{g}}{\partial \theta} \end{aligned} \quad (8.3.24)$$

In the special case where $q = n$, the matrix product $\mathbf{A}\mathbf{P}^{-1}\mathbf{A}^\top$ reduces to the unit matrix \mathbf{I} such that (8.3.24) becomes

$$\frac{d\boldsymbol{\beta}}{d\theta} = (\nabla\mathbf{A}^\top \circ \mathbf{y})(\mathbf{A}^\top)^{-1} \frac{\partial \mathbf{g}}{\partial \theta} + \frac{\partial \mathbf{A}^\top}{\partial \theta} \mathbf{y} + \frac{\partial \mathbf{g}}{\partial \theta} \quad (8.3.25)$$

This corresponds to the situation where $d\mathbf{y}/d\theta$ can be determined directly from (8.3.20).

For the other extreme case where $q = 1$ we have $\mathbf{A} = \boldsymbol{\alpha}$, $\boldsymbol{\beta} = \beta$, $\mathbf{y} = \beta\boldsymbol{\alpha}$, $\mathbf{g} = g$, $\boldsymbol{\lambda} = \beta$ such that (8.3.22) reduces to

$$[\mathbf{I} - \beta\nabla\boldsymbol{\alpha}] \frac{d\mathbf{y}}{d\theta} = \boldsymbol{\alpha} \frac{\partial g}{\partial \theta} + \frac{\partial \boldsymbol{\alpha}}{\partial \theta} \beta \quad (8.3.26)$$

by use of $\boldsymbol{\alpha}^\top \nabla\boldsymbol{\alpha} = \mathbf{0}^\top$ and $\boldsymbol{\alpha}^\top \partial\boldsymbol{\alpha}/\partial\theta = 0$.

Since $d\mathbf{y}/d\theta = \beta d\boldsymbol{\alpha}/d\theta + \boldsymbol{\alpha} d\beta/d\theta$, $\nabla\boldsymbol{\alpha}^\top \boldsymbol{\alpha} = \mathbf{0}$, $\partial\boldsymbol{\alpha}/d\theta = -\partial\nabla g/\partial\theta$, $d\beta/d\theta = \partial g/\partial\theta$ the formula (8.3.26) is further reduced to the expression (8.2.14) for $d\boldsymbol{\alpha}/d\theta$.

The derivatives $d\rho_{ij}/d\theta$ of the correlation coefficients are needed in (8.2.5). By differentiation of (8.2.10) we get

$$\frac{d\mathbf{P}}{d\theta} = \frac{d\mathbf{A}^\top}{d\theta} \mathbf{A} + \mathbf{A}^\top \frac{d\mathbf{A}}{d\theta} \quad (8.3.27)$$

with, see (8.2.14),

$$\mathbf{A}^\top \frac{d\mathbf{A}}{d\theta} = \mathbf{A}^\top \left(\nabla\mathbf{A} * \frac{d\mathbf{y}}{d\theta} \right) + \mathbf{A}^\top \frac{\partial \mathbf{A}}{\partial \theta} = (\mathbf{A}^\top \circ \nabla\mathbf{A}) * \frac{d\mathbf{y}}{d\theta} + \mathbf{A}^\top \frac{\partial \mathbf{A}}{\partial \theta} \quad (8.3.28)$$

where $d\mathbf{y}/d\theta$ is determined by (8.2.33). The derivatives $d\boldsymbol{\beta}/d\theta$ and $d\mathbf{P}/d\theta$ are all calculated at the globally most central limit state point \mathbf{y} . It is emphasized once more that *all formulas are based on the property that $\|\nabla g_i\| = 1$ on the i th limit-state surface for all $i \in \{1, \dots, q\}$.*

When the derivative of the approximation to $P(\mathcal{F})$ is determined, the derivative of the corresponding generalized reliability index β is determined by

$$\frac{d\beta}{d\theta} = - \frac{dP(\mathcal{F})/d\theta}{\varphi(\beta)} \quad (8.3.29)$$

Remark 8.2 The formula (8.3.6) for the partial derivative of the q -dimensional normal distribution function $\Phi_q(\mathbf{x}; \mathbf{P})$ with respect to x_i is obtained by the following consideration, see Fig. 8.1.

The partial derivative times the increment dx_i is the probability of getting an outcome in the infinitesimal domain indicated by the shading in Fig. 8.1. Obviously this probability is

$$P(\mathbf{X} \leq \mathbf{x} | X_i = x_i) \varphi(x_i) dx_i \quad (8.3.30)$$

The conditional probability $P(\mathbf{X} \leq \mathbf{x} | X_i = x_i)$ is solely a function of \mathbf{x}^i and it is the $(q-1)$ -dimensional normal distribution function that corresponds to the mean value vector, see (4.3.4),

$$E[\mathbf{X}^i | X_i] = \text{Cov}[\mathbf{X}^i, X_i] X_i = \boldsymbol{\rho}_i^i X_i \quad (8.3.31)$$

and the covariance matrix, see (4.3.5),

$$\text{Cov}[\mathbf{X}^i, \mathbf{X}^{i\top} | X_i] = \text{Cov}[\mathbf{X}^i, \mathbf{X}^{i\top}] - \text{Cov}[\mathbf{X}^i, X_i] \text{Cov}[X_i, \mathbf{X}^{i\top}] = \mathbf{P}^i - \boldsymbol{\rho}_i^i \boldsymbol{\rho}_i^{i\top} \quad (8.3.32)$$

This shows that (8.3.6) is valid. The formula (8.3.7) is derived in a similar way, see Fig. 8.2.

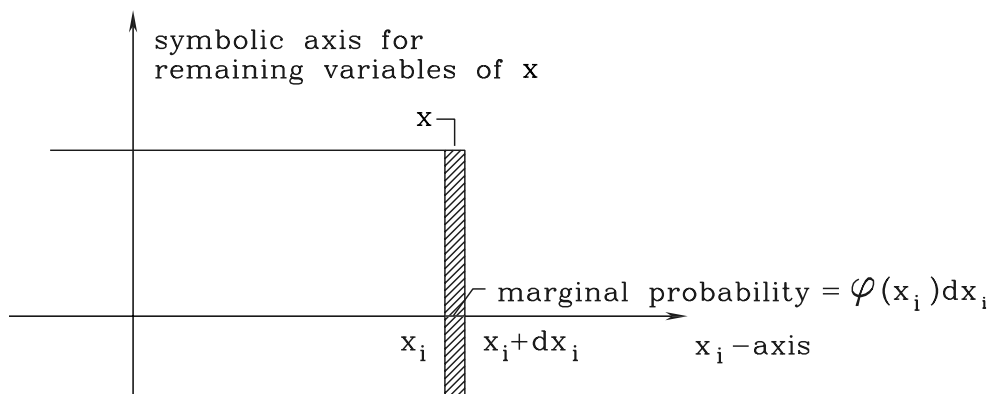

Figure 8.1: Drawing aiding the determination of $\partial \Phi_q(\mathbf{x}, \mathbf{P}) / \partial x_i$.

The second derivative with respect to x_i and x_j becomes

$$P(\mathbf{X} \leq \mathbf{x} | X_i = x_i, X_j = x_j) \varphi_2(x_i, x_j; \rho_{ij}) dx_i \quad (8.3.33)$$

The conditional probability is solely a function of \mathbf{x}^{ij} and it is the $(q-2)$ -dimensional normal distribution function corresponding to the mean value vector, see (4.3.4),

$$\begin{aligned} E[\mathbf{X}^{ij} | X_i, X_j] &= \text{Cov}[\mathbf{X}^{ij}, [X_i \ X_j]] \begin{bmatrix} 1 & \rho_{ij} \\ \rho_{ij} & 1 \end{bmatrix}^{-1} \begin{bmatrix} X_i \\ X_j \end{bmatrix} \\ &= \begin{bmatrix} \boldsymbol{\rho}_i^{ij} & \boldsymbol{\rho}_j^{ij} \end{bmatrix} \begin{bmatrix} 1 & \rho_{ij} \\ \rho_{ij} & 1 \end{bmatrix}^{-1} \begin{bmatrix} X_i \\ X_j \end{bmatrix} \end{aligned} \quad (8.3.34)$$

and the conditional covariance matrix, see (4.3.5),

$$\begin{aligned} &\text{Cov}[\mathbf{X}^{ij}, \mathbf{X}^{ij\top} | X_i, X_j] \\ &= \text{Cov}[\mathbf{X}^{ij}, \mathbf{X}^{ij\top}] - \text{Cov}[\mathbf{X}^{ij}, [X_i \ X_j]] \begin{bmatrix} 1 & \rho_{ij} \\ \rho_{ij} & 1 \end{bmatrix}^{-1} \text{Cov} \left[\begin{bmatrix} X_i \\ X_j \end{bmatrix}, \mathbf{X}^{ij\top} \right] \\ &= \mathbf{P}^{ij} - \begin{bmatrix} \boldsymbol{\rho}_i^{ij} & \boldsymbol{\rho}_j^{ij} \end{bmatrix} \begin{bmatrix} 1 & \rho_{ij} \\ \rho_{ij} & 1 \end{bmatrix}^{-1} \begin{bmatrix} \boldsymbol{\rho}_i^{ij} \\ \boldsymbol{\rho}_j^{ij} \end{bmatrix} \end{aligned} \quad (8.3.35)$$

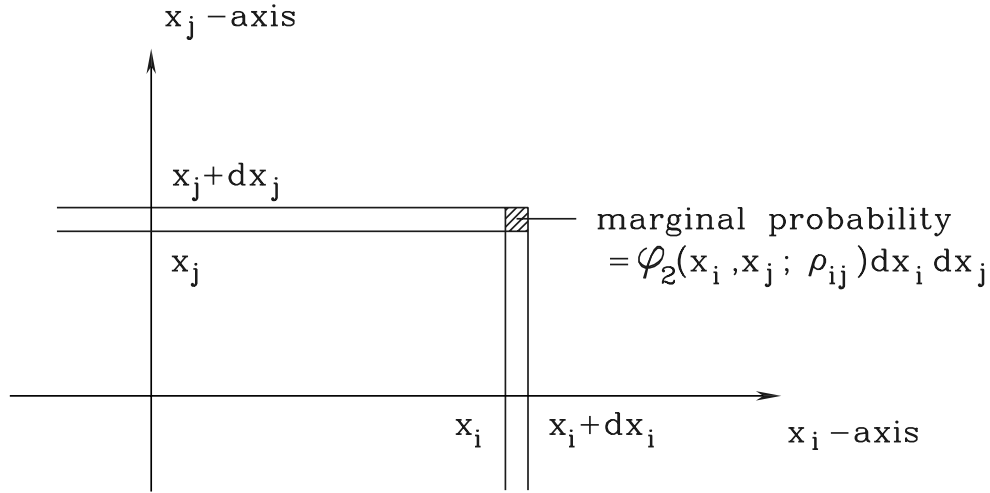

Figure 8.2: Drawing aiding the determination of $\partial^2 \Phi_q(\mathbf{x}; \mathbf{P}) / \partial x_i \partial x_j$.

This proves the right side of (8.3.7).

A proof of the identity

$$\frac{\partial \Phi_q(\mathbf{x}; \mathbf{P})}{\partial \rho_{ij}} = \frac{\partial^2 \Phi_q(\mathbf{x}; \mathbf{P})}{\partial x_i \partial x_j} \quad (8.3.36)$$

is given in [8.2], see also Exercise 4.3. □

8.4 Importance measures related to input parameters in series-system reliability*

For a series system the failure set is defined as in Section 6.6 by the union

$$\mathcal{F} = \bigcup_{i=1}^m \mathcal{F}_i \quad (8.4.1)$$

The situation is illustrated in Fig. 6.8. By multipoint FORM the failure probability $P(\mathcal{F})$ is approximated by

$$1 - P(M_1 > 0, \dots, M_m > 0) = 1 - P(-M_1 < 0, \dots, -M_m < 0) = 1 - \Phi_m(\boldsymbol{\beta}; \mathbf{P}) \quad (8.4.2)$$

where M_i is the linear safety margin corresponding to the tangent hyperplane at the globally most central point on the limit-state surface $\partial \mathcal{F}_i$. The corresponding simple reliability indices are collected in the vector $\boldsymbol{\beta} = (\beta_1, \dots, \beta_m)$ while $\mathbf{P} = \{\rho_{ij}\} = \{\boldsymbol{\alpha}'_i \boldsymbol{\alpha}_j\}$ is the correlation matrix of $\mathbf{M} = (M_1, \dots, M_m)$. The vector $\boldsymbol{\alpha}_i$ is the unit normal vector to the i th limit-state surface $\partial \mathcal{F}_i$ at the globally most central point on $\partial \mathcal{F}_i$.

The derivative of the right side of (8.4.2) with respect to an input parameter θ is

$$\frac{d[1 - \Phi_m(\boldsymbol{\beta}; \mathbf{P})]}{d\theta} = - \sum_{i=1}^m \left[-\frac{\partial \Phi_m}{\partial x_i} \frac{d\beta_i}{d\theta} + \sum_{j=1}^{i-1} \frac{\partial \Phi_m}{\partial \rho_{ij}} \frac{d\rho_{ij}}{d\theta} \right]_{\mathbf{x}=\boldsymbol{\beta}} \quad (8.4.3)$$

in which $d\rho_{ij}/d\theta$ is given by (8.3.27) and (8.3.28), and $d\beta_i/d\theta$ is given by (8.2.10). Once more it is emphasized that (8.3.28) is valid only under the assumption that all the limit-state functions g_k , $k \in \{1, \dots, m\}$, are defined such that $\|\nabla g_k\| = 1$ everywhere on the k th limit-state surface.

8.5 Historical and Bibliographical notes

The technique of the sensitivity analysis is as old as the differential calculus. In connection with reliability analysis its usefulness is pointed out in particular by H.O. Madsen who defined the omission sensitivity factor in 1988 [8.3].

It was shown by M. Hohenbichler in 1984 [8.1] that the generalized reliability index and the geometric reliability index asymptotically (in the same sense as in Section 6.4) have the same parameter sensitivity. For finite values of the geometric reliability index this asymptotic result is better, naturally, for almost plane limit state surfaces than, for example, for limit-state surfaces that correspond to parallel systems for which the globally most central point is in the intersection between the individual element limit-state surfaces.

This less accuracy of the asymptotic result for parallel systems motivated H.O. Madsen to derive the extensive explicit formulas in Section 8.3.

Bibliography

- [8.1] M. Hohenbichler (1984) *Mathematische Grundlagen der Zuverlässigkeitsmethode und einige Erweiterungen*. Berichte zur Zuverlässigkeitstheorie der Bauwerke, Heft 72, Technical University of Munich.
- [8.2] N.L. Johnson and S. Kotz (1972) *Distributions in Statistics: Continuous Multivariate distributions*, Wiley, New York.
- [8.3] H.O. Madsen (1988) Omission sensitivity factors. *Structural Safety*, **5**, 35-45.

This page is intentionally left blank.

Chapter 9

MONTE CARLO METHODS

9.1 Simulation principle

The technique of solving integration problems by Monte Carlo methods is based on the fact that the theory of probability among its several interpretations has the interpretation as a mathematical theory for the behavior of sample averages and the tendency of these to stabilize as the sample size increases. This interpretation is empirically well documented. This means that in place of solving a given integration problem by analytical or numerical mathematical methods it can be used that the integral can be interpreted as a mean value in a suitable stochastic experiment (see below) and that it therefore is possible to obtain a central estimate of the value of the integral by averaging a suitably large number of independent outcomes of this experiment. The accuracy of the estimate can be judged by use of standard statistical methods.

Probability theory itself predicts that the number of mutually independent outcomes often must be very large in order to obtain a sufficient accuracy by this empirical method that in its principle corresponds to gambling at the roulette in Monte Carlo. Therefore it has not been a realistic method of solution before after the development of fast computers. The mechanical roulette is replaced by an algorithm that programmed into the computer very quickly generates a sequence of so-called pseudo random numbers belonging to the interval $]0,1[$. The algorithm is based on a recursive mathematical formula and with some few starting numbers (called the seed, e.g. the first 3 elements of the sequence) all the following numbers of the sequence are generated. Thus the generating mechanism is completely deterministic. However, the applied mathematical formalism is constructed such that it generates results that show chaotic behavior. There are surprisingly many different simple algorithms that generate number sequences with chaotic behavior. It is a matter of experience that among these there are some that give number sequences with properties that are difficult to distinguish from the properties that the probability theory predicts are properties of sequences of mutually independent random numbers that are uniformly distributed between zero and one. The goodness of such a generator of random numbers is judged by subjecting the generated sequence to a series of statistical tests for independence and uniform distribution. There will always be a test that on the basis of a sufficiently long but finite part of the sequence can reveal that it is deterministically generated. This follows from a result in the theory of finite codes stating that it is possible even to reconstruct uniquely the mathematical generating mechanism solely on

the basis of a sufficiently long string of numbers from the sequence. Whether or not the generator is applicable for the solution of a given integration problem is thus a question about the robustness of the integral with respect to deviations from independence and uniformity. The problems for solution by Monte Carlo simulation using a given random number generator should therefore not be more sensitive to such deviations as the tests to which the generator has been put and has passed.

In the literature an over-optimistic faith is often seen about the truth of the results obtained by Monte Carlo simulation e.g. showing up by characterizing such results as being exact. However, for a given application it should always be considered whether the goodness of the generator is sufficient for the purpose. Generally the more strong test requirements the more complicated random number generator must be chosen with increased computation time as a consequence. For robust problems it is therefore rational to use a less good but simple generator while less robust problems require a more complicated generator. The software sold together with computers on the market often contains a random number generator that for many important applications is of insufficient quality. A well tested generator is given in [9.4].

As mentioned Monte Carlo methods aim at estimating the value of an integral of a given function $h(\mathbf{x})$ of $\mathbf{x} \in \mathbb{R}^n$ over a given subset $\mathcal{F} \subset \mathbb{R}^n$. Let \mathbf{Z} be an arbitrary n -dimensional random vector with a density function $f_{\mathbf{Z}}(\mathbf{z})$ which is positive everywhere in \mathcal{F} . We then have

$$\int_{\mathcal{F}} h(\mathbf{x}) d\mathbb{R}^n = \int_{\mathcal{F}} \frac{h(\mathbf{x})}{f_{\mathbf{Z}}(\mathbf{x})} f_{\mathbf{Z}}(\mathbf{x}) d\mathbb{R}^n = E \left[\mathbf{1}_{\mathbf{Z} \in \mathcal{F}} \frac{h(\mathbf{Z})}{f_{\mathbf{Z}}(\mathbf{Z})} \right] \quad (9.1.1)$$

where $d\mathbb{R}^n$ is short for the volume measure $\mathcal{L}(d\mathbb{R}^n)$ of the n -dimensional infinitesimal volume element $d\mathbb{R}^n$.

If we are able to generate a sample of mutually independent outcomes of the random variable $X = \mathbf{1}_{\mathbf{Z} \in \mathcal{F}} h(\mathbf{Z}) / f_{\mathbf{Z}}(\mathbf{Z})$, then the average of this sample will be a central estimator of the expectation (9.1.1), that is, for the value of the given integral. The less variation there is in the sample the faster a stable average is obtained. If, for example, $h(\mathbf{z})$ is positive everywhere in \mathcal{F} and the integral is finite, then the function $h(\mathbf{x}) \mathbf{1}_{\mathbf{Z} \in \mathcal{F}}$ is proportional to a density function. If \mathbf{Z} is chosen as the random vector with this density, then the random variable X will be a constant. Thus for a non-negative integrand in (9.1.1) it is possible by a suitable choice of the distribution of \mathbf{Z} in principle to get an arbitrarily small variation in the sample. However, the practical problem is to generate an outcome of \mathbf{Z} , and in general this limits the possible choices of distribution of \mathbf{Z} . The distribution of \mathbf{Z} will be called the *simulation distribution*.

In structural reliability the integration problem is relevant in connection with the determination of the failure probability

$$p_f = \int_{\mathcal{F}} f_{\mathbf{X}}(\mathbf{x}) d\mathbb{R}^n = \int_{\mathbb{R}^n} \mathbf{1}_{\mathbf{x} \in \mathcal{F}} f_{\mathbf{X}}(\mathbf{x}) d\mathbb{R}^n = E[\mathbf{1}_{\mathbf{x} \in \mathcal{F}}] \quad (9.1.2)$$

This formula may lead one to define $\mathbf{Z} = \mathbf{X}$, that is, to simulate outcomes of \mathbf{X} . Since p_f usually is extremely small, most of the outcomes of $\mathbf{1}_{\mathbf{x} \in \mathcal{F}}$ are 0, and only extremely rarely will the value 1 show up. It is obvious that such a simulation method functions very badly. Naturally it is much more appropriate to choose the simulation distribution such that the density is zero over as large parts of the safe set \mathcal{S} as possible while being positive everywhere in \mathcal{F} . Many different suggestions of simulation distributions can be found in the literature. The best of these choices are

supported on information from FORM or SORM analyses about where in \mathcal{F} the most essential contributions to the failure probability are located.

Here is not the place to treat the different suggested possibilities of intelligent Monte Carlo simulation. We will be content with a demonstration of a special procedure that has turned out to be quite effective to estimate small failure probabilities.

9.2 Directional simulation

Let us assume that the complementary set \mathcal{S} to the integration set \mathcal{F} in (9.1.1) has the property of being star shaped with respect to the zero point in a polar coordinate system. A set is said to be star shaped with respect to a point Q in the set itself if any half-line starting from Q intersects the boundary of the set in one and only one point (which may be in the infinite). Then we can in a simple way reduce the integral (9.1.1) in such a polar coordinate system to

$$\begin{aligned} \int_{\mathcal{F}} h(\mathbf{x}) d\mathbb{R}^n &= \int_{\text{unit sphere}} \left[\int_{r(\boldsymbol{\alpha})}^{\infty} \frac{h(s\boldsymbol{\alpha})}{f_{\mathbf{Z}}(s\boldsymbol{\alpha})} f_R(s|\boldsymbol{\alpha}) ds \right] f_{\mathbf{A}}(\boldsymbol{\alpha}) d\boldsymbol{\alpha} \\ &= E \left[\int_{r(\mathbf{A})}^{\infty} \frac{h(s\mathbf{A})}{f_{\mathbf{Z}}(s\mathbf{A})} f_R(s|\mathbf{A}) ds \right] \end{aligned} \quad (9.2.1)$$

where $\boldsymbol{\alpha}$ is the directional vector, $r(\boldsymbol{\alpha})$ is the radius vector in the direction of $\boldsymbol{\alpha}$ to the boundary $\partial\mathcal{F}$ of \mathcal{F} , while $f_R(s|\boldsymbol{\alpha})$ is the conditional density of R given $\mathbf{A} = \boldsymbol{\alpha}$, where R and \mathbf{A} are the radius vector component and the directional unit vector component, respectively, in the polar representation

$$\mathbf{Z} = R\mathbf{A} \quad (9.2.2)$$

of \mathbf{Z} . For the particular choice where \mathcal{F} is the failure set and $h(\mathbf{x}) = f_{\mathbf{X}}(\mathbf{x})$, the integral (9.2.1) is the failure probability p_f given in (9.1.2).

From (9.2.1) it is seen that we can apply a Monte Carlo method where in place of direct use of the simulated outcomes of \mathbf{Z} in (9.1.1) we use the simulated direction \mathbf{A} determined by the simulated outcome of \mathbf{Z} . We simply have that (9.2.2) gives

$$\mathbf{A} = \frac{\mathbf{Z}}{\|\mathbf{Z}\|} \quad (9.2.3)$$

where $\|\mathbf{Z}\| = R = \sqrt{Z_1^2 + \dots + Z_n^2}$. For the outcome $\boldsymbol{\alpha}$ of \mathbf{A} the value of the *simulation variable*

$$\int_{r(\boldsymbol{\alpha})}^{\infty} \frac{h(s\boldsymbol{\alpha})}{f_{\mathbf{Z}}(s\boldsymbol{\alpha})} f_R(s|\boldsymbol{\alpha}) ds \quad (9.2.4)$$

is next computed by a suitable numerical integration formula like the trapezium formula or, if possible, by a closed form solution of the integral.

Such a closed form formula exists for example if $h(\mathbf{x})$ is the n -dimensional standard normal density $\varphi_n(\mathbf{x})$, and the simulation distribution is chosen as the same distribution, see Fig. 9.1. Then R^2 is χ^2 -distributed with n degrees of freedom. Therefore the integral (9.2.4) reduces to

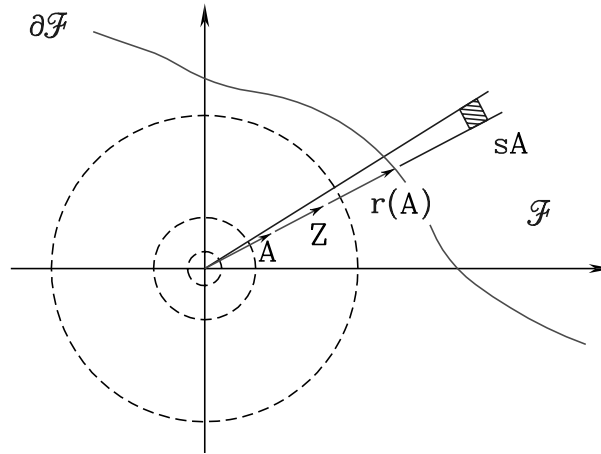

Figure 9.1: Uniform directional simulation.

$$\int_{r(\boldsymbol{\alpha})}^{\infty} f_R(s | \boldsymbol{\alpha}) ds = 1 - K_n[r(\boldsymbol{\alpha})^2] \tag{9.2.5}$$

where $K_n(\cdot)$ is the χ^2 -distribution function with n degrees of freedom. The following closed form formula is valid:

$$K_n(r^2) = \begin{cases} 1 - \exp\left(-\frac{r^2}{2}\right) \sum_{q=0}^{(n-2)/2} \frac{1}{q!} \left(\frac{r^2}{2}\right)^q & \text{for } n \text{ even} \\ 2\Phi(r) - 1 - \exp\left(-\frac{r^2}{2}\right) \sum_{q=0}^{(n-2)/2} \frac{1}{\Gamma[(2q+3)/2]} \left(\frac{r^2}{2}\right)^{(2q+1)/2} & \text{for } n \text{ odd} \end{cases} \tag{9.2.6}$$

Applied for estimation of small failure probabilities, the Monte Carlo directional simulation method based on (9.2.1) with an intelligently chosen sampling distribution avoids the problem which was obvious in connection with (9.1.2), namely that only very few of the simulated points would fall in \mathcal{F} . Contributions different from zero are obtained by directional simulation each time a finite value $r(\boldsymbol{\alpha})$ is obtained of the radius vector. For a direction $\boldsymbol{\alpha}$, where the boundary $\partial\mathcal{F}$ is in the infinite, we naturally get $r(\boldsymbol{\alpha}) = \infty$ implying that the integral (9.2.4) gives the sample value zero. In structural reliability analysis the failure set \mathcal{F} is often close to filling up a half-space. If the simulation distribution is chosen so that \mathbf{A} is uniformly distributed on the unit sphere it should be expected that an essential part of the outcomes will give $r(\boldsymbol{\alpha}) < \infty$.

It is left over to the reader to see that for each simulated direction $\boldsymbol{\alpha}$ also the opposite direction $-\boldsymbol{\alpha}$ can be used so that it will very frequently be the case that either $r(\boldsymbol{\alpha}) < \infty$ or $r(-\boldsymbol{\alpha}) < \infty$. It is emphasized that it is the average of the results from direction $\boldsymbol{\alpha}$ and direction $-\boldsymbol{\alpha}$ which should be taken as a single independent outcome in the sample. Further directions fixed relative to the simulated direction $\boldsymbol{\alpha}$ according to some rule can be included. This is treated in the literature [9.3,9.5].

However, the choice of the uniform distribution on the unit sphere as sampling distribution for \mathbf{A} is not particularly wise in case \mathcal{F} is like a half-space and the dimension n of the space is not very small. Even though most of the outcomes of $r(\mathbf{A})$ are finite they very frequently become

excessively large and the larger the dimension n of the space the larger they become. Except for small space dimensions use of uniform sampling on the unit sphere will create exactly the same problem as for direct Monte Carlo simulation based on (9.1.2), namely that most of the sample will consist of near zero values with only few significant values coming from the important region of \mathcal{F} around the most central point on $\partial\mathcal{F}$. See (9.3.26) for a proof of this fact.

Example 9.1 Let $\mathbf{X} = (X_1, \dots, X_n)$ be a Gaussian random vector. The sum

$$Y = \sum_{i=1}^n \max\{0, X_i\} \tag{9.2.7}$$

is used in Section 2.7 on load combinations. The distribution function of the sum can in a simple way be estimated by Monte Carlo directional simulation with uniform distribution of \mathbf{A} over the unit sphere in \mathbb{R}^n and use of (9.2.5) as simulation variable. For this, \mathbf{X} is first expressed by a standard normally distributed vector $\mathbf{U} = (U_1, \dots, U_n)$ through the linear substitution $\mathbf{X} = \mathbf{T}\mathbf{U} + \boldsymbol{\mu}$, where $\boldsymbol{\mu}$ is the mean value vector of \mathbf{X} and the matrix \mathbf{T} is determined from the covariance matrix $\text{Cov}[\mathbf{X}, \mathbf{X}^T]$. Let the i th row in \mathbf{T} be \mathbf{t}_i^T and let \mathbf{U} be given as the polar representation $\mathbf{U} = R\mathbf{A}$. Then we can write (9.2.7) as

$$Y = \sum_{i=1}^n \max\{0, \mathbf{t}_i^T \mathbf{A} R + \mu_i\} \tag{9.2.8}$$

The function

$$g(r | \boldsymbol{\alpha}) = \sum_{i=1}^n \max\{0, \mathbf{t}_i^T \mathbf{A} r + \mu_i\}, \quad r \in \mathbb{R} \tag{9.2.9}$$

is built as the sum of convex functions of r and it is therefore itself a convex function of r . This implies that the set

$$\{r \in \mathbb{R} | g(r | \boldsymbol{\alpha}) \leq y\} \tag{9.2.10}$$

is an interval $[r_1, r_2]$, see Fig. 9.2. If $r_1 \geq 0$ we have

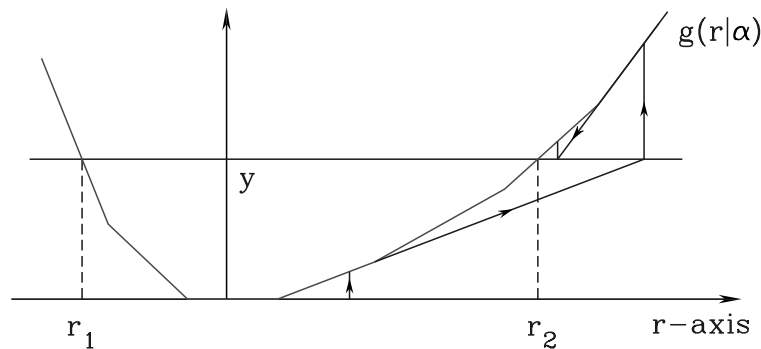

Figure 9.2: Graph of the convex function (9.2.9).

$$P(Y \leq y | \mathbf{A} = \boldsymbol{\alpha}) = K_n(r_2^2) - K_n(r_1^2), \quad P(Y \leq y | \mathbf{A} = -\boldsymbol{\alpha}) = 0 \quad (9.2.11)$$

If $r_1 < 0$ and $r_2 \geq 0$ we have

$$P(Y \leq y | \mathbf{A} = \boldsymbol{\alpha}) = K_n(r_2^2), \quad P(Y \leq y | \mathbf{A} = -\boldsymbol{\alpha}) = K_n(r_1^2) \quad (9.2.12)$$

If $r_2 < 0$ we have

$$P(Y \leq y | \mathbf{A} = \boldsymbol{\alpha}) = 0, \quad P(Y \leq y | \mathbf{A} = -\boldsymbol{\alpha}) = K_n(r_1^2) - K_n(r_2^2) \quad (9.2.13)$$

From this it follows that we generally have

$$\frac{1}{2}P(Y \leq y | \mathbf{A} = \boldsymbol{\alpha}) + \frac{1}{2}P(Y \leq y | \mathbf{A} = -\boldsymbol{\alpha}) = \frac{1}{2}\text{sign}(r_2)K_n(r_2^2) - \frac{1}{2}\text{sign}(r_1)K_n(r_1^2) \quad (9.2.14)$$

which according to the remark in parenthesis just above this example is our simulation variable when \mathbf{A} is simulated with uniform distribution on the unit sphere and we use both \mathbf{A} and $-\mathbf{A}$. We note that the event $\{Y \leq y\}$ not necessarily defines a star shaped set with respect to the origin in the standard Gaussian space (the space of \mathbf{U}). However, it has almost as simple a property namely that the radius vector at most intersects the boundary at two points. The assumption that the set \mathcal{S} should be star shaped is not essential. It only serves the purpose that the formulas in the presentation can be written as simple as possible. \square

Remark 9.1 To simulate outcomes of $\mathbf{A} = \mathbf{U}/\|\mathbf{U}\|$ we must be able to simulate outcomes of the n -dimensional standard Gaussian vector \mathbf{U} . Outcomes x of an arbitrary random variable X can always be generated by use of the formula

$$x = F_X^{-1}(y) \quad (9.2.15)$$

where y is an outcome of a random variable which is uniformly distributed over the interval $]0, 1[$. Such an outcome is obtained by use of a random number generator.

Occasionally it is faster to use another formula than (9.2.15). For example, it is possible to generate two mutually independent outcomes u_1, u_2 of a standard normal variable \mathbf{U} by use of the formulas

$$u_1 = \sqrt{-2\log y_1} \cos(2\pi y_2), \quad u_2 = \sqrt{-2\log y_1} \sin(2\pi y_2) \quad (9.2.16)$$

where y_1 and y_2 are mutually independent outcomes from the uniform distribution over $]0, 1[$. These formulas are derived directly from the polar representation for $n = 2$, since $P(R > r) = \exp[-\frac{1}{2}r^2]$, which according to (9.2.15) shows that an outcome of R can be generated as $\sqrt{-2\log y_1}$. \square

Example 9.2 Consider two subsums Y_1 and Y_2 of (9.2.7) and the corresponding subsums of (9.2.8). For each of these we can define functions $g_1(r | \boldsymbol{\alpha})$ and $g_2(r | \boldsymbol{\alpha})$ as in (9.2.9). Then

$$\{r \in \mathbb{R} | g_1(r | \boldsymbol{\alpha}) \leq y_1\} = [r_{11}, r_{12}], \quad \{r \in \mathbb{R} | g_2(r | \boldsymbol{\alpha}) \leq y_2\} = [r_{21}, r_{22}] \quad (9.2.17)$$

and thus that the intersection

$$\{r \in \mathbb{R} | g_1(r | \boldsymbol{\alpha}) \leq y_1, g_2(r | \boldsymbol{\alpha}) \leq y_2\} = [r_{11}, r_{12}] \cap [r_{21}, r_{22}] \quad (9.2.18)$$

is an interval $[r_1, r_2]$. Therefore we can estimate the distribution function

$$F_{Y_1, Y_2}(y_1, y_2) = P(Y_1 \leq y_1, Y_2 \leq y_2) \tag{9.2.19}$$

by uniform directional simulation by use of (9.2.14) as simulation variable.

Due to the piecewise linearity of the functions $g_1(r | \boldsymbol{\alpha})$ and $g_2(r | \boldsymbol{\alpha})$ it is possible also by directional simulation to obtain an estimate of the value of the distribution function of the difference $Y_1 - Y_2$ at an arbitrary point y . What is needed is just to determine the finitely many intervals in which $g_1(r | \boldsymbol{\alpha}) - g_2(r | \boldsymbol{\alpha}) \leq y$. \square

Example 9.3 Also the value of the density function for the sum (9.2.7) in Example 9.1 can be determined by Monte Carlo directional simulation. This is seen by differentiating the formula

$$F_Y(y) = E \left[\frac{1}{2} P(Y \leq y | \mathbf{A}) + \frac{1}{2} P(Y \leq y | -\mathbf{A}) \right] \tag{9.2.20}$$

with (9.2.14) substituted. We get

$$f_Y(y) = E[\text{sign}(r_2) k_n(r_2^2) r_2 r_2' - \text{sign}(r_1) k_n(r_1^2) r_1 r_1'] \tag{9.2.21}$$

where $k_n(\cdot)$ is the density function corresponding to the distribution function $K_n(\cdot)$, and where r_1' and r_2' are given by

$$r' = \frac{1}{\sum_{i \in J_r} \mathbf{t}'_i \mathbf{A}} \tag{9.2.22}$$

$$J_r = \{i | \mathbf{t}'_i \mathbf{A} + \mu_i > 0\} \tag{9.2.23}$$

for $r = r_1$ and r_2 , respectively. For $k_n(r^2)$ we have the closed form formula

$$k_n(r^2) = \frac{r^{n-2} \exp(-\frac{1}{2} r^2)}{2^{n/2} \Gamma(n/2)} \tag{9.2.24}$$

\square

9.3 A class of useful directional simulation distributions *

A useful class of directional simulation distributions is defined in the following. However, first we will explicitly give three examples from the class. These are characterized by the property that the generation of outcomes is simple. In the previous section we already considered the first of the examples. We list the examples with reference to (9.2.1):

1. \mathbf{Z} is standard Gaussian and centered at the origin, see Fig. 9.1:

$$f_{\mathbf{Z}}(s\mathbf{A}) \propto \exp(-s^2/2) \tag{9.3.1}$$

$$\int_{\mathcal{F}} h(\mathbf{x}) d\mathbb{R}^n = \frac{(2\pi)^{n/2}}{K} E \left[\int_{r(\mathbf{A})}^{\infty} h(s\mathbf{A}) s^{n-1} ds \right] \tag{9.3.2}$$

$$K = \Gamma(n/2) 2^{(n/2)-1} \tag{9.3.3}$$

For $h(\mathbf{x}) = \varphi_n(\mathbf{x})$ the simulation variable (9.2.5) is obtained.

2. \mathbf{Z} is standard Gaussian and centered at the point $\boldsymbol{\mu}$, see Fig. 9.3:

$$f_{\mathbf{Z}}(s\mathbf{A}) \propto \varphi_n(s\mathbf{A} - \boldsymbol{\mu}) \quad (9.3.4)$$

$$\int_{\mathcal{F}} h(\mathbf{x}) d\mathbb{R}^n = \frac{(2\pi)^{1/2}}{\varphi_n(\boldsymbol{\mu})} E \left[\frac{\varphi(\mathbf{A}^\top \boldsymbol{\mu})}{K(\mathbf{A}^\top \boldsymbol{\mu})} \int_{r(\mathbf{A})}^{\infty} h(s\mathbf{A}) s^{n-1} ds \right] \quad (9.3.5)$$

where $K(\mathbf{A}^\top \boldsymbol{\mu})$ is given by the function

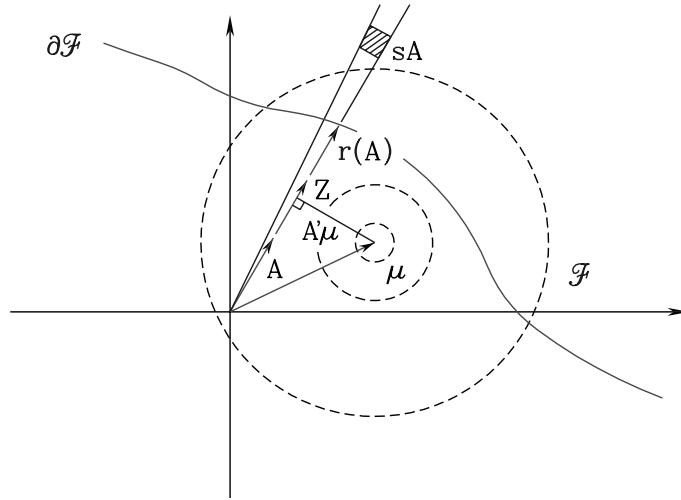

Figure 9.3: Illustration of the use of a simulation distribution which is standard Gaussian and centered at the point $\boldsymbol{\mu}$.

$$K(x) = \int_0^{\infty} s^{n-1} \exp \left[\frac{1}{2}(s-x)^2 \right] ds \quad (9.3.6)$$

with $K(0) = K$ given by (9.3.3). For $h(\mathbf{x}) = \varphi_n(\mathbf{x} - \boldsymbol{\mu})$ we get

$$\int_{\mathcal{F}} \varphi_n(\mathbf{x} - \boldsymbol{\mu}) d\mathbb{R}^n = E[1 - F_R[r(\mathbf{A}) | \mathbf{A}]] \quad (9.3.7)$$

where the conditional distribution function $F_R[x | \boldsymbol{\alpha}]$ can be determined by an algorithm which is recursive in n , see Remark 9.2.

Remark 9.2 The integral

$$I_{n-1}(x, y) = \int_x^{\infty} s^{n-1} \exp \left(-\frac{1}{2}(s-y)^2 \right) ds \quad (9.3.8)$$

can by integration by parts be written as

$$\begin{aligned} I_{n-1}(x, y) &= \left[\frac{1}{n} s^n \exp \left(-\frac{1}{2}(s-y)^2 \right) \right]_x^{\infty} + \frac{1}{n} \int_x^{\infty} (s-y) s^n \exp \left(-\frac{1}{2}(s-y)^2 \right) ds \\ &= \frac{1}{n} \left[-x^n \exp \left(-\frac{1}{2}(x-y)^2 \right) + I_{n+1}(x, y) - y I_n(x, y) \right] \end{aligned} \quad (9.3.9)$$

such that we have the recursive formula

$$I_{n+1}(x, y) = nI_{n-1}(x, y) + yI_n(x, y) + x^n \exp\left(-\frac{1}{2}(x - y)^2\right) \quad (9.3.10)$$

It is directly obtained that

$$I_0(x, y) = \sqrt{2\pi}\Phi(y - x) \quad (9.3.11)$$

$$I_1(x, y) = \sqrt{2\pi}\Phi(y - x)y + \exp\left(-\frac{1}{2}(x - y)^2\right) \quad (9.3.12)$$

The function in (9.3.6) is given by

$$K(x) = I_{n-1}(0, x) \quad (9.3.13)$$

while the complementary conditional distribution function in (9.3.7) is

$$1 - F_R[x | \boldsymbol{\alpha}] = \frac{I_{n-1}(x, \boldsymbol{\alpha}^\top \boldsymbol{\mu})}{I_{n-1}(0, \boldsymbol{\alpha}^\top \boldsymbol{\mu})} \quad (9.3.14)$$

□

3. \mathbf{Z} is mixed standard Gaussian and half space truncated standard Gaussian, see Fig. 9.4:

$$f_{\mathbf{Z}}(s\mathbf{A}) = p\varphi_n(s\mathbf{A}) + (1 - p)\varphi_{\text{tr}}(s\mathbf{A}; \mathbf{v}, d) \quad (9.3.15)$$

where p is the mixing probability and

$$\varphi_{\text{tr}}(\mathbf{x}; \mathbf{v}, d) = \frac{\varphi_n(\mathbf{x})}{\Phi(-d)} \mathbf{1}_{\mathbf{x}^\top \mathbf{v} > d} \quad (9.3.16)$$

is the half space truncated standard Gaussian density corresponding to the truncation hyperplane defined by the normal unit vector \mathbf{v} and the distance d from the origin.

$$\int_{\mathcal{F}} h(\mathbf{x}) d\mathbb{R}^n = (2\pi)^{n/2} \frac{\Phi(-d)}{K} E \left[\frac{\int_{r(\mathbf{A})}^{\infty} h(s\mathbf{A}) s^{n-1} ds}{p\Phi(-d) + (1 - p) \left(1 - K_n \left[\left(\frac{d}{\|\mathbf{A}\|} \right)^2 \right] \right) \mathbf{1}_{\mathbf{x}^\top \mathbf{v} > d}} \right] \quad (9.3.17)$$

with K given by (9.3.3) and $K_n(\cdot)$ given by (9.2.6). For $h(\mathbf{x}) = \varphi_n(\mathbf{x})$ in particular:

$$\int_{\mathcal{F}} \varphi_n(\mathbf{x}) d\mathbb{R}^n = \Phi(-d) E \left[\frac{1 - K_n[r(\mathbf{A})^2]}{p\Phi(-d) + (1 - p) \left(1 - K_n \left[\left(\frac{d}{\|\mathbf{A}\|} \right)^2 \right] \right) \mathbf{1}_{\mathbf{x}^\top \mathbf{v} > d}} \right] \quad (9.3.18)$$

On the basis of Remark 9.1 the generation of outcomes from the simulation densities (9.3.1) and (9.3.4) are without problems. For the simulation density (9.3.15) outcomes are generated in more steps. First the draw of a random number determines from which population of the two in the mix the generation should be made. A draw from the half space truncated standard Gaussian density is made by first generating an outcome of an n -dimensional standard Gaussian vector \mathbf{U}

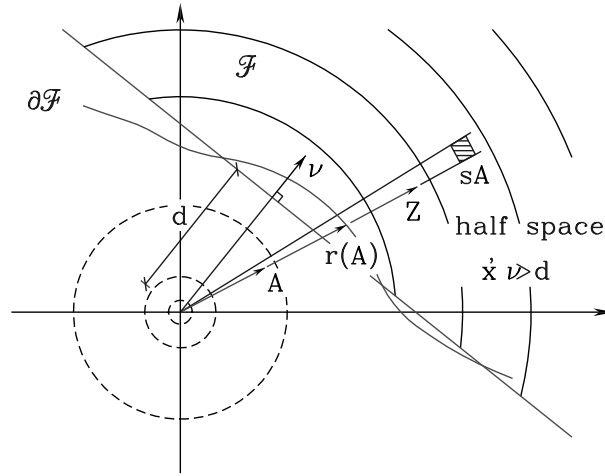

Figure 9.4: Illustration of the use of a simulation distribution which is mixed standard Gaussian and half space truncated standard Gaussian.

and then projecting this vector onto the hyperplane through the origin parallel to the truncation hyperplane. Thereby an outcome of the singular n -dimensional Gaussian vector $\mathbf{U} - (\mathbf{v}^\top \mathbf{U})\mathbf{v}$ is obtained. Now adding $W\mathbf{v}$, we get

$$\mathbf{Z} = \mathbf{U} + (W - \mathbf{v}^\top \mathbf{U})\mathbf{v} \quad (9.3.19)$$

where W is a random variable with the truncated Gaussian complementary distribution function

$$\bar{F}_W(x) = \frac{\Phi(-x)}{\Phi(-d)}, \quad x \geq d \quad (9.3.20)$$

These three examples belong to the class of mixed distributions between a standard Gaussian distribution and a \mathcal{D} -truncated standard Gaussian distribution both centred at the point $\boldsymbol{\mu}$. The symbol \mathcal{D} stands for a subset of \mathbb{R}^n . In the third example \mathcal{D} is a half space while $\mathcal{D} = \mathbb{R}^n$ in the two first examples. We have

$$f_{\mathbf{Z}}(s\mathbf{A}) = \varphi_n(s\mathbf{A} - \boldsymbol{\mu}) \left[p + (1-p) \frac{\mathbf{1}_{s\mathbf{A} \in \mathcal{D}}}{\int_{\mathcal{D}} \varphi_n(\mathbf{x} - \boldsymbol{\mu}) d\mathbb{R}^n} \right] \quad (9.3.21)$$

$$\int_{\mathcal{F}} h(\mathbf{x}) d\mathbb{R}^n = \frac{\sqrt{2\pi}}{\varphi_n(\boldsymbol{\mu})} \int_{\mathcal{D}} \varphi_n(\mathbf{x} - \boldsymbol{\mu}) d\mathbb{R}^n \cdot E \left[\frac{\varphi(\mathbf{A}^\top \boldsymbol{\mu}) \int_{r(\mathbf{A})}^{\infty} h(s\mathbf{A}) s^{n-1} ds}{pK(\mathbf{A}^\top \boldsymbol{\mu}) \int_{\mathcal{D}} \varphi_n(\mathbf{x} - \boldsymbol{\mu}) d\mathbb{R}^n + (1-p) \int_0^{\infty} \mathbf{1}_{s\mathbf{A} \in \mathcal{D}} s^{n-1} \exp(-\frac{1}{2}(s - \mathbf{A}^\top \boldsymbol{\mu})^2) ds} \right] \quad (9.3.22)$$

Besides depending on the possibility of fast simulation of outcomes of $\mathbf{A} = \mathbf{Z}/\|\mathbf{Z}\|$ the appropriateness of applying the Monte Carlo directional simulation technique to determine an estimate

for the expectation in (9.3.22) depends on the calculations that are needed to obtain the values of the integrals

$$\int_{r(\mathbf{A})}^{\infty} h(s\mathbf{A})s^{n-1} ds \tag{9.3.23}$$

$$\int_0^{\infty} \mathbf{1}_{s\mathbf{A} \in \mathcal{D}} s^{n-1} \exp\left(-\frac{1}{2}(s - \mathbf{A}^T \boldsymbol{\mu})^2\right) ds \tag{9.3.24}$$

for each outcome of \mathbf{A} . If closed form formulas are not available for these integrals, numerical integration can be applied. Moreover the value of the integral

$$\int_{\mathcal{D}} \varphi_n(\mathbf{x} - \boldsymbol{\mu}) d\mathbb{R}^n \tag{9.3.25}$$

must be known. A separate Monte Carlo integration can be applied to get a sufficiently accurate value.

Examples of more general truncation sets \mathcal{D} than half spaces are studied in the literature [9.2,9.7]. However, for limit state problems in spaces of high dimension it is very difficult to construct an efficient sampling distribution if the position of the most important part of the failure set is not located. As an example consider a failure set of which the most important part is a subset of the circular cone $\{\mathbf{x} \in \mathbb{R}_+ : \sum_{i=2}^n x_i^2 < x_1^2 \tan^2 \gamma\}$ of top angle γ with the x_1 -axis. The probability content of the cone is

$$\int_0^{\infty} P\left(\sum_{i=2}^n X_i^2 \leq x^2 \tan^2 \gamma\right) \varphi(x) dx = \int_0^{\infty} K_{n-1}(x^2 \tan^2 \gamma) \varphi(x) dx < K_{n-1}(x_0^2 \tan^2 \gamma) + \Phi(-x_0) \tag{9.3.26}$$

for any $x_0 > 0$. For any $\epsilon > 0$ we can choose x_0 so that $\Phi(-x_0) < \epsilon/2$ and thereupon an integer N so that $K_{n-1}(x_0^2 \tan^2 \gamma) < \epsilon/2$ for $n > N$, see 6.1.7. Thus, irrespective of the size of the angle $\gamma < \pi/2$, the probability of hitting the failure set by uniform directional sampling becomes increasingly small for increasing dimension n of the space.

The situation is different if the globally most central point on the limit state surface is known. Then directional importance sampling can be effective for improving the known FORM estimate of the probability of failure. For checking the accuracy of the zero-order model correction method described in Section 7.6, uniform directional simulation on the surface of a cone can be applied as described in Section 11.5.

Example 9.4 The frame structure in Fig. 6.7 is considered. The yield moments Y_1, \dots, Y_n are assumed to be mutually independent random variables with a common log-normal distribution. We will here be content with studying the mechanism in the lower left corner of Fig. 6.7. The plastic dissipation is $D = Y_1 + 2Y_3 + 2Y_4 + Y_5$, while the corresponding external work is $w = Fa + Gb$. The probability of collapse is obviously equal to $P(D \leq w) = F_D(w)$. It is convenient to express the yield moments and the external work in a unit which equals the common mean value of the yield moments. Thus we put this mean value to 1 and introduce the normalized variables $X_1 = (Y_1 - 1)/\gamma$, $X_2 = (Y_3 - 1)/\gamma, \dots, X_4 = (Y_5 - 1)/\gamma$, where γ is the common coefficient of variation of the yield moments. Thereby the dissipation can be written as

$$D = \gamma(X_1 + 2X_2 + 2X_3 + X_4) + 6 \tag{9.3.27}$$

The simple reliability index corresponding to the linear safety margin $D - w$ is thus

$$\beta = \frac{6 - w}{\gamma\sqrt{10}} \quad (9.3.28)$$

As an example let $\gamma = 0.25$ and $\beta = 3.1$, such that $w = 3.55$. For these values it turns out that Monte Carlo directional simulation gives a value of the generalized reliability index close to 4.0. Due to the lognormal distribution and the rather large coefficient of variation the simple reliability index thus undervalues the safety significantly as compared to the generalized reliability index.

The failure set corresponding to the event $D \leq w$ is the part of the set $\{\mathbf{x} \in \mathbb{R}^4 \mid \gamma x_1 > -1, \dots, \gamma x_4 > -1\}$ that is situated below the hyperplane

$$H: \gamma(x_1 + 2x_2 + 2x_3 + x_4) + 6 - w = 0 \quad (9.3.29)$$

Guided by this we will choose a simulation distribution which is a \mathcal{D} -truncated standard Gaussian distribution centered at a point $\boldsymbol{\mu} \in H$, where \mathcal{D} is the half space situated below the hyperplane H . Therefore the formula (9.3.22) applies with $p = 0$, $n = 4$ and

$$\int_{\mathcal{D}} \varphi_n(\mathbf{x} - \boldsymbol{\mu}) d\mathbb{R}^n = \frac{1}{2} \quad (9.3.30)$$

and, see Example 7.1,

$$h(\mathbf{x}) = \prod_{i=1}^4 \left[\frac{\gamma}{(1 + \gamma x_i) \sqrt{\log(1 + \gamma^2)}} \varphi \left(\frac{\log[(1 + \gamma x_i) \sqrt{1 + \gamma^2}]}{\sqrt{\log(1 + \gamma^2)}} \right) \right] \quad (9.3.31)$$

We get

$$F_D(w) = \frac{1}{2} (2\pi)^{n/2} \exp\left(\frac{1}{2} \|\boldsymbol{\mu}\|^2\right) E \left[\frac{\exp\left[-\frac{1}{2}(\mathbf{A}^\top \boldsymbol{\mu})^2\right] \int_{r_1(\mathbf{A})}^{r_2(\mathbf{A})} h(s\mathbf{A}) s^{n-1} ds}{\int_{r_1(\mathbf{A})}^{\infty} s^{n-1} \exp\left(-\frac{1}{2}(s - \mathbf{A}^\top \boldsymbol{\mu})^2\right) ds} \right] \quad (9.3.32)$$

where $r_1(\mathbf{A})$ is the radius vector to H in the direction \mathbf{A} , while $r_2(\mathbf{A})$ is the radius vector to the boundary of the set $\{\mathbf{x} \in \mathbb{R}^4 \mid \gamma x_1 > -1, \dots, \gamma x_4 > -1\}$. The normal unit vector to H is $\boldsymbol{\mu} = -(1, 2, 2, 1)/\sqrt{10}$, while the distance from the zero point to H is $d = \beta$, (9.3.28). Thus we have

$$r_1(\boldsymbol{\alpha}) = \frac{d}{\mathbf{v}^\top \boldsymbol{\alpha}} = \frac{6 - w}{\gamma(-\alpha_1 - 2\alpha_2 - 2\alpha_3 - \alpha_4)} \quad (9.3.33)$$

$$r_2(\boldsymbol{\alpha}) = \frac{1}{\gamma} \min \left\{ \frac{1}{-\alpha_1}, \frac{1}{-\alpha_2}, \frac{1}{-\alpha_3}, \frac{1}{-\alpha_4} \right\} \quad (9.3.34)$$

A suitable choice of $\boldsymbol{\mu} \in H$ is the point $\mathbf{v}d \in H$ closest to the origin. For each generated outcome $\boldsymbol{\alpha}$ of \mathbf{A} the integral in the numerator in (9.3.32) is computed by use of the trapezium rule, while the denominator can be computed by use of the formula given in Remark 9.2. Here we will not make considerations about the accuracy of the numerical integration but just refer to [9.7]. The curve in full line in the diagram in the upper left corner of Fig. 9.5 shows the development of the estimate of $F_D(3.55)$ with increasing sample size. The two dotted curves give the boundaries of the 95% confidence interval estimated from the sample. By this we get an impression of the

accuracy that is achieved by the simulation. For large sample sizes asymptotic normal distribution theory can be applied as the basis for this accuracy evaluation. It is seen that $F_D(3.55) \approx 3.0 \cdot 10^{-5}$, which corresponds to the generalized reliability index $\beta_G = 4.011$. During the solution of practical integration problems such a diagram should always be made because it is noted that the results only get a reasonable stability for suitably large sample sizes. In practice it is extremely difficult by theoretical means to predict a sufficient sample size for achieving a reliable result. One of the reasons is that the distribution of the complicated simulation variable usually is unknown. The sample size should therefore be sufficiently large for asymptotic normal distribution theory to be applicable. However, what can be termed as sufficient depends on the distribution of the simulation variable.

Now one can raise the question whether another choice of $\boldsymbol{\mu} \in H$ than $\boldsymbol{\nu}d$ will give a smaller variation in the sample. By using the information that is obtained currently as the simulation proceeds it is possible to improve the choice of $\boldsymbol{\mu}$. As indicator we can use the sequence of simulated sample values $S_1, S_2, \dots, S_i, \dots$, where S_i is the sample value obtained by the i th simulation. In each step it is controlled whether $S_i > S_{\max} = \max\{S_1, S_2, \dots, S_{i-1}\}$. If this is the case the point $\boldsymbol{\mu}$ is changed to

$$\boldsymbol{\mu} = \boldsymbol{\alpha}_i r(\boldsymbol{\alpha}_i) \quad (9.3.35)$$

in the continued simulation. If $S_i \leq S_{\max}$ the point $\boldsymbol{\mu}$ is kept unchanged. Thus it is achieved that the central part of the simulation distribution, after the lapse of some simulation time, will be placed such that the directions that contribute the most to the integral also will be drawn the most frequent. This strategy is supported on intuition and is based on the same principles as those behind FORM and SORM. However, no proof is given that this procedure represents the best strategy under the given restrictions. These are that $\boldsymbol{\mu} \in H$, and that the truncation half space of the simulation distribution is kept fixed with H as the boundary hyperplane. More generally, more parameters that define the simulation distribution can naturally be changed during the simulation.

The curve shown in the lower left corner of Fig. 9.5 is obtained by use of this updating strategy. Except in the beginning of the simulation run there is no drastic difference in behavior as compared to the results obtained without updating as shown in the upper left corner diagram. For a given sample size, the standard deviation obtained in the method with updating is found to be about 83% of the standard deviation obtained without updating. A comparison of the standard deviations obtained for the same sample size gives, however, an incorrect measure of the relative effectivity of the two procedures. The computation time should also be included in the comparison. A definition of a reciprocal effectivity measure with reasonable properties is

$$\text{reciprocal effectivity} = V(N) \sqrt{T(N)} \quad (9.3.36)$$

where $T(N)$ is the computation time corresponding to the sample size N and $V(N)$ is a particular coefficient of variation defined by

$$V(N) = \sqrt{\frac{\sum_{i=1}^N (S_i - \bar{S})^2}{N(N-1)}} \cdot \begin{cases} \frac{1}{\bar{S}} & \text{for } \bar{S} \leq 0.5 \\ \frac{1}{1-\bar{S}} & \text{for } \bar{S} > 0.5 \end{cases} \quad (9.3.37)$$

where

$$\bar{S} = \frac{1}{N} \sum_{i=1}^N S_i \quad (9.3.38)$$

The reciprocal effectivity is asymptotically independent of the sample size N and thus also of the computation time $T(N)$ for $N \rightarrow \infty$. Of course it depends on the applied computer and of the effectivity of the program. Applied to the same computer the reciprocal effectivity is therefore well suited for comparisons of two different simulation programs for the same problem.

For the two considered simulations without and with updating of the reciprocal effectivity is computed to be 1.32 and 1.11, respectively. The updating thus improves the reciprocal effectivity with a factor of 0.84.

The problem in this example has also been solved by first transforming the problem into the standard Gaussian space. In this space a uniform directional simulation is thereafter made in the same way as in Example 9.1 (using both \mathbf{A} and $-\mathbf{A}$). This simulation has given the diagram to the right in Fig. 9.5. It is seen that the standard deviation for a given sample size is about 4 times larger than in the diagram in the lower left corner. This convincingly illustrates the effect of intelligent choice of the simulation distribution. However, as emphasized above we should not use this comparison but instead compute the reciprocal effectivity. It is found to be 1.88. From this method with uniform directional simulation in the standard Gaussian space to the considered intelligent directional simulation with updating the improvement of the reciprocal effectivity is thus only by a factor of 0.59.

General conclusions cannot be drawn from this example. Due to the lognormal distribution and the independence, the transformation to the standard Gaussian space is very simple. The extremely simple radius vector determinations (9.3.33) and (9.3.34), however, are replaced by the more time consuming determination of $r(\mathbf{A})$ by a suitable iterative solution procedure. On the other hand, the closed form formula (9.2.7) for the simulation variable can be an advance as compared to the numerical integration needed for the use of (9.3.32). \square

9.4 Sensitivity factors*

Assume that the integration domain \mathcal{F} depends on a parameter θ , and write \mathcal{F} as $\mathcal{F}(\theta)$. The derivative of (9.3.22) with respect to θ then becomes

$$\begin{aligned} & \frac{\partial}{\partial \theta} \int_{\mathcal{F}(\theta)} h(\mathbf{x}) d\mathbb{R}^n \\ &= \frac{\sqrt{2\pi}}{\varphi_n(\boldsymbol{\mu})} \int_{\mathcal{D}} \varphi_n(\mathbf{x} - \boldsymbol{\mu}) d\mathbb{R}^n E \left[\frac{-\varphi(\mathbf{A}^\top \boldsymbol{\mu}) h[r(\mathbf{A})\mathbf{A}] r(\mathbf{A})^{n-1} \frac{\partial r(\mathbf{A})}{\partial \theta}}{\text{same denominator as in (9.3.22)}} \right] \end{aligned} \quad (9.4.1)$$

where $\partial r(\mathbf{A})/\partial \theta$ is obtained by implicit differentiation of the equation $G(\mathbf{x}; \theta) = 0$ for the boundary $\partial \mathcal{F}(\theta)$ with \mathbf{x} put to $\mathbf{x} = r(\mathbf{A})\mathbf{A}$. This gives

$$\left(\sum_{i=1}^n \frac{\partial G}{\partial x_i} A_i \right) \frac{\partial r(\mathbf{A})}{\partial \theta} + \frac{\partial G}{\partial \theta} = 0 \quad (9.4.2)$$

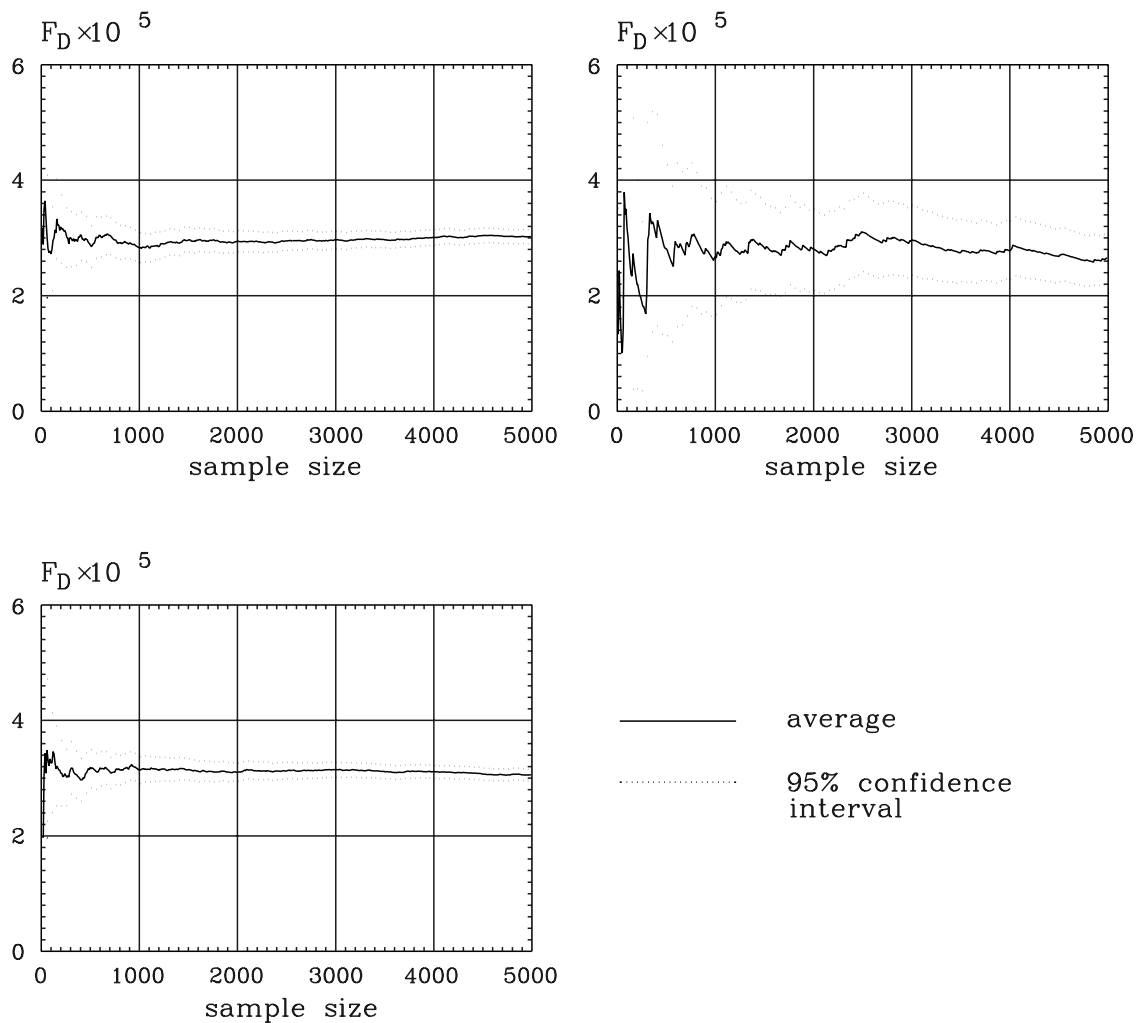

Figure 9.5: Simulation realization of the sample average as function of the sample size for the simulation variables that are constructed with the purpose of estimating the distribution function value $F_D(w)$ for $w = 3.55$ (Example 9.4). The diagrams to the left correspond to a simulation distribution which is a half space truncated ($\{D \leq w\}$) standard Gaussian distribution centered at $\boldsymbol{\mu} \in H$ ($H = \{D = w\}$). In the upper diagrams the point $\boldsymbol{\mu}$ has been kept fixed at the projection of the origin onto H and in the lower diagram $\boldsymbol{\mu} \in H$ has been successively updated. The inverse effectivities are 1.32 and 1.11, respectively. The diagram to the right corresponds to uniform directional simulation in the standard Gaussian space obtained by transformation. The inverse effective has been determined to be 1.88.

or

$$\frac{\partial r(\mathbf{A})}{\partial \theta} = \left[\frac{-\partial G / \partial \theta}{\nabla G^T \mathbf{A}} \right]_{\mathbf{x}=r(\mathbf{A})\mathbf{A}} \tag{9.4.3}$$

Thus the sensitivity of the integral (9.3.22) with respect to θ can be determined by the same directional simulation as the integral itself. Only the simulation variable has been changed to the variable defined in (9.4.1). Earlier this principle has been applied in Example 9.3 for density

function determination.

Assume that instead of the integration domain \mathcal{F} it is the integrand $h(\mathbf{x})$ that depends on a parameter θ , and let us write $h(\mathbf{x})$ as $h(\mathbf{x}, \theta)$. Then (9.3.22) gives

$$\begin{aligned} & \frac{\partial}{\partial \theta} \int_{\mathcal{F}} h(\mathbf{x}, \theta) d\mathbb{R}^n \\ &= \frac{\sqrt{2\pi}}{\varphi_n(\boldsymbol{\mu})} \int_{\mathcal{D}} \varphi_n(\mathbf{x} - \boldsymbol{\mu}) d\mathbb{R}^n E \left[\frac{\varphi(\mathbf{A}^\top \boldsymbol{\mu}) \int_{r(\mathbf{A})}^{\infty} \partial h(s\mathbf{A}; \theta) / \partial \theta s^{n-1} ds}{\text{same denominator as in (9.3.22)}} \right] \end{aligned} \quad (9.4.4)$$

where in general as in (9.3.22) numerical integration is applied for each simulated outcome of \mathbf{A} .

Example 9.5 The density function $f_D(w)$ of the random variable D in Example 9.4 is obtained by differentiation of (9.3.32) with respect to w solely through $r(\mathbf{A})$ (corresponding to (9.4.1) with $\theta = w$). All other dependencies of w are kept constant because it is only the limit state hyperplane that should be varied with w and not the truncation hyperplanes for the simulation distribution. We get

$$\begin{aligned} f_D(w) &= \frac{1}{2} (2\pi)^{n/2} \exp\left(\frac{1}{2} \|\boldsymbol{\mu}\|^2\right) \frac{(6-w)^{n-1}}{(\gamma\sqrt{10})^n} \\ &\cdot E \left[\frac{\exp\left[-\frac{1}{2}(\mathbf{A}^\top \boldsymbol{\mu})^2\right] h\left(\frac{d}{\mathbf{v}^\top \mathbf{A}}\right)}{(\mathbf{v}^\top \mathbf{A})^n \int_{d/\mathbf{v}^\top \mathbf{A}}^{\infty} s^{n-1} \exp\left(-\frac{1}{2}(s - \mathbf{A}^\top \boldsymbol{\mu})^2\right) ds} \right] \end{aligned} \quad (9.4.5)$$

Fig. 9.6 shows in the upper diagram the curve obtained for $f_D(w)$ as a function of the sample size when the computation is made by use of the same simulations that were used to produce the lower diagram in Fig. 9.5. The reciprocal effectivity is found to 0.95, noting that this corresponds to simultaneous computation of $F_D(w)$, for which the reciprocal effectivity was determined to 1.11. If updating is made under the use of the simulation variable in (9.4.5) the lowest two diagrams in Fig. 9.6 are obtained for $F_D(w)$ and $f_D(w)$. The two reciprocal effectivities become 1.16 and 1.01, respectively. By exclusively computing $f_D(w)$ a reciprocal effectivity of 0.21 is obtained. \square

9.5 Historical and bibliographical notes

With the development of fast computers the simulation methods have become very popular as tools for computation of failure probabilities. On simulation in general can be referred to R.Y. Rubinstein [9.11]. Applications in the structural reliability analysis have been given by G. Augusti et al [9.1], A. Harbitz [9.8], M. Hohenbichler and R. Rackwitz [9.9], R.E. Melchers [9.10], M. Shinozuka [9.12], G.I. Schuëller et al [9.13] among many other researchers.

The particular directional simulation method described in the previous sections was first used by I. Deák in 1980 [9.3] for the computation of distribution function values in the n -dimensional normal distribution. The possibilities of the method in structural reliability was pointed out to O. Ditlevsen by A.M. Hasofer in 1984 with several publications of O. Ditlevsen et al as a result [9.4-7]. Contributions to this development are also given by P. Bjerager [9.2] and by R.E. Melchers some of which in cooperation with O. Ditlevsen et al [9.7].

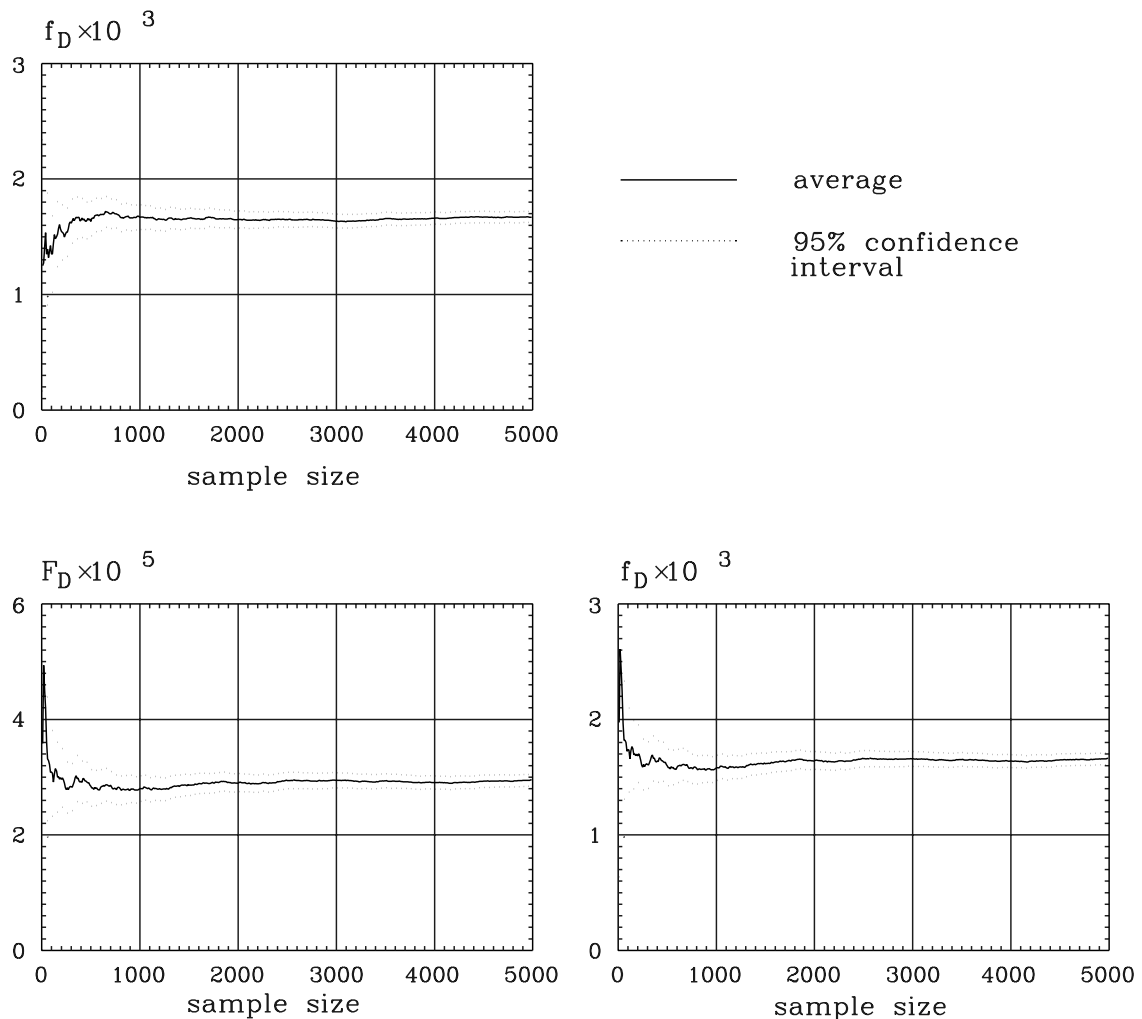

Figure 9.6: Simulation realizations for both the distribution function value $F_D(w)$ and the density function value $f_D(w)$ for $w = 3.55$, see Example 9.5.

Bibliography

- [9.1] G. Augusti, A. Baratta and F. Casciati (1984) *Probabilistic Methods in Structural Engineering*. Chapman & Hall, London.
- [9.2] P. Bjerager (1988) Probability integration by directional simulation. *Journal of Eng. Mech.*, ASCE, **114**, 1285-1302.
- [9.3] I. Deák (1980) Three digit accurate multiple normal probabilities. *Numerische Mathematik*, **35**, 369-380.
- [9.4] O. Ditlevsen, R. Olesen and G. Mohr (1987) Solution of a class of load combination problems by directional simulation. *Structural Safety*, **4**, 95-109.
- [9.5] O. Ditlevsen, P. Bjerager, R. Olesen, and A.M. Hasofer (1988) Directional simulation in Gaussian processes. *Probabilistic Engineering Mechanics*, **3**, 207-217.

- [9.6] O. Ditlevsen and P. Bjerager (1989) Plastic reliability analysis by directional simulation. *Journal of Eng. Mech.*, ASCE, **115**,1347-1362.
- [9.7] O. Ditlevsen, R.E. Melchers, and H. Gluwer (1990) General multi-dimensional probability integration by directional simulation. *Computers and Structures*, **36**, 355-368.
- [9.8] A. Harbitz (1983) Efficient and accurate probability of failure calculation by the use of importance sampling. In: *Proc. of 4th Int. Conf. on Appl. of Statistics and Probability in Soil and Structural Eng.* (ICASP 4). Pitagora Editrice, Bologna, Italy, 825-836.
- [9.9] M. Hohenbichler and R. Rackwitz (1988) Improvement of second-order reliability estimates by importance sampling. *Journal of Eng. Mech.*, ASCE, **114**, 2195-2199.
- [9.10] R.E. Melchers (1987) *Structural Reliability and Predictions*. Ellis Horwood/Wiley, Chichester.
- [9.11] R.Y. Rubinstein (1981) *Simulation and the Monte-Carlo Method*. Wiley, New York.
- [9.12] M. Shinozuka (1983) Basic analysis of structural safety. *Journal of Structural Engineering*, ASCE, **109**, 721-740.
- [9.13] G.I. Schuëller and R. Stix (1987) A critical appraisal of methods to determine failure probabilities. *Structural Safety*, **4**, 293-309.

Chapter 10

LOAD COMBINATIONS

10.1 Ferry Borges-Castanheta load model

Within the probabilistic reliability analysis the loads are in principle modeled as random variables that are functions of both time and position on the structure. Usually such random functions are denoted as random (or stochastic) processes when they are considered as functions of time and random fields when it is their variation in space (that is, over the structure) that is considered. In this chapter we will treat a load model which is constructed in a particular simple way with respect to the time variation. The model is idealized to such a degree that one hardly can state that it reflects realistic details in the load history. On the other hand, the model captures the essential influence on the failure probability of random changes of the load level. Moreover, the structure of the model makes it well suited for load combination investigations in which additions are made of the effects of several load histories of this type. Another advantage is that the model is easy to describe in a code specification because it can be considered as a direct detailing of the idealized deterministic load configurations that are specified in most current load codes concerning statically acting loads.

The load model will be denoted as the FBC load model after J. Ferry Borges and M. Castanheta, who suggested it for code specification [10.1]. First we define a scalar FBC process as a sequence of rectangular load pulses of fixed duration τ following immediately after each other, Fig. 10.1. The elements in the corresponding sequence of pulse amplitudes are mutually independent identically distributed random variables (that is, the sequence of amplitudes is a so-called Bernoulli sequence). The process starts at time $t = 0$. It is written as $X(t, \tau)$.

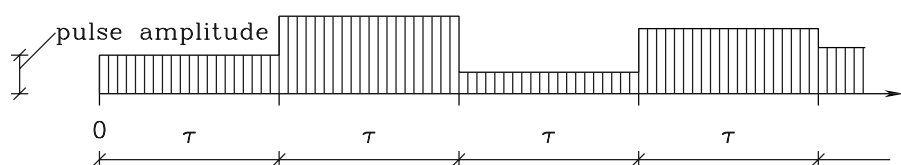

Figure 10.1: Realization (sample curve) of FBC process $X(t, \tau)$.

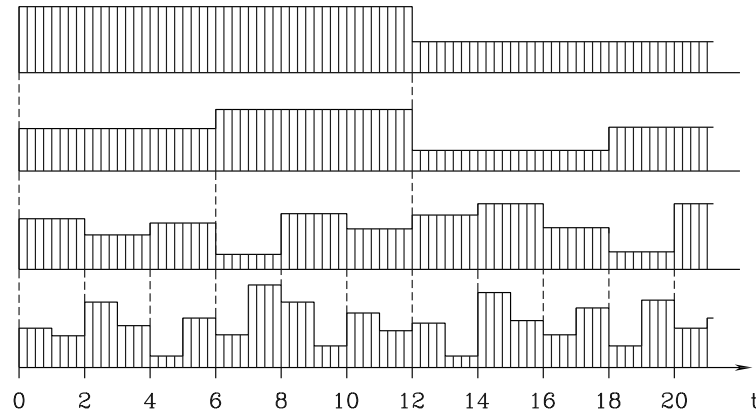

Figure 10.2: Realization of four-combination FBC process $[X_1(t, 12), X_2(t, 6), X_3(t, 2), X_4(t, 1)]$.

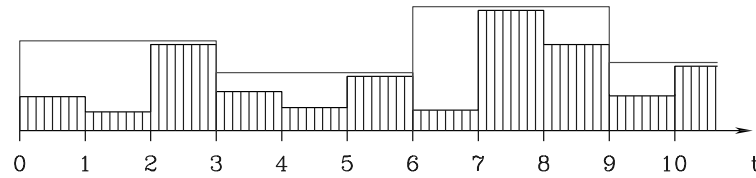

Figure 10.3: Realization of FBC process $X(t, 1)$ with corresponding realization of the T -duration envelope $X(t, 3)$ with $T = 3$.

An n -combination FBC process is a vector $[X_1(t, \tau_1), \dots, X_n(t, \tau_n)]$ of scalar FBC processes ordered with respect to element number such that the pulse durations are never increasing, that is, such that $\tau_1 \geq \tau_2 \geq \dots \geq \tau_n$, and which relative to each other have the particular property that τ_i/τ_j is an integer for all $i \leq j$, Fig. 10.2.

It turns out to be convenient to introduce a special family of envelope processes to an FBC process: the T -duration envelope to an FBC process $X(t, \tau)$ is an FBC process denoted as $X(t, T)$, in which the pulse duration T is an integer multiple of τ and in which the amplitude is defined as the maximum of $X(t, \tau)$ over the considered pulse interval for $X(t, T)$, Fig. 10.3. For $T = \tau$ the envelope and the FBC process are identical.

Assume now that the different FBC load processes contribute linearly to a load effect with positive influence coefficients. Moreover, assume that all load pulse amplitudes are non-negative with probability one. It is then sufficient to study the sum

$$X_1(t, \tau_1) + \dots + X_n(t, \tau_n) \tag{10.1.1}$$

of the elements in an n -combination FBC process. We ask for the probability distribution of the maximal load effect within the time interval $[0, \tau_1]$. By considering Fig. 10.2 it is directly seen that the n th term $X_n(t, \tau_n)$ in the sum (10.1.1) can be replaced by the corresponding τ_{n-1} -envelope $X_n(t, \tau_{n-1})$ without changing the maximal load effect. Since

$$Z_{n-1}(t, \tau_{n-1}) \equiv X_{n-1}(t, \tau_{n-1}) + X_n(t, \tau_{n-1}) \tag{10.1.2}$$

is an FBC process, the n -combination problem is by this reduced to an $(n-1)$ -combination problem corresponding to the $(n-1)$ -combination FBC process $[X_1(t, \tau_1), \dots, X_{n-2}(t, \tau_{n-2}), Z_{n-1}(t, \tau_{n-1})]$.

The distribution function of the amplitudes of $Z_{n-1}(t, \tau_{n-1})$ is the convolution

$$F_{Z_{n-1}(t, \tau_{n-1})} = \int_{-\infty}^{\infty} F_{X_n(t, \tau_{n-1})}(z-x) f_{X_{n-1}(t, \tau_{n-1})}(x) dx \quad (10.1.3)$$

between the density function $f_{X_{n-1}(t, \tau_{n-1})}(x)$ and the distribution function

$$F_{X_n(t, \tau_{n-1})}(x) = [F_{X_n(t, \tau_n)}(x)]^{\tau_{n-1}/\tau_n} \quad (10.1.4)$$

for the τ_{n-1} -envelope of $X_n(t, \tau_n)$.

It follows from this reduction of the dimension of the problem that the distribution function of the maximal load effect is determined by $n-1$ subsequent convolution integrations. Generally such a computation is difficult to do by use of standard analytical or numerical methods.

If we assume that all the amplitude distributions are absolutely continuous (definition in Section 7.2), and that we only want to find fractile values in the upper tail of the distribution of the maximal load effect, it is usually so that we can achieve a sufficient accuracy for practical purposes by applying FORM.

However, the assumption of absolutely continuous amplitude distributions cannot be kept for all FBC processes in a realistic n -combination problem. For several load types of intermittent nature such as load histories where the load pulses are caused by extraordinary events (conglomeration of people at party events, strong winds, etc.) the FBC processes that model these load histories must be such that there are large probabilities for having zero load amplitude in a given pulse duration interval. This means that the corresponding distribution functions for the amplitudes have jumps at zero. In this case there is no unique mapping of the physical formulation space onto a standard Gaussian space. However, the existence of such a mapping is necessary for a direct application of FORM.

It is a consequence of (10.1.4) that if the distribution function of $X_n(t, \tau_n)$ is zero on the negative axis and has the jump p at zero, then the corresponding τ_{n-1} -envelope has an amplitude distribution function with the jump p^{τ_{n-1}/τ_n} at zero. If this jump is suitably small as compared to 1 a direct application of FORM gives no problems. If p^{τ_{n-1}/τ_n} has a disturbingly large size, the problem can be solved by a combined application of FORM and Monte Carlo methods that cause a reduction of the jump [9.4].

Next section illustrates the particular application of the normal tail approximation principle that appears for the FBC n -combination problem under the assumption that all amplitude distributions are absolutely continuous. The iteration algorithm known as the Rackwitz-Fiessler algorithm [7.6] appeared first in this special form.

10.2 Rackwitz-Fiessler algorithm for absolutely continuous distribution functions

Due to the recursive reduction of the n -combination problem it is sufficient first to consider the case $n = 2$. The RF algorithm computes an approximation to the value of both the distribution

function and the density function of

$$Z_1(t, \tau_1) = X_1(t, \tau_1) + X_2(t, \tau_1) \quad (10.2.1)$$

for an arbitrary choice of the argument z in the following way. Choose a point (x_1, x_2) on the straight line

$$x_1 + x_2 = z \quad (10.2.2)$$

and determine (μ_1, σ_1) and (μ_2, σ_2) by use of (7.4.25) and (7.4.26) for $i = 1$ and 2 , where $F_1 = F_{X_1(t, \tau_1)}$ and $F_2 = F_{X_2(t, \tau_1)}$, that is, $\Phi[(x_i - \mu_i)/\sigma_i] = F_i(x_i)$, $\varphi[(x_i - \mu_i)/\sigma_i]/\sigma_i = f_i(x_i)$, $i = 1, 2$. Hereby the density function and the distribution function of $Z_1(t, \tau_1)$ get their values at z approximated by the values at z of the density function and the distribution function, respectively, of the normal distribution with parameters

$$\mu = \mu_1 + \mu_2, \quad \sigma = \sqrt{\sigma_1^2 + \sigma_2^2} \quad (10.2.3)$$

It is obvious that the results depend on the approximation point (x_1, x_2) . For each choice of z we therefore should look for the "best" approximation point. This is made by the "backward" part of the RF algorithm in the following way. A new approximation point (x_1, x_2) is chosen as the point on the straight line (10.2.2), at which the product of the two approximating normal density functions with parameters (μ_1, σ_1) and (μ_2, σ_2) has maximal value. Using the Lagrangian multiplier method this point is obtained by minimalizing $[(x_1 - \mu_1)/\sigma_1]^2 + [(x_2 - \mu_2)/\sigma_2]^2 - 2\lambda(x_1 + x_2 - z)$. Setting the partial derivatives to zero we get $x_1 - \mu_1 = \lambda\sigma_1^2$ and $x_2 - \mu_2 = \lambda\sigma_2^2$, which by addition gives $z - \mu = \lambda\sigma^2$. Thus

$$(x_1, x_2) = (\mu_1 + \beta\alpha_1\sigma_1, \mu_2 + \beta\alpha_2\sigma_2) \quad (10.2.4)$$

in which

$$\beta = \frac{z - \mu}{\sigma}, \quad (\alpha_1, \alpha_2) = \left(\frac{\sigma_1}{\sigma}, \frac{\sigma_2}{\sigma} \right) \quad (10.2.5)$$

The procedure is repeated with start at the new approximation point (x_1, x_2) . By continued iteration in this way a sequence of points $(x_{11}, x_{21}), (x_{12}, x_{22}), \dots, (x_{1n}, x_{2n}), \dots$ is generated. If the sequence converges to a point (x_1, x_2) , this point is a locally most central point on the straight line (10.2.2) and

$$F_{Z_1}(z) \approx \Phi\left(\frac{z - \mu}{\sigma}\right), \quad f_{Z_1}(z) \approx \frac{1}{\sigma}\varphi\left(\frac{z - \mu}{\sigma}\right) \quad (10.2.6)$$

Exercise 10.1 Show that the RF algorithm for $n = 2$ is identical with the algorithm (7.4.9) based on Theorem 7.1. \square

For $n > 2$ the RF algorithm runs as follows. Choose an approximation point (x_1, \dots, x_n) on the hyperplane

$$x_1 + \dots + x_n = z \quad (10.2.7)$$

and define the subsums

$$\begin{aligned}
 z_n &= x_n \\
 z_{n-1} &= x_{n-1} + z_n \\
 z_{n-2} &= x_{n-2} + z_{n-1} \\
 &\vdots \\
 z_2 &= x_2 + z_3 \\
 z_1 &= x_1 + z_2
 \end{aligned} \tag{10.2.8}$$

by which $z_1 = z$. In the first step of the algorithm, approximation values for the distribution function and the density function of $Z_{n-1}(t, \tau_{n-1})$ corresponding to the argument z_{n-1} are obtained as explained for $n = 2$ before entering the backward part of the algorithm. With these approximation values as input the same computation is made for

$$Z_{n-2}(t, \tau_{n-2}) = X_{n-2}(t, \tau_{n-2}) + Z_{n-1}(t, \tau_{n-2}) \tag{10.2.9}$$

where $Z_{n-2}(t, \tau_{n-2})$ is the τ_{n-2} -envelope of the FBC process $Z_{n-1}(t, \tau_{n-1})$. These computations give approximation values for the distribution function and the density function of $Z_{n-2}(t, \tau_{n-2})$ for the argument z_{n-2} . By continuing recursively in this way we end up having determined approximation values of the distribution function and the density function, respectively, for

$$Z_1(t, \tau_1) = X_1(t, \tau_1) + Z_2(t, \tau_1) = \max\{X_1(t, \tau_1) + \dots + X_n(t, \tau_n)\} \tag{10.2.10}$$

corresponding to the argument z .

For the search of a better approximation point the backward part of the algorithm is next used $n - 1$ successive times as for $n = 2$. First x_1 and z_2 are obtained such that $x_1 + z_2 = z$; next x_2 and z_3 are obtained such that $x_2 + z_3 = z_2$, etc, see (10.2.8). With the new approximation point (x_1, \dots, x_n) as starting point the algorithm is run from scratch. The iteration runs until some stop criterion is satisfied.

10.2.1 SORM correction

After the final identification of the best approximation point (x_1, x_2, \dots, x_n) , the first order probability estimate is

$$p_{\text{FORM}} = \Phi\left(\frac{z - \mu_{z_1}}{\sigma_{z_1}}\right) \tag{10.2.11}$$

where $\mu_{z_1} = \mu_{x_1} + \mu_{z_2}$ and $\sigma_{z_1}^2 = \sigma_{x_1}^2 + \sigma_{z_2}^2$ as obtained in the terminating iteration. To get a correction for curvature of the $n - 1$ intermediate limit states $x_{i-1} + z_i = z_{i-1}$, $i = 2, \dots, n$, after mapping to the respective standard Gaussian spaces, all the final mean values $\mu_{z_{i-1}} = \mu_{x_{i-1}} + \mu_{z_i}$ and variances $\sigma_{z_{i-1}}^2 = \sigma_{x_{i-1}}^2 + \sigma_{z_i}^2$ are needed. At the first step in the final iteration of the forward algorithm the obtained final (z_n, x_{n-1}) maps into the most central limit state point (the beta point)

$$\mathbf{u} = (u_1, u_2) = [\Phi^{-1}(F_n(z_n)^{\tau_{n-1}/\tau_n}), \Phi^{-1}(F_{n-1}(x_{n-1}))] \tag{10.2.12}$$

in the standard Gaussian space. To obtain a numerical estimate of the curvature of the corresponding limit state surface in the standard Gaussian space at the beta point a suitable number δ_{n-1} ($\delta_{n-1} = z_{n-1}/10$, say) is added to z_n and subtracted from x_{n-1} and the point

$$\mathbf{v} = (v_1, v_2) = [\Phi^{-1}(F_n(z_n + \delta_{n-1})^{\tau_{n-1}/\tau_n}), \Phi^{-1}(F_{n-1}(x_{n-1} - \delta_{n-1}))] \quad (10.2.13)$$

is calculated. The radius of curvature of the limit state curve at the beta point is thereafter approximated by

$$R = \frac{(\mathbf{u} - \mathbf{v})^\top (\mathbf{u} - \mathbf{v})}{2(\mathbf{u} - \mathbf{v})^\top \mathbf{u} / \|\mathbf{u}\|} \quad (10.2.14)$$

using that the arch length between the points \mathbf{u} and \mathbf{v} can be approximated by $\sqrt{(\mathbf{u} - \mathbf{v})^\top (\mathbf{u} - \mathbf{v})}$ and that the angle between the tangents at the points \mathbf{u} and \mathbf{v} can be approximated as twice the cosine to the angle between the vector \mathbf{u} and the vector $\mathbf{u} - \mathbf{v}$.

According to Breitung's asymptotic curvature-correction formula (6.4.10) the first order intermediate probability

$$p_{n-1} = \Phi\left(\frac{z_{n-1} - \mu_{z_{n-1}}}{\sigma_{z_{n-1}}}\right) \quad (10.2.15)$$

can be approximately corrected by the factor

$$k_{n-1} = \left(1 - \frac{\beta_{n-1}}{R_{n-1}}\right)^{-1/2} \quad (10.2.16)$$

where $\beta_{n-1} = -\Phi^{-1}(p_{n-1})$ and $R_{n-1} = R$. Instead of changing the RF algorithm at this place to take care of the correction, the factor k_{n-1} is stored for application directly on the final FORM result (10.2.11). Thus the originally obtained point (x_1, x_2, \dots, x_n) is left unchanged. In the next and the following steps of the forward algorithm there are similar curvature corrections. The only change is that (10.2.12) and (10.2.13) are changed to

$$\mathbf{u} = (u_1, u_2) = \left\{ \Phi^{-1} \left[\Phi \left(\frac{z_i - \mu_i}{\sigma_i} \right)^{\tau_{i-1}/\tau_i} \right], \Phi^{-1}(F_{i-1}(x_{i-1})) \right\} \quad (10.2.17)$$

and

$$\mathbf{v} = (v_1, v_2) = \left\{ \Phi^{-1} \left[\Phi \left(\frac{z_i + \delta_{i-1} - \mu_i}{\sigma_i} \right)^{\frac{\tau_{i-1}}{\tau_i}} \right], \Phi^{-1}(F_{i-1}(x_{i-1} - \delta_{i-1})) \right\} \quad (10.2.18)$$

and n is replaced by i in (10.2.15) and (10.2.16) where $i = 2, \dots, n-1$. Finally the FORM probability (10.2.11) is corrected to

$$p_{\text{SORM}} = p_{\text{FORM}} \prod_{j=1}^{n-1} k_j \quad (10.2.19)$$

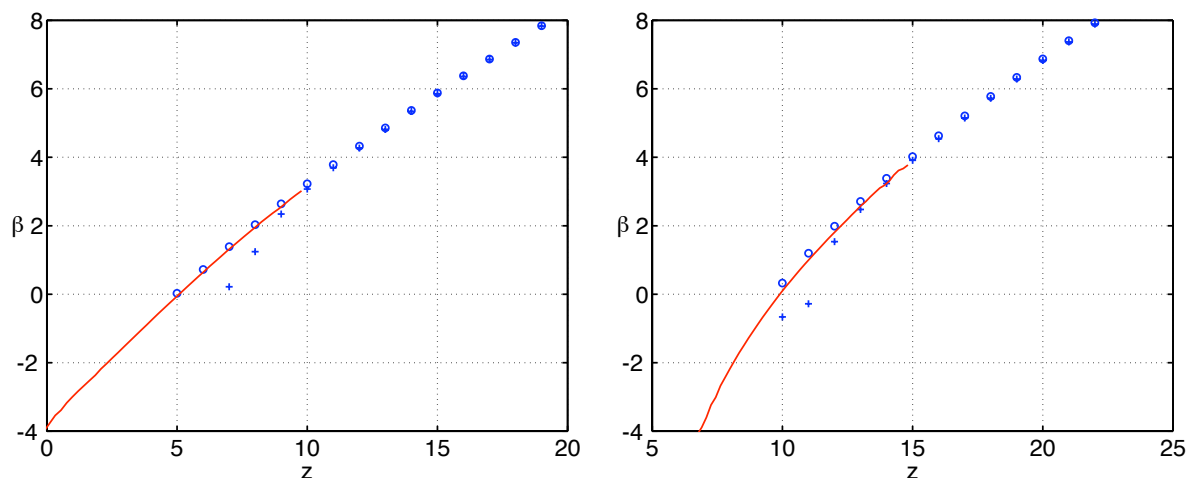

Figure 10.4: Standard Gaussian fractiles (reliability indices) $\beta = \Phi^{-1}[P(\max\{Z_1, \dots, Z_N\} \leq z)]$ determined by simulation (solid curve, sample size 100 000), FORM by RF algorithm \circ , and after curvature correction $+$. The hierarchical system has 5 levels ($n = 4$) with 4 variables at each level. All random variables are either standard Gaussian: $f(x) = \exp(-x^2/2)/\sqrt{2\pi}$ (left), or standard Rayleigh: $f(x) = x \exp(-x^2/2), x \geq 0$, (right). The second order corrections are insignificant.

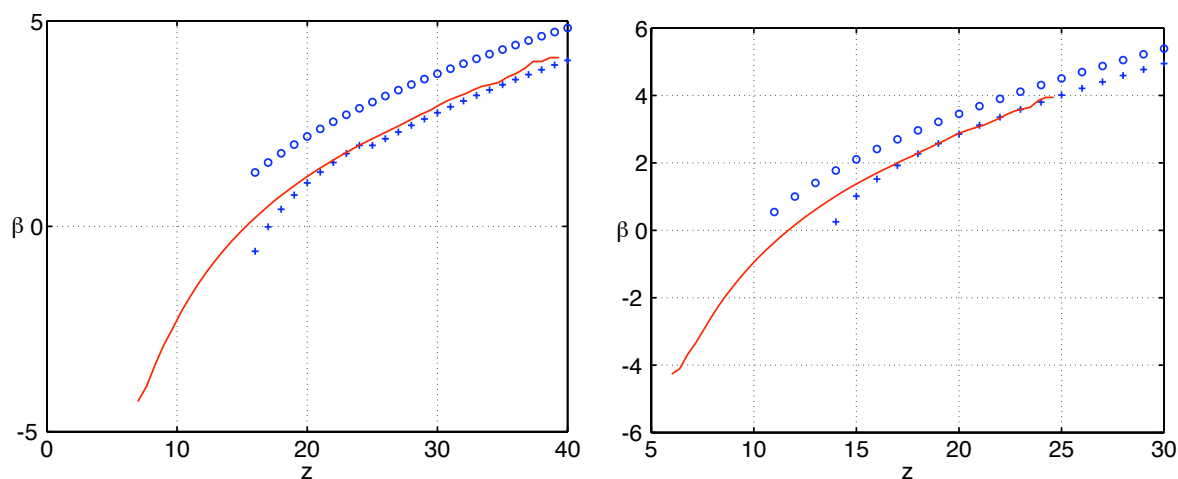

Figure 10.5: Caption as in Fig. 10.4 except that all random variables of the hierarchical system are either one degree of freedom χ^2 -distributed: $f(x) = \sqrt{x/2\pi} \exp(-x/2), x \geq 0$, (left), or standard exponential: $f(x) = e^{-x}, x \geq 0$, (right). The second order corrections are substantial.

10.2.2 Accuracy verification

Figures 10.4 to 10.6 show $\beta = \Phi^{-1}[P(\max\{Z_1, \dots, Z_N\} \leq z)]$ as function of z determined by Monte Carlo simulation (solid curves). The points marked by \circ are the Rackwitz-Fiessler FORM approx-

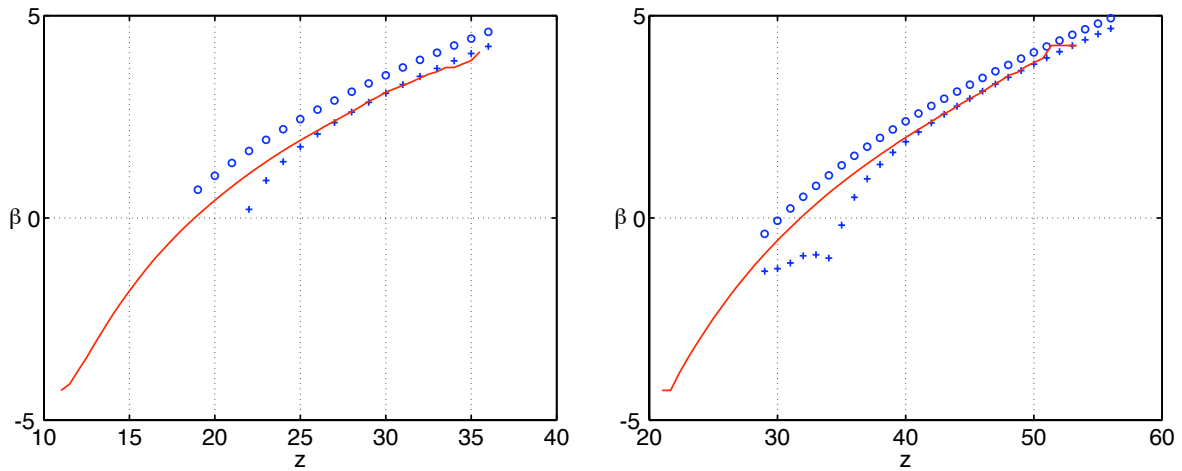

Figure 10.6: Caption as in Fig. 10.4 except that all random variables of the hierarchical system are gamma distributed: $f(x) = x^{k-1} e^{-x} / \Gamma(k), x \geq 0$, here standard Erlang distributions of mean $k = 2$ (left) and $k = 4$ (right). The second order corrections are substantial.

imations while the points marked by + are the curvature corrected values according to (10.2.19). The considered n -combination FBC processes all have $n = 5$ with $\tau_{i-1} / \tau_i = 4$. For each example the X variables are identically distributed. The distributions are standard Gaussian in Fig. 10.4 (left) and standard Rayleigh in Fig. 10.4 (right). It is seen that the FORM results are almost coinciding with the simulated solid curves and that the curvature corrections change the FORM results by almost nothing.

The situation is very different in Figs. 10.5 and 10.6. In Fig. 10.5 (left) the distribution of X is the χ^2 -distribution of one degree of freedom, that is, the distribution of the square of a standard Gaussian variable. It is seen that the FORM results are drastically in error to the side of underestimating the probabilities of exceeding the level z (in fact, an error in β as large as about 1). However, the corrected results obtained from (10.2.19) are surprisingly close to the simulated curve. The same feature is seen in Fig. 10.5 (right) in which the distribution is the standard exponential, and in Fig. 10.6 in which the distributions are Erlang distributions of means $k = 2$ (left) and $k = 4$ (right).

It seems that the curvature generated error is unimportant for distributions with upper density function tails that decrease as for the Gaussian distribution (more precisely as a power function in x times $e^{-x^2/2}$) while the error becomes large and to the nonconservative side for upper density function tails that decrease as the exponential distribution (more precisely as a power function in x times e^{-x}). The distributions used in Figs. 10.5 and 10.6 belong to the gamma distribution family that has exponentially decreasing upper tail.

The deviations in the lower end of values of z are expected because the asymptotic assumptions behind Breitung's formula become dubious for small positive values of the reliability index. Obviously the assumptions are not satisfied for negative values of the reliability index.

10.3 Clipped random variables as load pulse amplitudes

For the application of Monte Carlo methods it turns out to be convenient to let the load pulse amplitudes be clipped random variables generated from random variables with absolutely continuous distribution functions. A random variable Y is said to be generated by clipping of the random variable X at zero, if

$$Y = \max\{0, X\} \quad (10.3.1)$$

In particular, if X is normally distributed with parameters μ, σ , we will say that Y is clipped normally distributed with parameters μ, σ . A similar terminology will be used for other named distribution types.

That it is convenient to let the pulse amplitudes be modeled by random variables of the form (10.3.1) is partly explained by the property that

$$\max\{\max\{0, X_1\}, \dots, \max\{0, X_n\}\} = \max\{0, \max\{X_1, \dots, X_n\}\} \quad (10.3.2)$$

and moreover that the event

$$\sum_{i=1}^n \max\{0, X_i\} \leq z \quad (10.3.3)$$

occurs if and only if all $2^n - 1$ subsums of the sum $X_1 + \dots + X_n$ are less or equal to z . The probability of the event (10.3.3) can therefore in principle be computed by use of methods for series systems defined by linear safety margins with absolutely continuous distribution functions. These properties imply also that both the distribution function and the density function of the sum in (10.3.3) in a simple way may be estimated by directional simulation such as illustrated in Examples 9.1 and 9.3.

Remark 10.1 Any pulse amplitude Y with distribution function

$$F_Y(x) = p\mathbf{1}_{x \geq 0} + (1 - p)F(x) \quad (10.3.4)$$

where $F(x)$ is an absolutely continuous distribution function which is zero on the negative axis can be written as (10.3.1), where X has an absolutely continuous distribution function. All what is needed is to define X such that it gets the distribution function

$$F_X(x) = p \frac{1 - F(b - ax)}{1 - F(b)} \mathbf{1}_{x < 0} + [p + (1 - p)F(x)] \mathbf{1}_{x \geq 0} \quad (10.3.5)$$

where a and b are arbitrary positive constants. If in particular we choose

$$a = \frac{1 - p}{p} \frac{f(0)}{f(b)} [1 - F(b)] \quad (10.3.6)$$

where $f(x)$ is the density function corresponding to $F(x)$, this ensures that the density function for X is continuous at zero.

An example is

$$F(x) = \Phi_\gamma\left(\frac{x-\mu}{\sigma}\right) \quad (10.3.7)$$

where $\gamma = -\mu/\sigma$ and

$$\Phi_\gamma(x) = \frac{\Phi(x) - \Phi(\gamma)}{1 - \Phi(\gamma)} \mathbf{1}_{x \geq \gamma} \quad (10.3.8)$$

is the lower-truncated standard normal distribution function with truncation point γ . The constant a in (10.3.6) becomes

$$a = \frac{1-p}{p} \frac{\varphi(\mu/\sigma)}{\varphi[(\mu-b)/\sigma]} \frac{\Phi[(\mu-b)/\sigma]}{\Phi(\mu/\sigma)} \quad (10.3.9)$$

If we choose $b = 2\mu$ we get

$$a = \frac{1-p}{\Phi(\mu/\sigma)} \frac{\Phi(-\mu/\sigma)}{p} \quad (10.3.10)$$

which gives $a = 1$ if $p = \Phi(-\mu/\sigma)$. The random variable X is then normally distributed with parameters μ, σ and thus $\max\{0, X\}$ is clipped normally distributed.

Another example is the exponential distribution

$$F(x) = (1 - e^{-\lambda x}) \mathbf{1}_{x \geq 0} \quad (10.3.11)$$

with $\lambda > 0$ as parameter. With (10.3.6) substituted, (10.3.5) becomes

$$F_X(x) = p \exp\left(\frac{1-p}{p} \lambda x\right) \mathbf{1}_{x < 0} + [p + (1-p)(1 - e^{-\lambda x})] \mathbf{1}_{x \geq 0} \quad (10.3.12)$$

□

Example 10.1 Let the load effect in a column in a multi-story house be the sum of a permanently acting load effect $\max\{0, X\}$ and the sum of six intermittent floor loads all acting on the floors above the column. Moreover, let there be a snow load contribution which is also of the intermittent type. It is assumed that all the load amplitudes can be modeled as clipped normally distributed random variables [9.4]. Specifically we assume that the maximal load effect within a time period of one year is proportional to

$$L = \max\{0, X\} + \max\{V, S\} \quad (10.3.13)$$

where V corresponds to the winter period and is defined as

$$V = \max_{k=1}^5 T_k \quad (10.3.14)$$

with

$$T_k = \max\{0, X_k\} + U_k \quad (10.3.15)$$

$$U_k = \max_{j=1}^{40} W_{jk} \quad (10.3.16)$$

$$W_{jk} = \sum_{i=1}^6 \max\{0, X_{jk} + X_{ijk}\} \quad (10.3.17)$$

and S corresponds to the summer period and is defined as

$$S = \max_{k=6}^{10} U_k \quad (10.3.18)$$

Thus we have an FBC three-combination problem.

The sums $X_{jk} + X_{ijk}$ ($i = 1, \dots, 6; j = 1, \dots, 40; k = 1, \dots, 10$) represent the intermittent floor loads which are assumed to be renewed 400 times per floor and per year. The variable X_k represents the snow load which is assumed to have five independent renewals per winter (assumed to last half the year).

All X -variables are assumed to be mutually independent and normally distributed. The variables $X_{jk} + X_{1jk}, \dots, X_{jk} + X_{6jk}$ that correspond to the same time interval are seen to be equicorrelated and jointly normally distributed. The correlation coefficient is $\rho = \text{Var}[X_{jk}] / (\text{Var}[X_{jk}] + \text{Var}[X_{ijk}])$.

The following values are considered in dimensionless form (that is, the resulting load effects are obtained after multiplication by a given physical unit for the relevant load effect):

$$\begin{aligned} E[X_{ijk}] &= 0, & D[X_{ijk}] &= \sqrt{1 - \rho} \\ E[X_{jk}] &= -2, & D[X_{jk}] &= \sqrt{\rho}, & \rho &= 0.0, 0.5, 0.8, 1.0 \\ E[X_k] &= -0.15, & D[X_k] &= 0.34 \\ E[X] &= 35, & D[X] &= 1.2 \end{aligned}$$

Table 10.1 shows the corresponding values of $F_L(z)$ and $f_L(z)$ obtained by uniform directional simulation, Fig. 9.1. The table also shows those values that are obtained by the RF-algorithm by use of directional simulation in the first step of the forward part of the algorithm, as explained in below.

The method SIM is pure directional simulation while the method RF is combined use of directional simulation and the RF-algorithm. For the last method the computation time in this example is about 100 times shorter than for SIM. The sample size was 500 in both methods. The columns marked "st.dev." show the standard deviation of the estimator that has given the values in the columns directly to the left of "st.dev.". The abbreviation |dif| is the numerical difference between the results obtained by SIM and RF, respectively. The two value sets corresponding to RF for $\rho = 0.8$ correspond to different initial values (seeds) for the applied random number generator (of the type XOR [9.4]).

The random variables W_{jk} all have the same distribution function $F_W(z)$. According to Remark 6.2 we have that

$$F_W(0) = \int_{-\infty}^{\infty} \Phi\left(\frac{\beta_i + \sqrt{\rho}x}{\sqrt{1-\rho}}\right)^6 \varphi(x) dx \quad (10.3.19)$$

ρ	z	$F_L(z)$	st. dev.	$\frac{ \text{dif} }{\text{st. dev.}}$	$f_L(z)$	st. dev.	$\frac{ \text{dif} }{\text{st. dev.}}$	method		
0.0	38.5	0.936	0.007		0.049	0.009		SIM		
		0.938			0.3			0.097	5.3	RF
0.5	43.5	0.939	0.007		0.018	0.003		SIM		
		0.953			2.0			0.033	4.9	RF
0.8	45.0	0.782	0.012		0.040	0.004		SIM		
		0.782			0.05			0.096	14.4	RF
		0.812			2.5			0.085	11.5	RF
1.0	51.0	0.962	0.006		0.009	0.002		SIM		
		0.956			1.1			0.022	7.1	RF

Table 10.1: Values of the distribution function and the density function for the total load effect L corresponding to the FBC-model in Example 10.1.

which varies between $\Phi(2)^6 \approx 0.871$ for $\rho = 0$ and $\Phi(2) \approx 0.977$ for $\rho = 1$. With these large values of the jump $F_W(0)$, the RF-algorithm is not applicable for computing the values of $F_W(z)$ and $f_W(z)$ for $z > 0$. However, such values can be obtained by uniform directional simulation as explained in Example 9.1.

It is next noted that the random variables U_1, \dots, U_{10} are identically distributed with the distribution function

$$F_U(z) = F_W(z)^{40} \quad (10.3.20)$$

such that

$$F_U(0) = \left[\int_{-\infty}^{\infty} \Phi\left(\frac{\beta_i + \sqrt{\rho}x}{\sqrt{1-\rho}}\right)^6 \varphi(x) dx \right]^{40} \quad (10.3.21)$$

This jump probability varies with ρ as shown in Fig. 10.7.

It is difficult to give general rules that state how big jumps can be tolerated before the applicability of the RF-algorithm becomes doubtful. As for the applicability of FORM and SORM in general the applicability on distributions with jumps at zero is a matter of experience that at present only can be based on comparisons with results from Monte Carlo simulations. In the present example it is seen from Fig. 10.7 that $F_U(0) < 0.1$ for $\rho < \text{about } 0.85$, which is a sufficiently small jump to make it reasonable to try to apply the RF-algorithm for computation of distribution function and density function values of T_k without considering the possibility that $U_k = 0$. However, the possibility that $X_k \leq 0$ should be considered. This event occurs with the large probability $P(X_k \leq 0) = \Phi(0.15/0.34) \approx \Phi(0.44) \approx 0.67$, a jump so large that it cannot be neglected. Thus we write the distribution function value T_k at $z_2 = x_2 + x_3$, see (10.3.2), as

$$F_T(z_2) = F_U(z_2)P(X_k \leq 0) + P(X_k + U_k \leq z_2 | X_k > 0)P(X_k > 0) \quad (10.3.22)$$

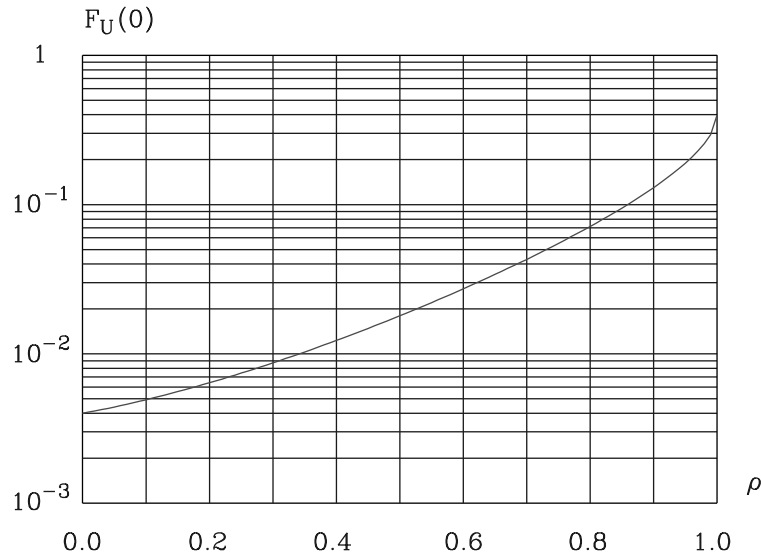

Figure 10.7: Referring to the assumptions of Example 10.1 the diagram shows the probability that 40 successive intervals are without load on all six floors. The abscissa ρ is the equicorrelation coefficient between the loads on the six floors in the sense as defined in the example.

and find the conditional probability

$$P(X_k + U_k \leq z_2 | X_k > 0) \quad (10.3.23)$$

in the first step of the forward part of the RF algorithm. For this we use the conditional distribution function

$$F_{X_k}(x_2 | X_k > 0) = \frac{\Phi[(x_2 + 0.15)/0.34] - \Phi(0.44)}{1 - \Phi(0.44)} \quad (10.3.24)$$

and the corresponding density function together with the distribution function and density function values of U_k at x_3 as obtained by directional simulation.

Since

$$F_{\max\{V,S\}}(z_2) = F_T(z_2)^5 F_U(z_2)^5 \quad (10.3.25)$$

is very small for $z_2 = 0$ and $P(X \leq 0) = \Phi(-35/1.2)$ is also very small, the second and last step of the forward part of the RF-algorithm is running without problems. By this we obtain approximation values for $F_L(z)$ and $f_L(z)$ for $z = z_2 + x_1$. After use of the backward part of the RF-algorithm for obtaining a new starting point (x_1, x_2, x_3) the whole computation is iterated until a suitable stop criterion is satisfied.

It is important for the control of the convergence behavior that the simulated sample of directional vectors is unchanged through the entire iteration sequence. Otherwise the convergence properties of the RF-algorithm may be disturbed by statistical fluctuations caused by the limited sample size.

□

Remark 10.2 The distribution function of the sum

$$Y = \sum_{i=1}^n \max\{0, X_i\} \quad (10.3.26)$$

of n identically distributed and mutually independent clipped normally distributed random variables with parameters μ and $\sigma = 1$ can be well approximated by the distribution function

$$F_n(x; \mu) = F_1(x)H(x) + F_u(x)[1 - H(x)] \quad (10.3.27)$$

where $F_1(x) < F_u(x)$ are distribution functions defined by

$$F_1(x) = \Phi(-\mu)^n + \sum_{q=1}^n \binom{n}{q} \left[\Phi\left(\frac{x}{q} - \mu\right) - \Phi(-\mu) \right]^q \Phi(-\mu)^{n-q} \quad (10.3.28)$$

$$F_u(x) = \Phi\left(\frac{x - n\mu}{\sqrt{n}}\right) \quad (10.3.29)$$

and where $H(x)$ is a distribution function defined by

$$H(x) = \exp\{-ax^b \exp[-c(\log x)^2]\} \quad (10.3.30)$$

The parameters a, b and c which define $H(x)$ have for each value of n and m been determined by curve fitting of $F_n(x; \mu)$ to the distribution function of Y obtained by directional simulation.

The parameter values can be read for $n = 3, 4, \dots, 20$ and different values of μ from the diagrams put together in Fig. 10.8. These diagrams are taken from [9.4] in which information about the accuracy of the approximation is given. Also an approximation for the density function of Y is given which is more accurate than the approximation obtained by differentiation of $F(x)$.

When $\sigma \neq 1$, the variables x and μ must be replaced by x/μ and μ/σ , respectively, in (10.3.27) - (10.3.30). □

Example 10.2 In Example 2.6 we obtained load reduction factors ψ_n under the assumption that all load pulse amplitudes X_{ij} are mutually independent and normally distributed. Omitting the distribution assumptions we have that the remaining assumptions of Example 2.6 imply that

$$\bar{F}_n[x_c + (n-1)\psi_n x_c / \gamma] = \bar{F}_1(x_c) \quad (10.3.31)$$

which is obtained by substitution of (2.7.11) into (2.7.8). Moreover we have that (2.7.12) is valid asymptotically as $n \rightarrow \infty$ and thus, according to (2.7.13),

$$\psi_\infty = \frac{E[X_{ij}]}{x_c} \gamma \quad (10.3.32)$$

Finally it follows from (2.7.5) that the characteristic load value x_c corresponding to $\max\{X_{i1}, \dots, X_{iN}\}$ can be approximated by

$$x_c \approx \bar{F}_1^{-1}\left(\frac{\epsilon}{N}\right) \quad (10.3.33)$$

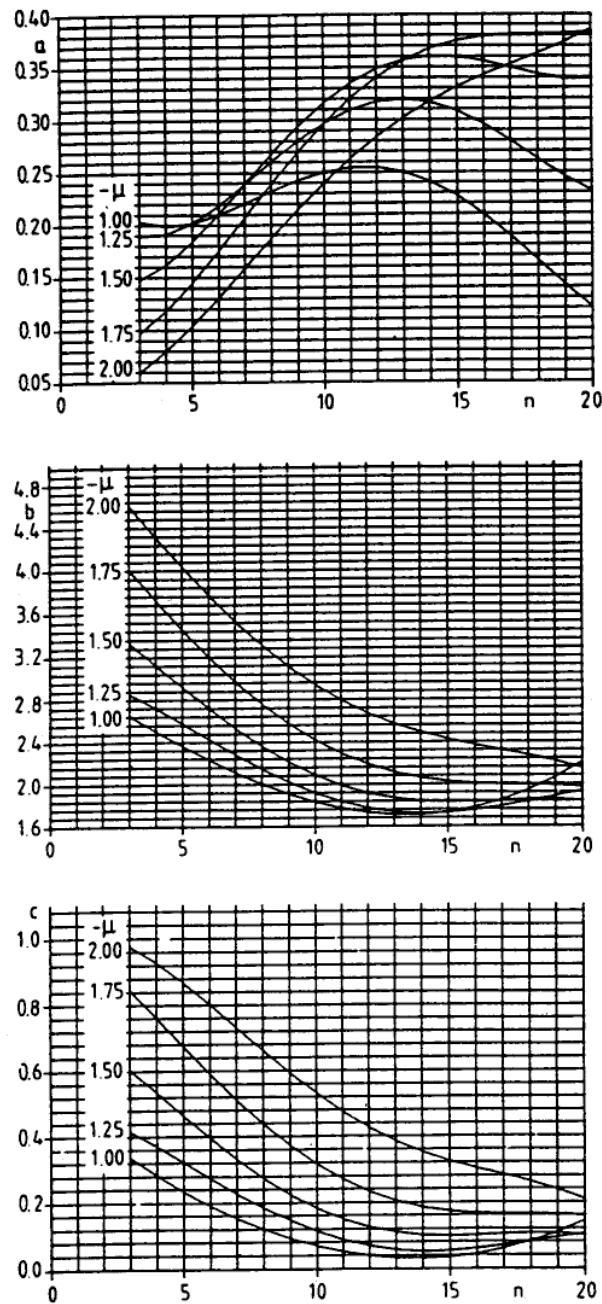

Figure 10.8: The parameters a , b , and c that define the distribution function $H(x)$ in (10.3.30).

for $\epsilon \ll 1$.

Assume that X_{ij} is clipped normally distributed with parameters (μ, σ) . Then

$$\bar{F}_1(x) = \Phi\left(-\frac{x-\mu}{\sigma}\right), \quad x \in \mathbb{R}_+ \tag{10.3.34}$$

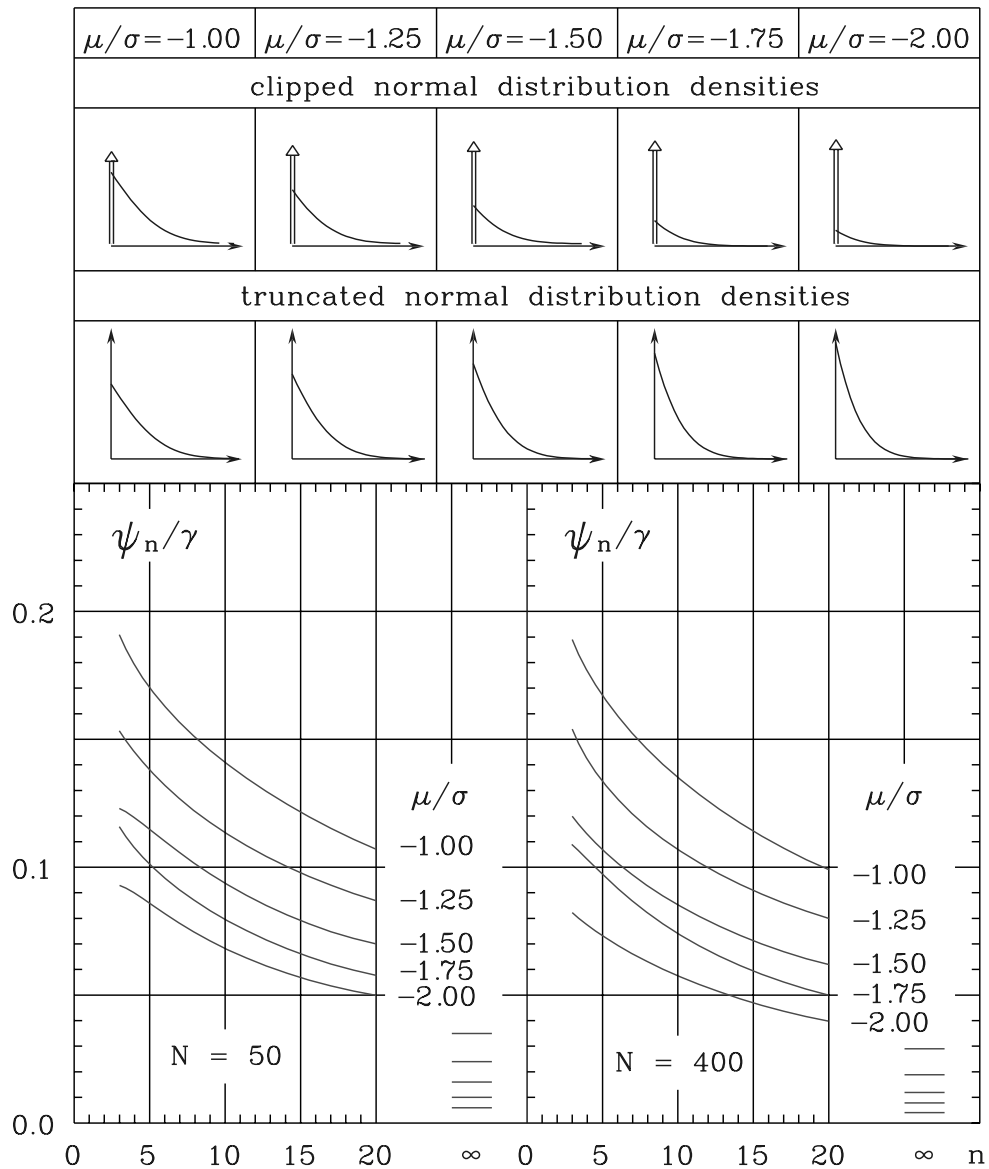

Figure 10.9: The ratio between the load reduction factor ψ_n and the partial coefficient γ for the column load as function of the number of floors n above the column. The characteristic load value is defined as the 98%-fractile in the distribution of the maximal load on a single floor as a result of N independent load replacements. The load pulse amplitude of each single replacement is of clipped normal distribution type as illustrated in the top of the figure. The load reduction factor is defined according to the principles of the Danish code DS 409 [2.2].

so that (10.3.33) gives

$$x_c = \mu - \sigma \Phi^{-1} \left(\frac{\epsilon}{N} \right) \tag{10.3.35}$$

where ϵ/N is assumed to be small enough to make $x_c > 0$. Moreover we find by elementary

calculations that

$$E[X_{ij}] = \sigma\theta \quad (10.3.36)$$

$$\theta = \varphi\left(\frac{\mu}{\sigma}\right) + \frac{\mu}{\sigma}\Phi\left(\frac{\mu}{\sigma}\right) \quad (10.3.37)$$

which by substitution into (10.3.32) gives

$$\frac{\psi_\infty}{\gamma} = \frac{\varphi\left(\frac{\mu}{\sigma}\right) + \frac{\mu}{\sigma}\Phi\left(\frac{\mu}{\sigma}\right)}{\frac{\mu}{\sigma} - \Phi^{-1}\left(\frac{\epsilon}{N}\right)} \quad (10.3.38)$$

By use of (10.3.27) and (10.3.34) in (10.3.31) we get the equation

$$\bar{F}_n \left\{ \frac{\gamma\theta}{\psi_\infty} \left[1 + (n-1)\frac{\psi_n}{\gamma} \right]; \frac{\mu}{\sigma} \right\} = \Phi\left(\frac{\mu}{\sigma} - \frac{\gamma\theta}{\psi_\infty}\right) \quad (10.3.39)$$

for the determination of ψ_∞/γ as function of n for given values μ/σ and ϵ/N , Fig. 10.9.

As expected, it is seen that the influence from N is modest. Moreover it is seen that the convergence of ψ_n to ψ_∞ as $n \rightarrow \infty$ is very slow and that it can be strongly to the unsafe side to apply ψ_∞ in stead of ψ_n as load reduction factor in practical reliability evaluations. How much it will be to the unsafe side to use ψ_∞ in stead of ψ_n naturally depends on the contributions to the total load from the other load types that act on the structure. \square

Bibliography

[10.1] J. Ferry Borges and M. Castanheta (1971) *Structural Safety*. Laboratorio Nacional de Engenharia Civil, course 101, 2nd edition, Lisbon.

This page is intentionally left blank.

Chapter 11

STATISTICAL UNCERTAINTY AND MODEL UNCERTAINTY

11.1 Introduction

Experimental investigations are in many respects essential in connection with layout and design of structures. On the one hand it is a basic scientific principle that mathematical models of the deformability and strength properties (or other relevant physical properties) of structural elements including the materials become subject to experimental investigations with the purpose of verifying and supporting the empirical information value of the models. On the other hand, experimental methods are often used directly as the basis for design rules for different types of structural connections (reinforcement overlapping joints and anchoring lengths in reinforced concrete, nail connections in wooden structures etc). Such design rules have often been formulated by use of dimension analysis combined with use of simple mechanical models. These are assumed to point out the most important dimensionless quantities for the desired property and the relation between these. The experimental method is thereafter used to determine suitable correction factors or terms that make the considered formula fit the experimental results. Occasionally the entire relation between the chosen dimensionless quantities must be determined experimentally.

Due to the most often quite limited number of replicate experiments that economy and time allow for verification or correction of a given model, the statistical uncertainty gets importance when the model becomes a part of a reliability analysis. This statistical uncertainty is an essential contribution to the model uncertainty. Reported quantitative information about the statistical uncertainty attached to experimental model determinations makes it easier to exercise professional evaluation of model uncertainty. This topic is therefore of considerable relevance for the reliability analysis. Even though the problem is a central topic in the general statistical theory (regression analysis) and therefore is treated in most statistical textbooks, it is useful here to treat the most fundamental concepts from the point of view of application that is peculiar for the reliability analysis. In this chapter we therefore return to concepts that were mentioned in Chapter 3.

11.2 Likelihood function. Sufficient statistics

Here we will make the presentation slightly more general by replacing the parameter μ in (3.2.7) and the following formulas by a vector $\boldsymbol{\mu}$ of parameters. We will write the likelihood function (3.2.10) as

$$L(\boldsymbol{\mu}; x_1, \dots, x_n) = \prod_{i=1}^n f_X(x_i | \boldsymbol{\mu}) \quad (11.2.1)$$

It is seen that it has the property

$$L(\boldsymbol{\mu}; x_1, \dots, x_r, x_{r+1}, \dots, x_{r+s}) = L(\boldsymbol{\mu}; x_1, \dots, x_r) L(\boldsymbol{\mu}; x_{r+1}, \dots, x_{r+s}) \quad (11.2.2)$$

such that the posterior density (3.2.9) can be written as

$$f_{\mathbf{M}}(\boldsymbol{\mu} | x_1, \dots, x_r, x_{r+1}, \dots, x_{r+s}) \propto L(\boldsymbol{\mu}; x_{r+1}, \dots, x_{r+s}) f_{\mathbf{M}}(\boldsymbol{\mu} | x_1, \dots, x_r) \quad (11.2.3)$$

where

$$f_{\mathbf{M}}(\boldsymbol{\mu} | x_1, \dots, x_r) \propto L(\boldsymbol{\mu}; x_1, \dots, x_r) f_{\mathbf{M}}(\boldsymbol{\mu}) \quad (11.2.4)$$

The formula (11.2.3) has exactly the same structure as (11.2.4). The probabilistic information given by the posterior density $f_{\mathbf{M}}(\boldsymbol{\mu} | x_1, \dots, x_r)$ is therefore updated by use of the information given by the extra sample x_{r+1}, \dots, x_{r+s} by taking $f_{\mathbf{M}}(\boldsymbol{\mu} | x_1, \dots, x_r)$ as prior density for \mathbf{M} . Together with a given (not sample based) prior density $f_{\mathbf{M}}(\boldsymbol{\mu})$ in 11.2.4 the set of all possible posterior densities form a multi-parameter family of densities in which the sample variables x_1, \dots, x_n (with n arbitrary) are the parameters. This family is closed with respect to multiplication with the likelihood function given by an arbitrary sample. If it is possible to express some prior information about the parameter vector $\boldsymbol{\mu}$ by choosing a density from this family as prior density, the posterior density that summarizes the total information from this prior and the sample x_1, \dots, x_n is obtained as a $(n+k)$ -parameter density from the family. Such a choice of a prior density is obviously equivalent with expressing the prior information in the form of a fictive sample of X of size k .

This property gets a particular convenient form in cases where the likelihood function (remembering that it is interpreted as a function of $\boldsymbol{\mu}$) for any sample size n except for a proportionality factor is uniquely defined by a fixed number q of functions $t_1(x_1, \dots, x_n), \dots, t_q(x_1, \dots, x_n)$ of the sample variables x_1, \dots, x_n (except for a proportionality factor). All samples that give the same q values of those functions thus contain exactly the same information about $\boldsymbol{\mu}$. These q functions are said to be *jointly sufficient statistics* for $\boldsymbol{\mu}$. Thus prior information can in such cases be expressed solely by the values of q jointly sufficient statistics. However, sufficient statistics do not exist for all types of distributions. In fact, it can be shown that joint sufficient statistics exist if and only if the distribution belongs to the so-called *exponential family*, that is, the density function of X must be of the form

$$f_X(x | \boldsymbol{\mu}) \propto g(x) h(\boldsymbol{\mu}) \exp \left[\sum_{j=1}^q u_j(x) \psi_j(\boldsymbol{\mu}) \right] \quad (11.2.5)$$

where g, u_1, \dots, u_q are functions solely of x , while h, ψ_1, \dots, ψ_q are functions solely of $\boldsymbol{\mu}$. It follows directly from (11.2.1) and (11.2.5) that the functions

$$t_j(x_1, \dots, x_n) = \sum_{i=1}^n u_j(x_i) \quad (11.2.6)$$

make up a vector of joint sufficient sample functions for $\boldsymbol{\mu}$. It is more difficult to show that densities of the form (11.2.5) are the only ones for which there is a fixed number q (that is, independent of n) of jointly sufficient sample functions for the parameter vector $\boldsymbol{\mu}$.

It should be noted that the expression (11.2.5) also is interpretable as the frequency function for a discrete random variable X in the sense that $f_X(x|\boldsymbol{\mu}) = P(X = x|\boldsymbol{\mu})$.

In summary, if the considered distribution family with parameter vector $\boldsymbol{\mu}$ has q jointly sufficient sample functions for $\boldsymbol{\mu}$, then the family of all possible posterior densities corresponding to the prior density $f_{\mathbf{M}}(\boldsymbol{\mu})$ is reduced to a q -parameter family of densities. These densities are called *natural conjugate prior densities* corresponding to the density type $f_X(x|\boldsymbol{\mu})$ and the prior density $f_{\mathbf{M}}(\boldsymbol{\mu})$.

11.3 Natural conjugate densities of the normal distribution

Posterior distribution

The normal density

$$f_X(x|\mu, \sigma) = \frac{1}{\sigma} \varphi\left(\frac{x-\mu}{\sigma}\right) \propto \frac{1}{\sigma} \exp\left[-\frac{1}{2}\left(\frac{x-\mu}{\sigma}\right)^2\right] \quad (11.3.1)$$

with parameters $(\mu, \sigma) \in \mathbb{R} \times \mathbb{R}_+$ obviously belongs to the exponential family. By direct calculation of the likelihood function we get

$$L(\mu, \sigma; x_1, \dots, x_n) \propto \left(\frac{1}{\sigma}\right)^n \exp\left[-\frac{n}{2}\left(\frac{s}{\sigma}\right)^2\right] \varphi\left(\frac{\mu - \bar{x}}{\sigma/\sqrt{n}}\right) \quad (11.3.2)$$

where

$$\bar{x} = \frac{1}{n} \sum_{i=1}^n x_i \quad (11.3.3)$$

$$s^2 = \frac{1}{n} \sum_{i=1}^n (x_i - \bar{x})^2 = \bar{x^2} - \bar{x}^2 \quad (11.3.4)$$

and n together are sufficient statistics for (μ, σ) .

Let $(M, \log \Sigma)$ as in Chapter 3 be that pair of Bayesian random variables that represents the uncertain knowledge of $(\mu, \log \sigma)$. Missing prior information about the parameters can be modeled formally, e.g. by choosing the prior density of $(M, \log \Sigma)$ equal to a positive constant over a domain

Ω of the $(\mu, \log \sigma)$ -plane with finite area and equal to zero outside this domain. Since $d(\log \sigma)/d\sigma = 1/\sigma$, this choice implies that

$$f_{M,\Sigma}(\mu, \sigma) \propto \frac{1}{\sigma} \quad (11.3.5)$$

for $(\mu, \log \sigma) \in \Omega$. By letting Ω expand to the entire \mathbb{R}^2 , (11.2.4), (11.3.2) and (11.3.5) give the posterior density

$$f_{M,\Sigma}(\mu, \sigma | x_1, \dots, x_n) \propto \left(\frac{1}{\sigma}\right)^{n+1} \exp\left[-\frac{n}{2}\left(\frac{s}{\sigma}\right)^2\right] \varphi\left(\frac{\mu - \bar{x}}{\sigma/\sqrt{n}}\right) \quad (11.3.6)$$

for $(\mu, \sigma) \in \mathbb{R} \times \mathbb{R}_+$. This expansion of Ω to \mathbb{R}^2 is said to define a *diffuse density* of $(M, \log \Sigma)$ over \mathbb{R}^2 . The posterior density (11.3.6) shows that the natural conjugate prior densities are of the form

$$f_{M,\Sigma}(\mu, \sigma) \propto \left(\frac{1}{\sigma}\right)^{\nu+1} \exp\left[-\frac{\nu}{2}\left(\frac{\beta}{\sigma}\right)^2\right] \varphi\left(\frac{\mu - \alpha}{\sigma/\sqrt{\nu}}\right) \quad (\mu, \sigma) \in \mathbb{R} \times \mathbb{R}_+ \quad (11.3.7)$$

with parameters $(\alpha, \beta, \nu) \in \mathbb{R} \times \mathbb{R}_+^2$. By use of (11.3.7) as prior density the posterior density becomes (11.3.6) in which the jointly sufficient statistics n , \bar{x} and s^2 are replaced by

$$n + \nu \quad (11.3.8)$$

$$\frac{n\bar{x} + \nu\alpha}{n + \nu} \quad (11.3.9)$$

$$\frac{n(s^2 + \bar{x}^2) + \nu(\beta^2 + \alpha^2)}{n + \nu} - \left(\frac{n\bar{x} + \nu\alpha}{n + \nu}\right)^2 = \frac{ns^2 + \nu\beta^2}{n + \nu} + n\nu\left(\frac{\bar{x} - \alpha}{n + \nu}\right)^2 \quad (11.3.10)$$

respectively. It is noted that ν needs not be an integer. In a sequential updating using further obtained sample values the prior density (11.3.7) is then used directly with ν , α and β^2 replaced by (11.3.8), (11.3.9) and (11.3.10), respectively.

It is seen from (11.3.7) that the random variables

$$U = \frac{M - \alpha}{\Sigma/\sqrt{\nu}} \quad (11.3.11)$$

and Σ are mutually independent and that U is standard normal, while Σ has the density

$$f_{\Sigma}(\sigma) \propto \left(\frac{1}{\sigma}\right)^{\nu} \exp\left[-\frac{\nu}{2}\left(\frac{\beta}{\sigma}\right)^2\right], \quad \sigma \in \mathbb{R}_+ \quad (11.3.12)$$

This follows from the product form of (11.3.7) noting that the Jacobi determinant is $\sqrt{\nu}/\sigma$.

Exercise 11.1 Show by simple transformation of density that $\nu\beta^2/\Sigma^2$ has the density

$$f_{\nu\beta^2/\Sigma^2}(t; \nu) \propto t^{(\nu-1)/2-1} e^{-t/2}, \quad t \in \mathbb{R}_+ \quad (11.3.13)$$

This is a so-called *gamma density* with parameters $(\nu-1)/2$ and $1/2$. In particular, if ν is an integer, the density is called a χ^2 -density with $\nu-1$ degrees of freedom.

Compute the normalizing constant to be used in (11.3.13) expressed by the gamma function (11.3.18). Thereby prove the formula (11.3.17). \square

A convenient way to model prior information about μ and σ is to adopt (11.3.12) as the prior density of Σ and assume that M for $\Sigma = \sigma$ given has a normal density. In fact, the natural conjugate prior (11.3.7) is of this form with $E[M|\Sigma = \sigma] = \alpha$ and $D[M|\Sigma = \sigma] = \sigma/\sqrt{\nu}$. However, a larger flexibility than offered by (11.3.12) for the modeling of the prior information is obtained by replacing the parameter ν in (11.3.12) by $\nu + \xi > 0$, where ξ is a parameter that may be chosen independently of the value of ν except that $\xi > -\nu$. Thus (11.3.7) is replaced by the following prior joint density of (M, Σ) :

$$f_{M,\Sigma}(\mu, \sigma) \propto \left(\frac{1}{\sigma}\right)^{\nu+\xi+1} \exp\left[-\frac{\nu+\xi}{2}\left(\frac{\beta}{\sigma}\right)^2\right] \varphi\left(\frac{\mu-\alpha}{\sigma/\sqrt{\nu}}\right), \quad (\mu, \sigma) \in \mathbb{R} \times \mathbb{R}_+ \tag{11.3.14}$$

with parameters $\alpha, \beta > 0, \nu > 0, \xi > -\nu$. It is seen that

$$f_{M,\Sigma}(\mu, \sigma) \propto \begin{cases} \frac{1}{\sigma} & \text{as } \nu \rightarrow 0, \xi \rightarrow 0 \\ \frac{1}{\sigma} \varphi\left(\frac{\mu-\alpha}{\sigma/\sqrt{\nu}}\right) & \text{as } \nu + \xi \rightarrow 0, \nu \text{ fixed} \\ \left(\frac{1}{\sigma}\right)^{\xi+1} \exp\left[-\frac{\xi}{2}\left(\frac{\beta}{\sigma}\right)^2\right] & \text{as } \nu \rightarrow 0, \xi \text{ fixed} \\ \delta(\sigma - \beta) \frac{1}{\sigma} \varphi\left(\frac{\mu-\alpha}{\sigma/\sqrt{\nu}}\right) & \text{as } \xi \rightarrow \infty, \nu \text{ fixed} \\ \delta(\mu - \alpha) \left(\frac{1}{\sigma}\right)^{\nu+\xi} \exp\left[-\frac{\nu+\xi}{2}\left(\frac{\beta}{\sigma}\right)^2\right] & \text{as } \nu \rightarrow \infty, \nu + \xi \text{ fixed} \\ \delta(\mu - \alpha) \delta(\sigma - \beta) & \text{as } \nu \rightarrow \infty, \nu + \xi \rightarrow \infty \end{cases} \tag{11.3.15}$$

where $\delta(\cdot)$ is Dirac's delta function. Thus the prior density (11.3.14), in contrast to (11.3.7), includes all the limiting cases of (a) completely unknown μ, σ , (b) partly known μ , completely unknown σ , (c) completely unknown μ , partly known σ , (d) partly known μ , known σ , (e) known μ , partly known σ , and (f) known μ, σ .

The posterior density corresponding to (11.3.14) is obtained from (11.3.14) by replacing ν and α by (11.3.8) and (11.3.9), respectively, while β^2 is replaced by

$$\frac{ns^2 + (\nu + \xi)\beta^2}{n + \nu + \xi} + n\nu \frac{(\bar{x} - \alpha)^2}{(n + \nu)(n + \nu + \xi)} \tag{11.3.16}$$

which for $\xi = 0$ reduces to (11.3.10). It is seen from (11.3.14) that the statements about U as defined by (11.3.11) and Σ are still valid except that ν in (11.3.12) and (11.3.13) is replaced by $\nu + \xi$.

By use of the standard formula

$$(a > 0, b > 0) \quad \int_0^\infty x^{-(2a+1)} e^{-b/x^2} dx = \frac{1}{2} \Gamma(a) b^{-a} \tag{11.3.17}$$

where $\Gamma(\cdot)$ is the gamma function

$$\Gamma(x) = \int_0^\infty u^{x-1} e^{-u} du \tag{11.3.18}$$

integration of (11.3.14) with respect to σ from 0 to ∞ gives that the marginal density of M :

$$f_M(\mu) \propto \left[1 + \frac{1}{\nu + \xi} \left(\frac{\mu - \alpha}{\beta/\sqrt{\nu}} \right)^2 \right]^{-(\nu + \xi)/2}, \quad \mu \in \mathbb{R} \quad (11.3.19)$$

This shows that the random variable

$$T = \frac{M - \alpha}{\beta/\sqrt{\nu}} \sqrt{\frac{\nu + \xi - 1}{\nu + \xi}} \quad (11.3.20)$$

has the density

$$f_T(t) \propto \left[1 + \frac{t^2}{\nu + \xi - 1} \right]^{-[(\nu + \xi - 1) + 1]/2}, \quad t \in \mathbb{R} \quad (11.3.21)$$

which if $\nu + \xi$ is an integer is a so-called *t-density (Student's density)* with $\nu + \xi - 1$ degrees of freedom. For $\nu + \xi = 2$ it is *Cauchy's density*. The random variable T becomes standard normal as $\xi \rightarrow \infty$ as also seen from (11.3.11) and known from (3.2.13).

Predictive distribution

Given that (M, Σ) has the density (11.3.14), the unconditional density of X can be obtained. The conditional density of X given $(M, \Sigma) = (\mu, \sigma)$ is defined by (11.3.1) and therefore, according to the addition theorem for probabilities, we get that

$$\begin{aligned} f_X(x; \alpha, \beta, \nu, \xi) &= \int_0^\infty \int_{-\infty}^\infty f_X(x | \mu, \sigma) f_{M, \Sigma}(\mu, \sigma) d\mu d\sigma \\ &\propto \int_0^\infty \left(\frac{1}{\sigma} \right)^{\nu + \xi + 1} \exp \left[-\frac{\nu + \xi}{2} \left(\frac{\beta}{\sigma} \right)^2 \right] d\sigma \int_{-\infty}^\infty \varphi \left(\frac{x - \mu}{\sigma} \right) \varphi \left(\frac{\mu - \alpha}{\sigma/\sqrt{\nu}} \right) d\mu \\ &\propto \int_0^\infty \left(\frac{1}{\sigma} \right)^{\nu + \xi + 1} \exp \left[-\frac{\nu + \xi}{2} \left(\frac{\beta}{\sigma} \right)^2 \left\{ 1 + \frac{[(x - \alpha)/\beta]^2}{(\nu + \xi)(\nu + 1)/\nu} \right\} \right] d\sigma \end{aligned} \quad (11.3.22)$$

where we have used (3.2.16). This unconditional density is called the predictive density of X . By comparison of the last integral with (11.3.17) it is seen that

$$2a + 1 = \nu + \xi + 1 \quad (11.3.23)$$

$$b = \frac{(\nu + \xi)\beta^2}{2} \left[1 + \frac{\nu}{(\nu + 1)(\nu + \xi)} \left(\frac{x - \alpha}{\beta} \right)^2 \right] \quad (11.3.24)$$

from which it follows that the predictive density of X is

$$f_X(x; \alpha, \beta, \nu, \xi) \propto \left[1 + \frac{1}{\nu + \xi} \left(\frac{x - \alpha}{\beta\sqrt{1 + 1/\nu}} \right)^2 \right]^{-[(\nu + \xi - 1) + 1]/2}, \quad x \in \mathbb{R} \quad (11.3.25)$$

and thus that the random variable

$$\frac{X - \alpha}{\beta\sqrt{1+1/v}} \sqrt{\frac{v+\xi-1}{v+\xi}} \quad (11.3.26)$$

has a predictive density which is the t -density (11.3.21) with $v+\xi-1$ degrees of freedom given that $v+\xi$ is an integer and that the prior density (11.3.15) is used. If sample information is available, the parameters v , α and β^2 are replaced by (11.3.8), (11.3.9) and (11.3.16), respectively. Missing prior information on μ is represented by putting $v=0$ in (11.3.8), (11.3.9) and (11.3.16) and on σ by putting $\xi=0$. Complete information on σ corresponds to $\xi \rightarrow \infty$, that is, to (3.2.16).

Example 11.1 A structure is loaded with a sequence of random loads X_1, \dots, X_m, \dots , such that X_i is removed before X_{i+1} is applied. The structure survives the m first loads if and only if

$$\max\{X_1, \dots, X_m\} \leq L \quad (11.3.27)$$

where L is a given load level. It is assumed that the loads are mutually independent and normally distributed with common but unknown mean value μ and standard deviation σ . Indirect information is given about μ and σ through a previously obtained sample x_1, \dots, x_n of n loads.

The probability of the survival event (11.3.27) is then for a given prior density equal to

$$\int_{-\infty}^{\infty} d\mu \int_0^{\infty} \Phi\left(\frac{L-\mu}{\sigma}\right)^m f_{M,\Sigma}(\mu, \sigma | x_1, \dots, x_n) d\sigma \quad (11.3.28)$$

where $f_{M,\Sigma}(\mu, \sigma | x_1, \dots, x_n)$ is the posterior density corresponding to the given prior density. Let us keep to the natural conjugate prior densities (11.3.7) and substitute such a density for $f_{M,\Sigma}(\mu, \sigma | x_1, \dots, x_n)$ in (11.3.28). When $m > 1$ the integral cannot be calculated analytically in terms of known functions. However, we may interpret the event (11.3.27) as the intersection

$$\{X_1 \leq L\} \cap \dots \cap \{X_m \leq L\} \quad (11.3.29)$$

described by the m safety margins

$$M_i = L - X_i, \quad i = 1, \dots, m \quad (11.3.30)$$

and use the inequalities (6.3.12) for evaluation of the failure probability. According to (11.3.26) (with $\xi=0$) the marginal failure events

$$\mathcal{F}_i = \{X_i > L\}, \quad i = 1, \dots, m \quad (11.3.31)$$

all have the same probability

$$p_1 = P(\mathcal{F}_i) = F_S\left(-\lambda \sqrt{\frac{v-1}{v+1}}; v-1\right), \quad \lambda = \frac{L-\alpha}{\beta} \quad (11.3.32)$$

where $F_S(\cdot; v-1)$ is the t -distribution function with $v-1$ degrees of freedom.

For the intersection events $\mathcal{F}_i \cap \mathcal{F}_j$ the calculation is more complicated. For $(M, \Sigma) = (\mu, \sigma)$ given, $\mathcal{F}_i \cap \mathcal{F}_j$ can be mapped as in Fig. 11.1.

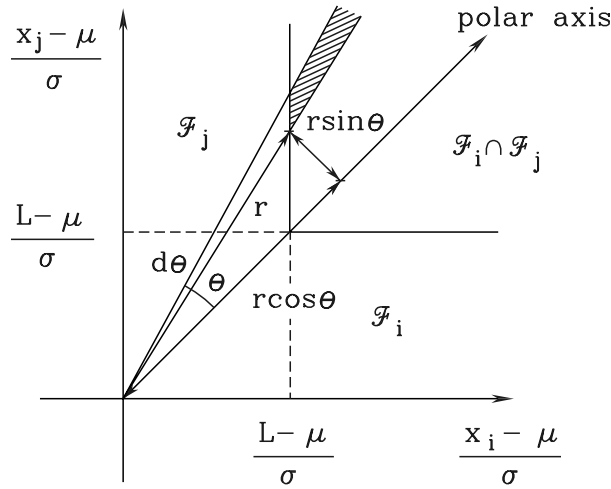

Figure 11.1: Orthogonal and polar representation of the intersection event $\mathcal{F}_i \cap \mathcal{F}_j$ considered in Example 11.1.

By the polar representation shown in Fig. 11.1 we get that

$$P(R > r | M = \mu, \Sigma = \sigma, \Theta = \theta) = \begin{cases} e^{-r^2/2} & \text{for } \mu \leq L \\ 1 \geq e^{-r^2/2} & \text{for } \mu > L \end{cases} \quad (11.3.33)$$

for $0 \leq \theta < \pi/4$ (see Exercise 11.2) where

$$R^2 = \left(\frac{X_i - \mu}{\sigma} \right)^2 + \left(\frac{X_j - \mu}{\sigma} \right)^2 \quad (11.3.34)$$

and

$$r = \psi(\theta) \frac{L - \mu}{\sigma} \quad (11.3.35)$$

$$\psi(\theta) = \frac{\sqrt{2}}{\cos \theta - \sin \theta} \quad (11.3.36)$$

while Θ is uniformly distributed on the interval $[-\pi, \pi]$.

Exercise 11.2 Show that R defined by (11.3.34) has the Rayleigh density

$$f_R(r) = r e^{-r^2/2}, \quad r \in \mathbb{R}_+ \quad (11.3.37)$$

and use this to show (11.3.33). \square

By use of (11.3.7) for unconditioning of (11.3.33) we get the inequality

$$\begin{aligned} & P(R > r, M \leq L | \Theta = \theta) \\ & < K \sqrt{2\pi} \int_0^\infty \left(\frac{1}{\sigma} \right)^{\nu+1} \exp \left[-\frac{\nu}{2} \left(\frac{\beta}{\sigma} \right)^2 \right] d\sigma \int_{-\infty}^\infty \varphi \left(\frac{L - \mu}{\sigma/\psi} \right) \varphi \left(\frac{\mu - \alpha}{\sigma/\sqrt{\nu}} \right) d\mu \\ & < P(R > r | \Theta = \theta) \end{aligned} \quad (11.3.38)$$

valid for $0 \leq \theta < \pi/4$, and in which $\psi = \psi(\theta)$, while K is the normalizing constant belonging to (11.3.7):

$$K = \frac{2\sqrt{2}\beta^{v-1}(v/2)^{v/2}}{\Gamma[(v-1)/2]} \quad (11.3.39)$$

Exercise 11.3 Show (11.3.39) by use of (11.3.17). □

The inner integral in (11.3.38) can be calculated by use of (3.2.21). It becomes

$$\frac{\sigma}{\psi\sqrt{v}\sqrt{1/\psi^2+1/v}} \varphi\left(\frac{L-\alpha}{\sigma\sqrt{1/\psi^2+1/v}}\right) \quad (11.3.40)$$

such that the inequality (11.3.38) by use of the integral formula (11.3.17) becomes

$$\begin{aligned} & P(R > r, M \leq L | \Theta = \theta) \\ & < \frac{K}{\sqrt{\psi^2+v}} \int_0^\infty \left(\frac{1}{\sigma}\right)^v \exp\left[-\frac{v}{2}\left(\frac{\beta}{\sigma}\right)^2 \left\{1 + \frac{\psi^2\lambda^2}{\psi^2+v}\right\}\right] d\sigma \\ & = \sqrt{\frac{v}{\psi^2+v}} \left[1 + \frac{\psi^2\lambda^2}{\psi^2+v}\right]^{-(v-1)/2} \\ & < P(R > r | \Theta = \theta) \end{aligned} \quad (11.3.41)$$

valid for $0 \leq \theta < \pi/4$. From this it follows that

$$\begin{aligned} & P(R > r, M \leq L, \Theta \in [-\pi/4, \pi/4]) \\ & < F(\lambda, v) < P(R > r, \Theta \in [-\pi/4, \pi/4]) \end{aligned} \quad (11.3.42)$$

where

$$F(x, v) = \frac{1}{\pi} \int_0^{\pi/4} \sqrt{\frac{v}{\psi(\theta)^2+v}} \left[1 + \frac{\psi(\theta)^2}{\psi(\theta)^2+v} x^2\right]^{-(v-1)/2} d\theta \quad (11.3.43)$$

is mapped as a function of v for different values of x in Fig. 11.2. It appears from Fig. 11.1 that the right hand side of (11.3.42) is a lower bound to $P(\mathcal{F}_i \cap \mathcal{F}_j)$ while the left hand side of (11.3.42) is equal to $P(\mathcal{F}_i \cap \mathcal{F}_j \cap \{M \leq L\})$. Noting that

$$p_2 = P(\mathcal{F}_i \cap \mathcal{F}_j) = P(\mathcal{F}_i \cap \mathcal{F}_j \cap \{M \leq L\}) + P(\mathcal{F}_i \cap \mathcal{F}_j \cap \{M > L\}) \quad (11.3.44)$$

it thus follows from (11.3.42) that

$$F(\lambda, v) < p_2 < F(\lambda, v) + P(M > L) \quad (11.3.45)$$

where

$$P(M > L) = F_S(-\lambda\sqrt{v-1}; v-1) \quad (11.3.46)$$

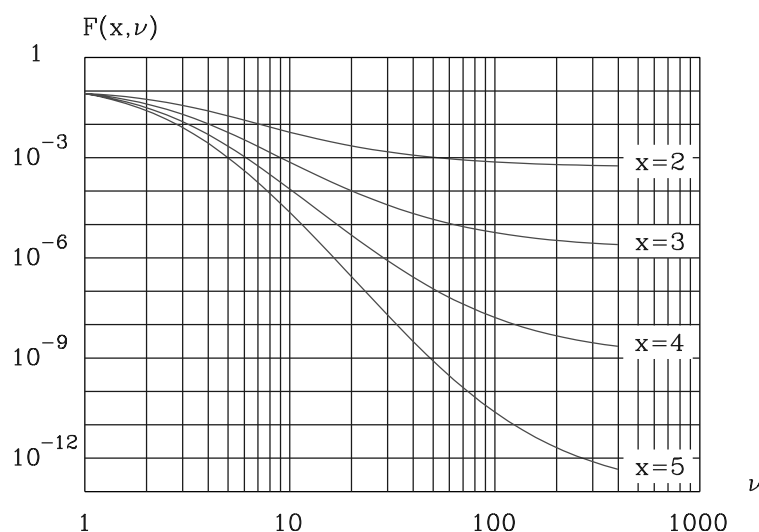

Figure 11.2: Graphs for the function $F(x, \nu)$ defined by (11.3.43). $F(x, \nu) \rightarrow \Phi(-x)^2$ for $\nu \rightarrow \infty$.

according to (11.3.20) and (11.3.21). With $p_1 = P(\mathcal{F}_i)$ and $p_2 = P(\mathcal{F}_i \cap \mathcal{F}_j)$ the inequalities (6.3.12) get the form

$$P(\mathcal{F}) \begin{cases} \geq p_1 \max_{j \in \{1, \dots, m\}} \left\{ j \left[1 - (j-1) \frac{p_2}{2p_1} \right] \right\} & \text{(a)} \\ \leq p_1 \left[m - (m-1) \frac{p_2}{p_1} \right] & \text{(b)} \end{cases} \quad (11.3.47)$$

since the intermediate calculations are the same as the calculations in Example 6.3. The maximal value in (11.3.47)(a) is obtained for j equal to the integer q which is closest to the number $1/2 + p_1/p_2$. If $m < q$ we put $j = m$ in (11.3.47)(a). Since p_2 is determined only by an accuracy given by the bounds in (11.3.45), p_2 in (11.3.47)(a) must be put to the right side of (11.3.45) while p_2 in (11.3.47)(b) must be put to the left side of (11.3.45). For $P(\mathcal{F})$ having a value in the usual domain of values and ν being suitably large the difference between the two sides is negligible. For $m < q$ we thus get

$$P(\mathcal{F}) \geq mp_1 \left[1 - (m-1) \frac{F(\lambda, \nu) + P(M > L)}{2p_1} \right] \quad (11.3.48)$$

while for all m :

$$P(\mathcal{F}) \leq mp_1 \left[1 - \left(1 - \frac{1}{m} \right) \frac{F(\lambda, \nu)}{p_1} \right] \quad (11.3.49)$$

The non-informative prior density (11.3.5) is obtained from (11.3.7) by setting $\nu = 0$. Having a sample of X of size n available and using the non-informative prior density (11.3.5) we shall according to (11.3.8), (11.3.9) and (11.3.10) put

$$\alpha = \bar{x}, \quad \beta = \sqrt{s^2}, \quad \nu = n \quad (11.3.50)$$

in (11.3.48) and (11.3.49). As an example assume that $\lambda = 5$ and $\nu = 20$. From Fig. 11.2 we read $F(5, 20) \approx 2.5 \cdot 10^{-7}$, while $p_1 = F(-4.76; 19) \approx 0.687 \cdot 10^{-4}$ and $P(M > L) = F_S(-21.79; 19) \approx 0$. From (11.3.45) it then follows that $p_2 \approx 2.5 \cdot 10^{-7}$, such that $q = 275$. Thus (11.3.48) and (11.3.49) give

$$\frac{P(\mathcal{F})}{0.687 \cdot 10^{-4} m} \begin{cases} \geq 1 - (m - 1) 3.64 \cdot 10^{-3} / 2 & \text{(a)} \\ \leq 1 - \left(1 - \frac{1}{m}\right) 3.64 \cdot 10^{-3} & \text{(b)} \end{cases} \quad (11.3.51)$$

For $m > 275$ the right side of (11.3.51)(a) is put to 0.50 which is the value that corresponds

m	=	1	10	100	275	500
$10^4 P(\mathcal{F})$	\geq	0.687	6.76	56.3	94.7	171.8
$10^4 P(\mathcal{F})$	\leq	0.687	6.85	68.5	188.2	342.3
β_G	\leq	3.81	3.20	2.53	2.35	2.12
β_G	\geq	3.81	3.20	2.47	2.08	1.82
β_G for	$\nu = \infty$:	5.00	4.54	4.02	3.78	3.63

Table 11.1: Bounds on the generalized reliability index for a structure which is subject to m independent load renewals with identically and normally distributed loads. The parameters of the normal distribution are unknown except for the information given through 20 load observations. The last row of the table corresponds to known values of the parameters.

to $m = 275$. The results are shown in Table 11.1. The last row in the table corresponds to known values of the parameters and $(L - \mu) / \sigma = 5$. The statistical uncertainty is seen to have a considerable influence on the generalized reliability index. \square

Example 11.2 A structural element has the carrying capacity R with respect to the load effect S . Failure occurs if and only if $R < S$. It is assumed that R and S are mutually independent lognormally distributed random variables. The distribution parameters are unknown. However, the sample x_{11}, \dots, x_{1n_1} of $X_1 = \log R$ and the sample x_{21}, \dots, x_{2n_2} of $X_2 = \log S$ are given. The parameter vector $(\mu_1, \mu_2, \sigma_1, \sigma_2)$ in the two-dimensional normal distribution for (X_1, X_2) is assumed to be an outcome of the random vector $(M_1, M_2, \Sigma_1, \Sigma_2)$. A non-informative prior density of $(M_1, M_2, \Sigma_1, \Sigma_2)$ is defined by adopting a diffuse density of $(M_1, M_2, \log \Sigma_1, \log \Sigma_2)$ over all of \mathbb{R}^4 .

It follows then from (11.3.26) that the random variables

$$T_1 = \frac{X_1 - \bar{x}_1}{s_1} \sqrt{\frac{n_1 - 1}{n_1 + 1}}, \quad T_2 = \frac{X_2 - \bar{x}_2}{s_2} \sqrt{\frac{n_2 - 1}{n_2 + 1}} \quad (11.3.52)$$

have predictive densities that are t -densities with $n_1 - 1$ and $n_2 - 1$ degrees of freedom, respectively. Moreover the variables T_1 and T_2 are mutually independent. The failure event $\{X_1 < X_2\}$ can be written as

$$\{X_1 < X_2\} = \left\{ T_1 \cos \omega - T_2 \sin \omega < \frac{\bar{x}_2 - \bar{x}_1}{\sqrt{s_1^2 \frac{n_1 + 1}{n_1 - 1} + s_2^2 \frac{n_2 + 1}{n_2 - 1}}} \right\} \quad (11.3.53)$$

where $0 \leq \omega \leq \pi/2$ and

$$\tan \omega = \frac{s_2 \sqrt{\frac{n_2 + 1}{n_2 - 1}}}{s_1 \sqrt{\frac{n_1 + 1}{n_1 - 1}}} \quad (11.3.54)$$

The predictive distribution of the random variable $T_1 \cos \omega - T_2 \sin \omega$ is called *Behren's distribution with parameter ω and degrees of freedom $(\nu_1, \nu_2) = (n_1 - 1, n_2 - 1)$* . Values of the corresponding distribution function $\text{Beh}(\cdot; \omega, \nu_1, \nu_2)$ are computed most easily by numerical integration of the convolution integral

$$\text{Beh}(t; \omega, \nu_1, \nu_2) = \int_{-\infty}^{\infty} f_S(x; \nu_1) F_S\left(\frac{t - x \cos \omega}{\sin \omega}; \nu_2\right) dx \quad (11.3.55)$$

Behren's density is symmetric with respect to $t = 0$. The generalized reliability index becomes

$$\beta = \Phi^{-1} \left[\text{Beh} \left\{ \frac{\bar{x}_2 - \bar{x}_1}{\sqrt{s_1^2(n_1 + 1)/(n_1 - 1) + s_2^2(n_2 + 1)/(n_2 - 1)}}; \omega, n_1 - 1, n_2 - 1 \right\} \right] \quad (11.3.56)$$

in which ω is given by (11.3.54).

We will illustrate the effect of the statistical uncertainty by applying (11.3.56) on increasing samples drawn independently from two normal distributions with mean values (μ_1, μ_2) and standard deviations (σ_1, σ_2) . The values $\mu_1 = 4\sqrt{2}$, $\mu_2 = 0$, $\sigma_1 = \sigma_2 = 1$ are applied. This implies that $\beta \rightarrow 4$ for $n_1 \rightarrow \infty$ and $n_2 \rightarrow \infty$.

Fig. 11.3 shows 8 independent simulations of the generalized reliability index β given by (11.3.56) for $n_1 = n_2$ (full curves). It is seen that an overestimation of the reliability relative to the complete state of information corresponding to given values of $(\mu_1, \mu_2, \sigma_1, \sigma_2)$ can very well occur. However, generally the reliability is underestimated, in particular for small sample sizes. This is a consequence of the applied non-informative prior distribution which is excessively deviating from the prior distribution used for the 8 simulations. In fact, this distribution is a simple concentrated probability mass at the point $(\mu_1, \mu_2, \sigma_1, \sigma_2) = (4\sqrt{2}, 0, 1, 1)$. The size of the underestimation depends on the limit of the failure probability for $n_1, n_2 \rightarrow \infty$. The smaller the probability is the more pronounced the underevaluation is.

If the principle of long-run revision is followed, the non-informative prior distribution should be updated on the basis of gained experiences. Computationally it is most convenient to choose a prior density from the family of natural conjugate densities (11.3.7) and fit it to the experiences by a suitable choice of the parameters α, β, ν .

The increasing course in broad outline of the curves shows that an increase of the sample size gives a gain in the form of increased reliability. With given design criteria that fix the level of reliability it is therefore possible to obtain increased material savings by increased collection of information.

Fig. 11.3 also shows the curves for those reliability indices that are obtained when σ_1 and σ_2 are assumed to be known (dashed curves). According to (3.2.16) X_1 and X_2 then have predictive

normal distributions with mean values \bar{x}_1 and \bar{x}_2 and variances $\sigma_1^2(1 + 1/n_1)$ and $\sigma_2^2(1 + 1/n_2)$, respectively. The reliability index therefore becomes

$$\beta = \frac{\bar{x}_2 - \bar{x}_1}{\sqrt{\sigma_1^2\left(1 + \frac{1}{n_1}\right) + \sigma_2^2\left(1 + \frac{1}{n_2}\right)}} \tag{11.3.57}$$

The increased information of knowing σ_1 and σ_2 is seen to have an effect in the simulations. It is noted that it can occur that β determined by (11.3.57) becomes less than β determined by (11.3.56).

□

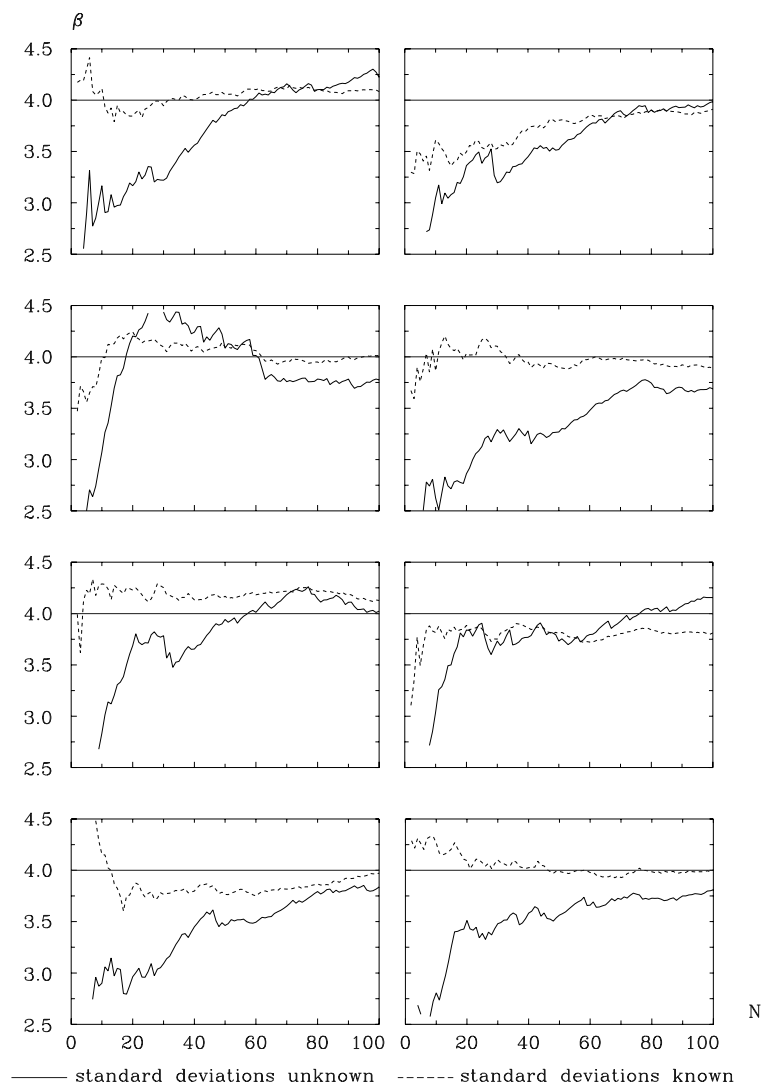

Figure 11.3: Eight realizations of independently generalized reliability indices (11.3.56) and (11.3.57) as functions of the sample size.

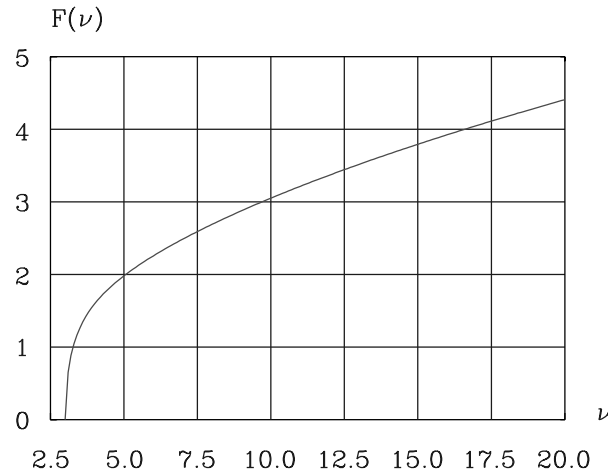

Figure 11.4: Graph for the function $F(v)$ defined by the right side of (11.3.61) (replacing $v + \xi$ by v).

The choice of the parameters α, β, v in the prior density (11.3.7) can be supported by the formulas

$$E[M] = \alpha \quad (11.3.58)$$

$$D[M] = \beta \sqrt{\frac{v + \xi}{v(v + \xi - 3)}} \quad (11.3.59)$$

that follows from (11.3.20), because the standard t -density with v degrees of freedom has the variance $v(v - 2)$. Moreover we have the formula

$$E[\Sigma] = \frac{\Gamma[(v + \xi - 2)/2]}{\Gamma[(v + \xi - 1)/2]} \sqrt{\frac{v + \xi}{2}} \beta \quad (11.3.60)$$

which follows from (11.3.12) by use of the standard formula (11.3.17).

If an engineering judgment can give prudently assessed values for the coefficients of variation V_M and V_X , the approximation

$$\frac{V_X}{V_M} \approx \frac{E[\Sigma]/E[M]}{D[M]/E[M]} = \sqrt{\frac{(v + \xi)(v + \xi - 3)}{2} \frac{\Gamma[(v + \xi - 2)/2]}{\Gamma[(v + \xi - 1)/2]}} \quad (11.3.61)$$

can be used to determine $v + \xi$ since the right side of (11.3.61) is an increasing function of $v + \xi$. The graph of this function is shown in Fig: 11.4. The mean value $E[M]$ is assessed directly so that α is determined by (11.3.58). Finally β is obtained from the formula

$$\beta = \alpha \sqrt{v + \xi - 3} V_M \quad (11.3.62)$$

which follows directly from (11.3.58) and (11.3.59).

11.4 Experimental calibration of mathematical models*

Problem formulation

Let us assume that a deterministic model is formulated for the relation between some given variables y, x_1, \dots, x_m and that this model leads to the formula

$$y_{\text{model}} = f(x_1, \dots, x_m) \quad (11.4.1)$$

where f is a given function of x_1, \dots, x_m . For example, y can be the carrying capacity and x_1, \dots, x_m be material variables or geometric variables. Such a formula is often taken as starting point for the formulation of a probabilistic model. A common way is to replace the input variables x_1, \dots, x_m by the random variables X_1, \dots, X_m in order to define the random variable

$$Y_{\text{model}} = f(X_1, \dots, X_m) \quad (11.4.2)$$

The purpose is to achieve that this random variable becomes correlated (and hopefully strongly correlated) with the corresponding directly observable random variable Y_{measured} .

Let us assume that a sample of $Y_{\text{measured}}, X_1, \dots, X_m$ is observable. Thus a sample of $(Y_{\text{measured}}, Y_{\text{model}})$ can be obtained. The ratio

$$K = \frac{Y_{\text{measured}}}{Y_{\text{model}}} \quad (11.4.3)$$

will only be constant with value 1 if the model is perfect. In general K will vary more or less randomly.

It is reasonable to claim that the model is able to capture the essential dependency between Y_{measured} and (X_1, \dots, X_m) only if either the random variable K has a suitably small coefficient of variation (how small is a question about the practical importance of the accuracy of the model) or if K is uncorrelated with (X_1, \dots, X_m) , or better, is stochastically independent of (X_1, \dots, X_m) .

Assume that X_1, \dots, X_m can be controlled to have given values x_1, \dots, x_m in the experimental situation while Y_{measured} is obtained as a measuring result corresponding to these values. We should then compare Y_{measured} with $y_{\text{model}} = f(x_1, \dots, x_m)$, which leads to the correction factor

$$K(x_1, \dots, x_m) = \frac{Y_{\text{measured}}}{y_{\text{model}}} \quad (11.4.4)$$

The sample of these correction factors can be subject to regression analysis with the purpose of revealing the dependency of K upon x_1, \dots, x_m . The two most commonly considered regression models are the linear model

$$K(x_1, \dots, x_m) = \alpha + \beta_1 x_1 + \dots + \beta_m x_m + R \quad (11.4.5)$$

and the power product model

$$K(x_1, \dots, x_m) = x_1^{\beta_1} \cdot \dots \cdot x_m^{\beta_m} \exp(\alpha + R) \quad (11.4.6)$$

where R is the random residue with mean value zero. The last model is equivalent to the linear model

$$\log K(x_1, \dots, x_m) = \alpha + \beta_1 \log x_1 + \dots + \beta_m \log x_m + R \quad (11.4.7)$$

Therefore let us concentrate on (11.4.7) in the following.

Bayesian linear regression

Assume that the residual term R in (11.4.7) is normally distributed with zero mean and unknown standard deviation σ . From this it follows that $K(\mathbf{x})$ is normally distributed with mean $\alpha + \beta_1 x_1 + \dots + \beta_m x_m$ where (x_1, \dots, x_m) is a free input vector while $\alpha, \beta_1, \dots, \beta_m$ are unknown parameters. By the experimental investigation a sample

$$(\mathbf{x}_1, y_1), (\mathbf{x}_2, y_2), \dots, (\mathbf{x}_n, y_n) \quad (11.4.8)$$

is produced where y_i is the measured value of $Y_i = K(\mathbf{x}_i)$. It is assumed that the random variables Y_1, \dots, Y_n are mutually independent. For given values of $\alpha, \beta_1, \dots, \beta_m, \sigma$ the random variables Y_i is normally distributed with standard deviation σ and mean value

$$E[Y_i | \mathbf{x}_1, \dots, \mathbf{x}_n] = \alpha + \boldsymbol{\beta}^\top \mathbf{x}_i \quad (11.4.9)$$

where $\boldsymbol{\beta}^\top = [\beta_1 \dots \beta_m]$. The likelihood function is

$$L[\alpha, \boldsymbol{\beta}, \sigma; (\mathbf{x}_1, y_1), (\mathbf{x}_2, y_2), \dots, (\mathbf{x}_n, y_n)] = \left(\frac{1}{\sigma}\right)^n \prod_{i=1}^n \varphi\left(\frac{y_i - (\alpha + \boldsymbol{\beta}^\top \mathbf{x}_i)}{\sigma}\right) \quad (11.4.10)$$

Let the parameter vector $(\alpha, \boldsymbol{\beta}, \sigma)$ correspond to a Bayesian random vector (A, \mathbf{B}, Σ) with the prior density

$$f_{A, \mathbf{B}, \Sigma}(\alpha, \boldsymbol{\beta}, \sigma) \propto \left(\frac{1}{\sigma}\right)^{\xi+1} \exp\left[-\frac{\xi}{2} \left(\frac{\delta}{\sigma}\right)^2\right], \quad (\alpha, \boldsymbol{\beta}, \sigma) \in \mathbb{R}^{m+1} \times \mathbb{R}_+ \quad (11.4.11)$$

generalized from (11.3.15) setting $\nu = 0$ and renaming β to δ . After some lengthy algebra the posterior density of (A, \mathbf{B}, Σ) can then be written as

$$\begin{aligned} f_{A, \mathbf{B}, \Sigma}[\alpha, \boldsymbol{\beta}, \sigma | (\mathbf{x}_1, y_1), (\mathbf{x}_2, y_2), \dots, (\mathbf{x}_n, y_n)] &\propto \frac{1}{\sigma} \varphi\left(\frac{\alpha - (\bar{y} - \boldsymbol{\beta}^\top \bar{\mathbf{x}})}{\sigma / \sqrt{n}}\right) \\ &\cdot \left(\frac{1}{\sigma}\right)^{n-m+\xi} \exp\left(-\frac{1}{2\sigma^2} \left[n(c[y, y] - c[\mathbf{x}, y]^\top c[\mathbf{x}, \mathbf{x}^\top]^{-1} c[\mathbf{x}, y]) + \xi \delta^2 \right]\right) \\ &\cdot \left(\frac{1}{\sigma}\right)^m \exp\left(-\frac{1}{2\sigma^2/n} \left(\boldsymbol{\beta} - c[\mathbf{x}, \mathbf{x}^\top]^{-1} c[\mathbf{x}, y]\right)^\top c[\mathbf{x}, \mathbf{x}^\top] \left(\boldsymbol{\beta} - c[\mathbf{x}, \mathbf{x}^\top]^{-1} c[\mathbf{x}, y]\right)\right) \end{aligned} \quad (11.4.12)$$

in which

$$c[y, y] = \frac{1}{n} \sum_{i=1}^n (y_i - \bar{y})^2 \quad (11.4.13)$$

$$c[\mathbf{x}, y] = \frac{1}{n} \sum_{i=1}^n (\mathbf{x}_i - \bar{\mathbf{x}})(y_i - \bar{y}) \quad (11.4.14)$$

$$c[\mathbf{x}, \mathbf{x}^\top] = \frac{1}{n} \sum_{i=1}^n (\mathbf{x}_i - \bar{\mathbf{x}})(\mathbf{x}_i - \bar{\mathbf{x}})^\top \quad (11.4.15)$$

$$\bar{y} = \frac{1}{n} \sum_{i=1}^n y_i \quad (11.4.16)$$

$$\bar{\mathbf{x}} = \frac{1}{n} \sum_{i=1}^n \mathbf{x}_i \quad (11.4.17)$$

The form of the posterior density shows that the random variable

$$U = \frac{A - (\bar{y} - \mathbf{B}^T \bar{\mathbf{x}})}{\Sigma / \sqrt{n}} \quad (11.4.18)$$

hereby becomes standard normally distributed and independent of the vector

$$\mathbf{Z} = \frac{\mathbf{B} - c[\mathbf{x}, \mathbf{x}^T]^{-1} c[\mathbf{x}, y]}{\Sigma / \sqrt{n}} \quad (11.4.19)$$

The vector \mathbf{Z} is seen to be normally distributed with the zero vector as mean value and the covariance matrix $c[\mathbf{x}, \mathbf{x}^T]^{-1}$ (Exercise 4.2). Moreover it is seen that Σ has the posterior density

$$f_{\Sigma}[\sigma | (\mathbf{x}_1, y_1), (\mathbf{x}_2, y_2), \dots, (\mathbf{x}_n, y_n)] \propto \left(\frac{1}{\sigma}\right)^{n-m+\xi} \exp\left(-\frac{ns^2 + \xi\delta^2}{2\sigma^2}\right), \quad \sigma \in \mathbb{R}_+ \quad (11.4.20)$$

where

$$s^2 = c[y, y] - c[\mathbf{x}, y]^T c[\mathbf{x}, \mathbf{x}^T]^{-1} c[\mathbf{x}, y] \quad (11.4.21)$$

As in Exercise 11.1 it is seen that the random variable

$$\frac{ns^2 + \xi\delta^2}{\Sigma^2} \quad (11.4.22)$$

for ξ an integer, has χ^2 -density with $n - m - 1 + \xi$ degrees of freedom.

Exercise 11.4 Student's t -distribution with ν degrees of freedom can be defined as the distribution of the ratio $X/\sqrt{Y/\nu}$ where X and Y are mutually independent random variables, X is standard normally distributed, and Y is χ^2 -distributed with ν degrees of freedom.

Show by use of this result that

$$\frac{A - (\bar{y} - \mathbf{B}^T \bar{\mathbf{x}})}{\sqrt{s^2/\xi + \delta^2/n}} \sqrt{(n-m-1)/\xi + 1} \quad (11.4.23)$$

and each of the elements in the random vector

$$\frac{\mathbf{B} - c[\mathbf{x}, \mathbf{x}^T]^{-1} c[\mathbf{x}, y]}{\sqrt{s^2/\xi + \delta^2/n}} \sqrt{(n-m-1)/\xi + 1} \quad (11.4.24)$$

after multiplication by suitable constants, for ξ an integer, are all t -distributed with $n - m - 1 + \xi$ degrees of freedom. \square

Predictive distribution

For the reliability analysis the predictive distribution of $Y = K(\mathbf{x})$ in (11.4.7) has particular interest. We have

$$f_Y(y | \alpha, \boldsymbol{\beta}, \sigma, \bar{\mathbf{x}}) \propto \frac{1}{\sigma} \varphi\left(\frac{y - (\alpha + \boldsymbol{\beta}^T \bar{\mathbf{x}})}{\sigma}\right) \quad (11.4.25)$$

and thus

$$\begin{aligned} f_Y[y | (\mathbf{x}_1, y_1), (\mathbf{x}_2, y_2), \dots, (\mathbf{x}_n, y_n), \tilde{\mathbf{x}}] &\propto E \left[\frac{1}{\Sigma} \varphi \left(\frac{y - (A + \mathbf{B}^T \tilde{\mathbf{x}})}{\Sigma} \right) \right] \\ &= E \left[\frac{1}{\Sigma} \varphi \left(\frac{y - \hat{e}[y | \mathbf{x}]}{\Sigma} - \frac{1}{\sqrt{n}} U - \frac{1}{\sqrt{n}} \mathbf{Z}^T (\tilde{\mathbf{x}} - \bar{\mathbf{x}}) \right) \right] \end{aligned} \quad (11.4.26)$$

where we have substituted U and \mathbf{Z} defined by (11.4.18) and (11.4.19), and where

$$\hat{e}[y | \mathbf{x}] = \bar{y} + c[\mathbf{x}, y]^T c[\mathbf{x}, \mathbf{x}^T]^{-1} (\tilde{\mathbf{x}} - \bar{\mathbf{x}}) \quad (11.4.27)$$

It is noted that the Bayesian random variables Σ , U and

$$W = \mathbf{Z}^T (\tilde{\mathbf{x}} - \bar{\mathbf{x}}) \quad (11.4.28)$$

are mutually independent and that W is normally distributed with mean value zero and variance

$$\sigma_W^2 = (\tilde{\mathbf{x}} - \bar{\mathbf{x}})^T c[\mathbf{x}, \mathbf{x}^T]^{-1} (\tilde{\mathbf{x}} - \bar{\mathbf{x}}) \quad (11.4.29)$$

With (11.4.26) written as the expectation $E[h(U, W, \Sigma)]$, we have

$$E[h(U, W, \Sigma)] = E[E[h(U, W, \Sigma) | \Sigma]] = E[E[E[h(U, W, \Sigma) | W, \Sigma] | \Sigma]] \quad (11.4.30)$$

see (4.3.20). This scheme for calculation of a mean value by successive determination of conditional mean values (starting "from the inside") is applied to (11.4.26). By use of (3.2.18) we thus find

$$\begin{aligned} E \left[\frac{1}{\Sigma} \varphi \left(\frac{y - \hat{e}[y | \tilde{\mathbf{x}}]}{\Sigma} - \frac{1}{\sqrt{n}} U - \frac{1}{\sqrt{n}} W \right) \right] &= E \left[\frac{1}{\Sigma} \int_{-\infty}^{\infty} \varphi \left(\frac{\dots - u}{\sqrt{n}} \right) \varphi(u) du \right] \\ &\propto E \left[\frac{1}{\Sigma} \varphi \left(\frac{(y - \hat{e}[y | \tilde{\mathbf{x}}]) \sqrt{n} / \Sigma - W}{\sqrt{n+1}} \right) \right] \propto E \left[\frac{1}{\Sigma} \int_{-\infty}^{\infty} \varphi \left(\frac{\dots - w}{\sqrt{n+1}} \right) \varphi \left(\frac{w}{\sigma_W} \right) dw \right] \\ &\propto E \left[\frac{1}{\Sigma} \varphi \left(\frac{(y - \hat{e}[y | \tilde{\mathbf{x}}]) \sqrt{n}}{\Sigma \sqrt{n+1 + \sigma_W^2}} \right) \right] \\ &\propto \int_{-\infty}^{\infty} \left(\frac{1}{\sigma} \right)^{n-m+1+\xi} \exp \left[\frac{ns^2 + \xi \delta^2}{\sigma^2} \left\{ 1 + \frac{(y - \hat{e}[y | \tilde{\mathbf{x}}])^2 n}{(ns^2 + \xi \delta^2)(n+1 + \sigma_W^2)} \right\} \right] d\sigma \end{aligned} \quad (11.4.31)$$

where the posterior density (11.4.20) of Σ is used in the last step. The integral formula (11.3.17) can finally be used in (11.4.31). Thus we get the predictive density

$$f_Y[y | (\mathbf{x}_1, y_1), (\mathbf{x}_2, y_2), \dots, (\mathbf{x}_n, y_n), \tilde{\mathbf{x}}] \propto \left[1 + \frac{(y - \hat{e}[y | \tilde{\mathbf{x}}])^2 n}{(ns^2 + \xi \delta^2)(n+1 + \sigma_W^2)} \right]^{-[(n-m-1+\xi)+1]/2} \quad (11.4.32)$$

which shows that Y with respect to predictive distribution can be written as

$$Y = \hat{e}[y | \tilde{\mathbf{x}}] + T \sqrt{\frac{(ns^2 + \xi \delta^2)(n+1 + \sigma_W^2)}{n(n-m-1 + \xi)}} \quad (11.4.33)$$

$$\rightarrow \hat{e}[y | \tilde{\mathbf{x}}] + T \begin{cases} s \sqrt{(n+1 + \sigma_W^2)/(n-m-1)} & \text{for } \xi \rightarrow 0 \\ \delta \sqrt{1 + (1 + \sigma_W^2)/n} & \text{for } \xi \rightarrow \infty \\ s & \text{for } n \rightarrow \infty \end{cases} \quad (11.4.34)$$

where T , for ξ an integer, is a t -distributed random variable with $n - m - 1 + \xi$ degrees of freedom, see (11.3.25) and (11.3.26) for comparison. It is seen that $Y = K(\mathbf{x})$ depends linearly on \mathbf{x} through the linear regression part $\hat{\varepsilon}[y|\bar{\mathbf{x}}]$ defined by (11.4.27), which according to the theory of linear regression given in Chapter 4 is the linear function that corresponds to the least sum of squared deviations. On top of this there is a non-linear contribution from \mathbf{x} through σ_W^2 . It is given by the quadratic form (11.4.29).

Limit-state formulation

In structural reliability applications, $K(\mathbf{x})$ will typically be a correction to a carrying-capacity formula that should be compared with a load or a load effect S . Let us assume that $K(\mathbf{x})$ is an additive correction so that $K(\mathbf{x})$ is defined by

$$K(\mathbf{x}, T) = Y_{\text{measured}} - y_{\text{model}} \quad (11.4.35)$$

showing explicitly the dependence on the random variable T . Then the equation $Y_{\text{measured}} - S(\mathbf{x}, \mathbf{x}_1) = 0$, that is, the equation

$$R(\mathbf{x}) + K(\mathbf{x}, t) - S(\mathbf{x}, \mathbf{x}_1) = 0 \quad (11.4.36)$$

defines the limit state. In this equation $R(\mathbf{x}) = y_{\text{model}}$ is the carrying-capacity model while $S(\mathbf{x}, \mathbf{x}_1)$ is the relevant load or load effect that may depend on \mathbf{x} and some more input variables collected in \mathbf{x}_1 . The limit state is thus described in the space of $(\mathbf{x}, \mathbf{x}_1, t)$, where t is the extra variable that corresponds to the random part of the model uncertainty concerning $R(\mathbf{x})$. The distribution corresponding to this input variable is then the t -distribution with $n - m - 1 + \xi$ degrees of freedom. In this way the model uncertainty embraces both statistical uncertainty and proper model uncertainty. For $n \rightarrow \infty$ the statistical uncertainty vanishes and a normally distributed model uncertainty remains.

We see that $\sigma_W^2 = 0$ for $\mathbf{x} = \bar{\mathbf{x}}$. If the formula is applied solely within the experimentally covered domain of the \mathbf{x} -space, the value of σ_W^2 will hardly be much larger than $3m$.

Remark 11.1 The upper bound $3m$ for σ_W^2 is obtained by a simple exercise if it is assumed that $\mathbf{x}_1, \dots, \mathbf{x}_n$ are uniformly distributed over a cube centered at the average point $\bar{\mathbf{x}}$, and \mathbf{x} is chosen corresponding to a vertex of this cube. If \mathbf{x} is assumed to be an outcome of a random vector with uniform distribution over the cube, then σ_W^2 has the value m in the mean. \square

In many practical situations the number n is not necessarily large as compared to m . Therefore it is not possible in advance to simplify (11.4.33) by putting σ_W to a suitable constant. It can be stated that the model uncertainty is underestimated if σ_W is put to zero. On the average the value $\sigma_W^2 = m$ will be a usable approximation given that n is reasonably large as compared to m .

It should be emphasized that the considered probabilistic model, besides assuming a normal distribution of the residue, assumes that there is variance homogeneity over the actual domain of variation for \mathbf{x} (in the theory of mathematical statistics this is denoted as the homoscedastic case). Standard textbooks on mathematical statistical theory describe methods for testing the validity of this assumption and also methods for pointing out those variables among the elements in \mathbf{x} that

contribute significantly to the variation of $K(\mathbf{x})$. Among these methods the Bayesian methods are simply based on a check of the position of the set of those parameter vectors $(\beta_1, \dots, \beta_m)$ for which a specified subvector is the zero vector. The position is compared to the posterior distribution of the total parameter vector. If the position is not improbable as judged by the posterior distribution in a specific way, the parameters in question can without obvious inconsistency with the given data be put to zero, that is, the corresponding variables in \mathbf{x} can be removed from the regression model (the principle of simplicity).

The choice of regression model must partly be based on suitable graphical representations of the data and graphical studies of the empirical distribution of the corresponding residuals. Then, for example, it might be possible to see tendencies of deviation from variance homogeneity. Possibly a tendency is seen for the coefficient of variation to be independent of \mathbf{x} so that a logarithmic transformation of the data will lead to the homoscedastic case, see (7.1.5). A non-linear tendency of the mean value variation with respect to \mathbf{x} is not preventing the use of linear regression, of course, since what matters for the application of the given theory is linearity with respect to the parameters $\alpha, \beta_1, \dots, \beta_m$ (and not with respect to \mathbf{x}), and that there is variance homogeneity.

If the sample size n is suitably large, deviations of the distribution of the residual from the normal distribution is less critical when the problem is to obtain usable posterior distributions of the parameters. This can be explained by the central limit theorem. In one of its simplest versions it states that the sum of n mutually independent and identically distributed random vectors with finite covariance matrix asymptotically is normally distributed as $n \rightarrow \infty$. This theorem confirms the experience that statistical methods based on the normal distribution possess a considerable robustness with respect to deviations from the assumed distributions. Guidelines about sample sizes are given in the practical statistical literature but the goodness of approximations may always be tested by Monte Carlo simulation.

Remark 11.2 The mentioned Bayesian test of the hypothesis that some of the elements in \mathbf{x} can be neglected in $K(\mathbf{x})$ gets simple asymptotically as $n + \xi \rightarrow \infty$. Consider the ratio of the maximal value of the m -dimensional t -density function of the Bayesian random vector (11.4.24) to the maximal value of the same t -density function restricted to the subspace of the hypothesis in the space of $\boldsymbol{\beta} = (\beta_1, \dots, \beta_m)$. This density ratio is asymptotically as $n + \xi \rightarrow \infty$ an indicator of the position of the subspace of the hypothesis relative to the m -dimensional posterior density of \mathbf{B} . In fact, as $n + \xi \rightarrow \infty$ the posterior density of (11.4.24) approaches an m -dimensional Gaussian distribution with mean vector zero. Obviously the density ratio is invariant to any linear transformation of the space of $\boldsymbol{\beta}$. In particular we may apply a linear transformation by which the asymptotic Gaussian distribution becomes standardized. Then it is directly seen that the reciprocal of the density ratio asymptotically becomes $\exp[-r^2/2]$ as $n + \xi \rightarrow \infty$, where r is the distance from the origin to the image of the hypothesis subspace by the transformation.

Let the hypothesis subspace be of dimension k . Then the hypothesis subspace is represented by a single point in the $(m - k)$ -dimensional subspace orthogonal to the hypothesis subspace. It is then obvious that solely the posterior density orthogonally projected onto this $(m - k)$ -dimensional subspace is relevant for the judgment of whether the hypothesis is acceptable or not. A reasonable measure of compliance with the hypothesis is then the posterior probability content in the $(m - k)$ -dimensional subspace outside that surface of constant posterior density that passes through the hypothesis point. By the linear mapping that brings the asymptotic Gaussian distribution to the

standardized form as $n + \xi \rightarrow \infty$ the surface of constant posterior density asymptotically becomes the $(m - k)$ -dimensional sphere of squared radius $r^2 = -2 \log$ (posterior density ratio). The probability mass inside this sphere is given by the distribution function of the χ^2 -density with $m - k$ degrees of freedom calculated at r^2 . If this probability is larger than $1 - \epsilon$ for some suitably small ϵ we may decide to reject the hypothesis. In non-Bayesian statistical theory an analogous test is defined as a likelihood ratio test. Asymptotically as $n \rightarrow \infty$ the conclusions from applying any of the two tests are the same. \square

While the remarks about asymptotic normality and robustness are valid for the determination of the posterior distribution of the parameters $\alpha, \beta_1, \dots, \beta_m$, more care must be exercised by the determination of the predictive distribution of $K(\mathbf{x})$ in case the residue is not normally distributed. The actual conditional distribution of $K(\mathbf{x})$ (given the parameter values) should be used while the posterior distribution based on the assumption of normal distribution can be used for unconditioning in case the exact posterior distribution is difficult to obtain. That $K(\mathbf{x})$ in an application cannot be assumed to be normally distributed has particular importance in structural reliability where the tail sensitivity problem (see Example 7.2) even can necessitate standardization in a code of practice of distributional types for some input variables. Typically distribution types for model uncertainty variables (see Chapter 3) that are related to $K(\mathbf{x})$ may be code specified. This may imply that the distributional type for $K(\mathbf{x})$ for $n \rightarrow \infty$ follows from the given standardization implying that the residue gets assigned a conditional distribution (given the parameter values) of code standardized type.

Formulation-invariant representation

The way in which the model uncertainty was represented in Chapter 3 solely by use of random factors or addends to the input variables is not in accordance with the way in which the correction $K(\mathbf{x})$ is introduced in this section. However, there is a very essential reason to keep to the representation of Chapter 3 of the model uncertainties. This is the superior pragmatic consideration which is dictated by the technical mechanical theory itself on which any rational structural reliability analysis necessarily must be based. It is highly expedient that consistent calculations can be made within a well balanced mechanical-physical theory that does not require a book keeping of corrections to very specific formulas obtained in more or less arbitrary experimental situations. This freedom is obtained by using the formulation invariant model uncertainty representation that consists in letting the model uncertainty variables be attached to the input variables in all calculations just in the same way as the partial safety factors are attached to the input variables in the deterministic safety ensuring method. The applications are then based on the hypothesis that the mechanical model possesses sufficient empirical predictive power to allow it to be applied together with the introduced model uncertainty elements to study structural variations that deviate within reasonable limits from the structural designs that have been tested experimentally. If this hypothesis cannot be accepted the consequence is that the applicability of the mechanical theory to a large extend becomes limited and that a long series of structural details must be locked to the designs that have been tested experimentally. Such a restriction seems not to be particularly rational when remembering that the relation between the experimental situation (often a very "ideal" laboratory situation) and the real situation in the actual structure can be very uncertain. Inappropriate limi-

tations of this kind can be seen in the codes of several countries with the result that these codes have developed to be very voluminous containing standardization of a large variety of details. The recent Euro-codes seem not to be of this category.

Besides that pragmatic considerations make us prefer to have the model uncertainties attached to the input variables, the consideration of applicability of the mechanical-physical theory requires that the model uncertainty variables introduced into an applied carrying capacity theory do not become explicitly dependent on geometric quantities that specify the points of attack of the loads on the structure. If this cannot be achieved with sufficient accuracy the carrying capacity theory has doubtful usefulness for the considered field of application.

With this discussion in mind the consequence is that the information obtained by the experiments about $K(\mathbf{x})$ should be transformed to the invariant form. Assume for example that $K(\mathbf{x})$ is defined by

$$\log Y_{\text{measured}} = \log f(\mathbf{x}) + K(\mathbf{x}) \quad (11.4.37)$$

and that x_1 is a material strength variable to which we can attach the model uncertainty on factor form. Then

$$\log f(\mathbf{x}) + K(\mathbf{x}) = \log f[I_1(\mathbf{x})x_1, x_2, \dots, x_m] \quad (11.4.38)$$

from which it follows that

$$I_1(\mathbf{x}) = \frac{1}{x_1} h[\log f(\mathbf{x}) + K(\mathbf{x}), x_2, \dots, x_m] \quad (11.4.39)$$

where h is the function obtained by solving (11.4.38) with respect to $I_1(\mathbf{x})x_1$. From this expression and the given predictive distribution of $K(\mathbf{x})$ the predictive distribution of the model uncertainty factor $I_1(\mathbf{x})$ can be obtained. If a code standardized distribution type is assigned to $I_1(\mathbf{x})$ under the assumption of no statistical uncertainty, it is possible by use of (11.4.38) to determine the distribution type that should be assigned to $K(\mathbf{x})$ and consequently to the residue in the regression model.

11.5 Gradient angle estimation by uniform directional simulation on a cone

Calculations of gradients most often consume the essential part of the calculation time used for first order reliability analysis with respect to elaborate limit-state surfaces in spaces of high dimension. Iterated gradient calculations needed in the search for locally or globally most central limit state points in the standard Gaussian space can be prohibitive for terminating the search within practicable time limits. Therefore explicit response surface approximations are often used as substitutes for elaborate limit-state surfaces, as it is explained in Section 7.6.

A useful response surface is of a sufficiently simple mathematical form to allow a fast determination of the most central point on the response surface itself. Having obtained the most central point B on the response surface, the limit state point C on the line from the origin through B is a

reasonable candidate to take as an approximation to a locally most central limit state point D . Assuming that the limit-state surface is differentiable in a neighbourhood of C , the check of whether C could be a stationarity point of the distance from the origin to the limit-state surface is to determine the direction of the normal vector to the limit-state surface at C . If the direction is coincident with the direction from the origin to C , then C is certainly a stationarity point and possibly a locally most central limit state point D . If the direction only deviates by a small angle from the direction from the origin, a simple approximation to the geometric reliability index can be obtained as the product of the distance to C from the origin and the cosine to the angle.

This section presents a particular directional simulation method that can be used to estimate the deviation angle reasonably well on the basis of maximum likelihood estimation applied to a sample of a suitably defined sampling variable. Even in spaces of high dimension this simulation method gives rather accurate angle estimates only using a very small sample size as compared to the dimension of the space. This property is what is needed for a practicable check procedure in connection with response surface methods where calculation of limit state points are elaborate. In particular, the model-correction-factor method, Section 7.6, gives an illustrative example of the usefulness of the presented combined simulation and maximum likelihood estimation method for verifying that a considered point on the limit-state surface is a locally most central limit state point.

Random unit vector distributed uniformly on spherical cone

Consider a spherical cone with vertex at the origin of the n -dimensional real space and with axis in the direction of the unit vector \mathbf{e}_1 of the first coordinate axis. Let the angle between \mathbf{e}_1 and any generatrix of the cone be γ . Moreover, let $\mathbf{X} = (X_1, \dots, X_n)$ be an n -dimensional standard Gaussian random vector. Then the random directional unit vector

$$\mathbf{A} = \frac{\mathbf{Z}}{\|\mathbf{Z}\|} \quad (11.5.1)$$

where

$$\mathbf{Z} = \mathbf{e}_1 + \frac{\mathbf{X} - X_1\mathbf{e}_1}{\|\mathbf{X} - X_1\mathbf{e}_1\|} \tan \gamma \quad (11.5.2)$$

has a uniform distribution on the intersection between the cone and the unit sphere. Thus it is quite simple to simulate realizations of \mathbf{A} . By simple rotation of the coordinate system the axis of the cone can be directed in any specified direction of the space. Therefore it is sufficient in the following to let the axis direction be coincident with the unit vector \mathbf{e}_1 . We will denote this simulation as uniform unit vector sampling on the γ -cone in direction \mathbf{e}_1 .

Directional distance sampling on a cone

Let $\mathcal{F} \subset \mathbb{R}^n$ be a set with a boundary $\partial\mathcal{F}$ that is cut at most at a single point by any generatrix of the γ -cone in direction \mathbf{e}_1 . The distance to the cut point from the origin in the random direction \mathbf{A} written as $r(\mathbf{A})$ is obtained by solving the equation $g[r(\mathbf{A})\mathbf{A}] = 0$, where $g(\mathbf{x}) = 0$ is the equation

of the boundary surface $\partial\mathcal{F}$. If, in particular, the surface $\partial\mathcal{F}$ is a hyperplane orthogonal to \mathbf{e}_1 at the distance d from the origin, then all values of the sampling variable

$$S = \frac{1}{d} r(\mathbf{A}) \cos \gamma \quad (11.5.3)$$

are 1. However, if $\partial\mathcal{F}$ is a hyperplane through the point $d\mathbf{e}_1$ without being orthogonal to \mathbf{e}_1 then S will show random deviation from 1. In fact, the distribution of S gives information about the normal vector to $\partial\mathcal{F}$ at the point $d\mathbf{e}_1$ given that this point is a point of $\partial\mathcal{F}$ and that $\partial\mathcal{F}$ is flat at this point (in the sense that FORM and SORM give approximately the same generalized reliability index if the normal vector to $\partial\mathcal{F}$ at the point should happen to be coincident with \mathbf{e}_1). Assume that this flatness condition allows to replace the surface $\partial\mathcal{F}$ with a hyperplane that has the normal unit vector \mathbf{n} at an angle ω with \mathbf{e}_1 . Moreover, let γ be chosen such that $2\gamma \ll \pi - 2\omega$. As noted, S is the constant 1 if and only if $\omega = 0$.

The density function of $r(\mathbf{A})$ is determined by using the rotational symmetry of the density of the directional vector \mathbf{A} with respect to \mathbf{e}_1 . Irrespective of the direction of the unit normal vector \mathbf{n} given the angle ω , $r(\mathbf{A})$ has the same probability distribution as if \mathbf{n} is fixed to be the vector $\mathbf{n} = \cos \omega \mathbf{e}_1 + \sin \omega \mathbf{e}_2$. Thus

$$r(\mathbf{A}) =_d \frac{d \cos \omega}{A_1 \cos \omega + A_2 \sin \omega} \quad (11.5.4)$$

where $A_1 = \cos \gamma$ and $=_d$ means equal in distribution. Obviously the second coordinate A_2 of \mathbf{A} has a density on the interval $]-\sin \gamma, \sin \gamma[$ obtained by projecting the uniform density on the surface of the $(n-1)$ -dimensional sphere of radius $\sin \gamma$ on a diameter line of the sphere. By a geometric argument it is thus seen that the density of A_2 is

$$f_{A_2}(x) = \frac{\left[1 - \left(\frac{x}{\sin \gamma}\right)^2\right]^{\frac{n-4}{2}}}{2 \sin \gamma \int_0^1 (1-t^2)^{\frac{n-4}{2}} dt}, \quad -\sin \gamma < x < \sin \gamma \quad (11.5.5)$$

The density of $r(\mathbf{A})$ is hereafter directly obtainable from the relation (11.5.4) as

$$\begin{aligned} f_{r(\mathbf{A})}(r) &= f_{A_2}(a_2) \left| \frac{da_2}{dr} \right| = f_{A_2} \left[\left(\frac{d}{r} - \cos \gamma \right) \frac{1}{\tan \omega} \right] \frac{d}{r^2 \tan \omega} \\ &= \frac{\left(\frac{d}{r} \right)^2 \left[1 - \left(\frac{d/r - \cos \gamma}{\sin \gamma \tan \omega} \right)^2 \right]^{\frac{n-4}{2}}}{2d \tan \omega \sin \gamma \int_0^1 (1-t^2)^{\frac{n-4}{2}} dt}, \quad \frac{\cos \omega}{\cos(\omega - \gamma)} \leq \frac{r}{d} \leq \frac{\cos \omega}{\cos(\omega + \gamma)} \end{aligned} \quad (11.5.6)$$

where-upon the density of the sampling variable S is obtained from (11.5.3) as

$$f_S(s) = \frac{\left(\frac{1}{s} \right)^2 \left[1 - \left(\frac{1/s - 1}{\tan \gamma \tan \omega} \right)^2 \right]^{\frac{n-4}{2}}}{2 \tan \gamma \tan \omega \int_0^1 (1-t^2)^{\frac{n-4}{2}} dt}, \quad 1 - \tan \gamma \tan \omega \leq \frac{1}{s} \leq 1 + \tan \gamma \tan \omega \quad (11.5.7)$$

Maximum likelihood estimation of the angle

Let s_1, \dots, s_m be a sample of S using a sample $\mathbf{z}_1, \dots, \mathbf{z}_m$ of the random vector \mathbf{Z} generated by use of (11.5.2). The loglikelihood function for ω then becomes

$$L[\omega | s_1, \dots, s_m] = \sum_{i=1}^m \log[f_S(s_i | \omega)] \quad (11.5.8)$$

and it is defined for $0 \leq \omega < \frac{\pi}{2} - \gamma$. A point estimate of ω is the point of maximal loglikelihood.

To test the applicability of this method of estimating the angular deviation of the normal vector \mathbf{n} from the first axis unit vector \mathbf{e}_1 , some example calculations are shown in the following. It is the idea of this simulation method, of course, that the number of calculations of $r(\mathbf{A})$ should be considerably less than that needed for deterministic numerical calculation of the normal vector, that is, considerably less than the dimension n of the space. Within the range of small values of ω the method is anticipated to be effective simply because the sampling variable S becomes the constant 1 for $\omega = 0$ and a plane surface $\partial\mathcal{F}$.

This is the asymptotic verification situation often met when applying response surface methods for reliability analysis with elaborate limit-state surfaces in high dimensions. In the next section a particular response surface method is considered for demonstration of the need. This particular method has been called the model-correction-factor method because it is based on a simplified physical modelling of the limit state. By correction factoring it becomes a response surface of closer resemblance to the elaborate limit-state surface than an arbitrary non-physical second or third degree algebraic surface.

As the test example the hyperplane with the normal unit vector $\mathbf{n} = \cos\omega \mathbf{e}_1 + \sin\omega \mathbf{e}_2$ is taken. Then $r(\mathbf{A})$ is simply calculated by the right side of (11.5.4). Figure 11.5 shows the graphs of different loglikelihood functions corresponding to $\gamma = 0.1$, the space dimensions $n = 10, 50, 100, 500$, and angles ω corresponding to $\tan\omega = 0.05, 0.1, 0.2, 0.4, 0.8$. The sample sizes m are given as $m/n = 0.02, 0.1, 0.2, 0.4, 0.8$ (given $m > 1$). The lowest graph in each diagram corresponds to the smallest sample size (required to be larger than 1, of course) and the graphs become placed in monotoneous order from bottom to top according to increasing sample size. Since only the determination of the positions of the maximum points on the $\tan\omega$ -axes is of interest, no units are marked on the ordinate axes.

It is seen that this simulation method is quite effective as a tool to estimate the unknown angle ω , in particular for the larger dimensions n where the tool is actually needed. It is also seen that rather small sample sizes as compared to the dimension of the considered space are sufficient to obtain reasonably accurate estimates. The same test examples tried for $\gamma = 0.05$ and 0.2 show that the value of γ has negligible influence on the maximum likelihood estimates of ω .

Application to model-correction-factor method

A check and possible correction for being out of tangency can be made by replacing the effectivity factor $v(\mathbf{x})$ by its first-order Taylor expansion at the limit point \mathbf{x} . This requires a determination of the normal vector \mathbf{n} to the elaborate limit-state surface at \mathbf{x} . A numerical determination takes as

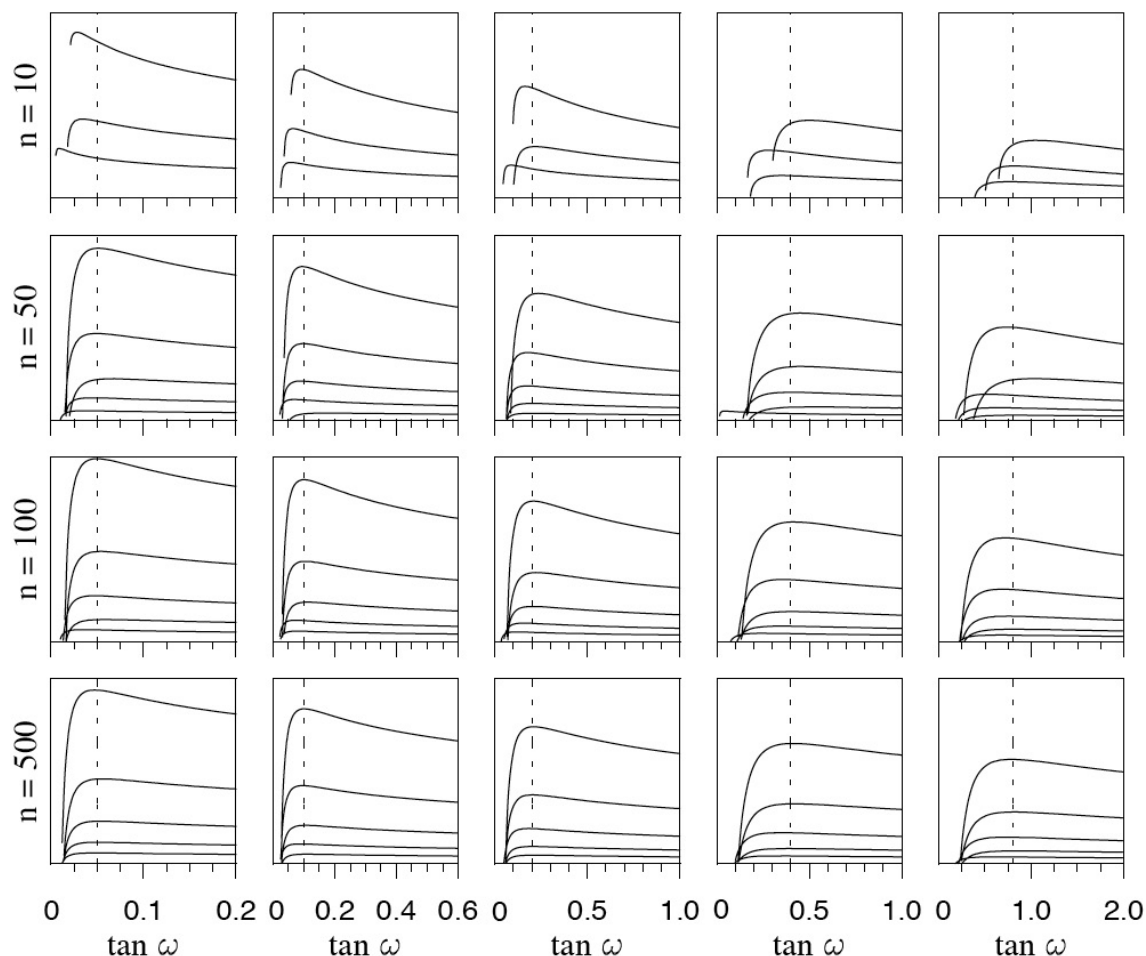

Figure 11.5: Graphs of loglikelihood functions for $\tan \omega$ obtained by test simulations with known angular deviation ω of hyperplane normal vector from first axis unit vector (marked by the vertical dotted lines). The space dimension is n and the sample size m is (top down) 0.8, 0.4, 0.2, 0.1, 0.02 times n given $m > 1$, respectively.

many calculations of points on the elaborate limit-state surface in the vicinity of \mathbf{x} as the dimension of the space. This can be prohibitively time consuming.

To verify that there is tangency or only minor deviation from tangency it can therefore be advantageous as a practicable alternative to apply the simulation method presented above. Given that the elaborate limit-state surface is almost flat at the most central limit state point and the angle between the two limit-state surfaces is small, then an estimate of the geometric reliability index is

$$\beta = \|\mathbf{x}\| \cos \hat{\omega} \quad (11.5.9)$$

where $\hat{\omega}$ is the estimate of the angle ω . By making simple test simulations the smallest needed sample size that is likely to provide sufficient accuracy in a given application can be estimated before the start of time consuming calculations of points on the elaborate limit-state surface.

Relying on the similarity between the two surfaces, the flatness can be judged by comparing the reliability results obtained by applying both FORM (curvature independent results) and SORM (curvature dependent results) to the idealized limit-state surface. Another possibility is to test whether there are significant deviations of the simulated sample from the distribution (11.5.7) obtained from the hyperplane assumption.

11.6 Historical and bibliographical notes

It is outside the frame of this book to deal with the historical development of the Bayesian statistical theory. For this the topic is far too large and the literature overwhelming. It should just be mentioned that D.V. Lindley's elementary text book from 1965 [11.5] has been a special inspiration for the authors of this book. The same is true with respect to the book of J.R. Benjamin and C.A. Cornell from 1970 [11.1] due to its engineering relevance.

Consideration of statistical uncertainty by the definition of the reliability index was first discussed by D. Veneziano [11.7] in 1975, who suggested to base the definition on predictive distributions. Since then this principle has been widely accepted among most of the supporters of the Bayesian interpretation of the concept of probability. Among the contributors to applications of the Bayesian methods on problems related to structural reliability should R. Rackwitz be mentioned for several specific applications [11.6].

There are also several engineering philosophers who are critical to the reliability index definition as given in this chapter as the generalized reliability index calculated by use of the predictive distributions. The critical attitude is related to some specific properties of the von Neumann-Morgenstern decision theory introduced in the next chapter. Objections by A. Der Kiureghian [11.4] are among other things based on studies of the problem in Example 11.2. Other philosophical problems are related to the problem of choosing reasonable models of non-informativeness in terms of prior distributions, S. Engelund and R. Rackwitz [11.3].

The method of gradient angle estimation by uniform simulation on a cone in Section 11.5 is due to O. Ditlevsen [11.2].

Bibliography

[11.1] J.R. Benjamin and C.A. Cornell (1970) *Probability, Statistics and Decision for Civil Engineers*. McGraw-Hill, New York.

[11.2] O. Ditlevsen (1997) Gradient angle estimation by uniform directional simulation on a cone. Proc. of IFIP 7th WG 7.5 Working Conference on Reliability and Optimization of Structural Systems, April, 1996, Boulder, Colorado, USA. Pergamon, 127-132.

[11.3] S. Engelund and R. Rackwitz (1992) On predictive distribution functions for the three asymptotic extreme value distributions, *Structural Safety*, **11**, 255-258.

[11.4] A. Der Kiureghian (1989) Measures of structural safety under imperfect states of knowledge, *Journal of Structural Engineering*, **115**, 1119-1140.

[11.5] D.V. Lindley (1965) *Introduction to Probability and Statistics*, pt. 2, *Inference*. Cambridge, London.

[11.6] R. Rackwitz (1983) Predictive distribution of strength under control, *Materials & Structures*, **16**, 259-267.

[11.7] D. Veneziano (1975) A theory of reliability which includes statistical uncertainty, *Proceedings, Applications of Statistics and Probability in Soil and Structural Engineering (ICASP2)*, 2nd International Conference, Vol.1, Aachen, F.R. Germany, 231-250.

Chapter 12

DECISION PHILOSOPHY

12.1 The decision problem

The theory of structural reliability described in the previous chapters does not in itself give rules for the choice of the reliability level. The open problem is what level should be required in order that the structure in the light of the available information about the structure and the actions on it can be declared to be sufficiently safe. Without the existence of a universal consensus it is a wide spread attitude shared by the authors that the safety level that through previous design practice has become acceptable to the society should not be changed drastically when an authority introduces a new code of practice or revises an old code. Changes should be made in a prudent evolutionary way taking start from a calibration to existing design practice.

On the other hand, it is obvious that it is necessary to formulate some superior principles for rational control of this evolution of the reliability level. For example, it seems to be a rational attitude to let the acceptable reliability level with respect to some adverse event be dependent on the consequences that follows from the adverse events, that is, of the degree of damage caused by the event. In order to appreciate the nature of these problems we will in the following consider the basic features of that theory of decision making that was formulated in USA during the second world war by von Neumann and Morgenstern, [12.2].

First we must make clear that a decision leads to an action that implies some consequences. The realization of a project for a structure has several consequences of which one is a consumption of capital that in size varies with the structural design. Other consequences are failures and non-failures of different types, durability consequences, etc. It is only for very simple decision situations that the actions lead to unique consequences. Generally the effect of the action is that a lottery (a game) is run between the consequences in the sense that the action picks out a specific probability distribution from a given set of probability distributions over the set of possible consequences. For example, a choice between different bar types and bar dimensions in a truss structure corresponds to a choice from a set of strength distributions and corresponding prices. Each choice is indirectly a choice between probability distributions over the set of consequences which is relevant for the truss structure. The elements in the set of probability distributions over the consequences are in the decision theory formally denoted as lotteries between the consequences. Thus a lottery is a weighted set of consequences.

The basic idea in the decision theory by von Neumann and Morgenstern is that the decision maker formulates his or her “personal” preferences by defining a utility function on the set of consequences. A considered consequence of given utility is preferred to any other consequence of lower utility. Through some few “self-evident” axioms this utility function is extended to the set of all lotteries between the consequences. In this line of thinking the set of consequences are naturally identified with the set of those trivial lotteries that each has an atomic (zero-one) probability distribution. By this a preference ordering is introduced in the set of lotteries between the consequences. This ordering obviously induces a preference ordering in the set of relevant decisions. If it exists, the best decision is the one for which the corresponding lottery has the largest utility.

By the application of such a decision theory as the basis for the choice of the acceptable reliability level of a structure the personal preference of the design engineer should be regulated normatively. The normative fixing of the acceptable reliability level is thus replaced by normative value specifications of certain elements that define the relevant utility functions. Structural codes with specifications of this kind do not exist presently, but it would be quite useful to have such codes in particular to guide decisions that concern restorations or changes of existing structures. This topic is considered in Chapter 13.

If taken for given that rationality and optimal action behavior should characterize engineering activity and a code is not prescribed for this activity, then there is hardly any way by which utility value considerations can be avoided. By a particular interpretation, the consequence calculation principle gives a possibility of obtaining support from the existing codes of practice. The necessary condition for this is that it is accepted that the existing codes reflect presently optimal engineering decision making. However, analyses of a representative population of different structures with judgementally the same failure consequences and all designed according to present codes of practice show that the optimality postulate is not consistent with utility uniformity of the structures.

Let us make the supposition that there in a given country (or union of cooperating countries) is a decision maker (a committee, say) that possesses superior authority with respect to deciding what is optimal structural design. This decision maker is imagined to be asked to point out a specific structure type (structural element type, say) that will get optimal dimensions if it is designed to the limit according to a given partial safety factor code and a specific ultimate limit state model both specified by the authority itself. This means that the superior authority by answering this question implicitly evaluates the intangible socio-economic cost of adverse behavior of the considered structure type such that any stronger or weaker design will have a larger total cost than that of the optimal design. In fact, if the decision theory of von Neumann and Morgenstern is accepted as a valid principle of decision making the evaluation of the socio-economic costs of the different possible consequences of the decision is precisely the task of the decision maker. The minimization of the total expected cost then leads to the optimal decision. With the optimal decision given the intangible cost of adverse behavior can therefore be backcalculated under the adoption of a specific probabilistic code. In this way having calibrated the intangible cost of the design decision problem to the authoritative declaration of optimality, the future design decisions for the considered structure type can be based on rational decision theory implemented within the given probabilistic code.

Even though the superior authority might admit that its partial safety factor code may be too

simplified to have the potential of giving optimal designs for all the structure types for which the code is used, there should be at least one structure type within the domain of the code that by the authority is considered to be optimally designed. Otherwise the authority is not self-consistent and as the proper authority it should therefore change the value settings of the code. Therefore the outlined strategy for setting up a probabilistic code that can be approved by the superior authority seems reasonable. However, more detailed analysis reveals several problems that require authoritative decisions.

The first problem to be illustrated in Example 12.1 is that the authority is not asked which specific structure of the considered type is the optimal structure. Of course, such a question can be asked, but as it will become evident in the following it is not necessary and hardly wise to require such a specific and difficult question to be directly answered by the authority. By only declaring optimality for the specified structure type class as such it turns out that for a given probabilistic code there is a considerable uncertainty about the value of the optimal reliability index. It will be shown in Example 12.4 that this problem can be solved in a rational way by a decision theoretical argument.

Example 12.1 For a standard type plane tubular joint in an offshore structure the limit state with respect to failure of the joint is often modeled by an empirically based equation of the form

$$1 - \frac{P}{P_u} - \left(\frac{M}{M_u}\right)^{\alpha_1} - \left(\frac{N}{N_u}\right)^{\alpha_2} = 0 \quad (12.1.1)$$

in which P is an internal normal force, M is an internal moment in the plane of the joint, and N is an internal moment orthogonal to the plane. The corresponding strength variables are the random variables P_u , M_u , and N_u , respectively. Further details about the geometry and mechanical behavior of the joint are not needed in this example. The internal forces are assumed to be given as a linear function

$$\begin{bmatrix} P \\ M \\ N \end{bmatrix} = \begin{bmatrix} c_{11} & c_{12} & c_{13} & c_{14} & c_{15} \\ c_{21} & c_{22} & c_{23} & c_{24} & c_{25} \\ c_{31} & c_{32} & c_{33} & c_{34} & c_{35} \end{bmatrix} \begin{bmatrix} G \\ Q \\ S \\ V \\ W \end{bmatrix} = \mathbf{C} \begin{bmatrix} G \\ Q \\ S \\ V \\ W \end{bmatrix} \quad (12.1.2)$$

of the five random load variables G (self weight), Q (operational load), S (snow and ice load), V (wind load), and W (wave and current load).

All eight random variables are assumed to be mutually independent even though this assumption may not be fully realistic. In particular the three strength variables could be mutually dependent as also the nature loads S , V , and W could be dependent. However, for the purpose of this illustration these possible dependencies are not essential.

Moreover the problem is simplified by assuming that the powers α_1 and α_2 are deterministic: $\alpha_1 = 2.1$, $\alpha_2 = 1.2$. The eight random variables have distributions and parameters as given in the Table 12.1

In Table 12.1, N denotes normal distribution and LN denotes lognormal distribution. The common expectation θ of the strength variables is taken as the design variable ideally to be determined such that the joint gets a prespecified reliability with respect to the limit state (12.1.1).

Table 12.1: Data for Example 12.1

Variable	P_u	M_u	N_u	G	Q	S	V	W
Distribution	LN	LN	LN	N	N	N	N	N
Expectation*	θ	θ	θ	1	1	1	1	1
Coeff. of var.	0.20	0.25	0.25	0.05	0.15	0.20	0.25	0.30

* with a suitable physical unit.

We now make the supposition that the joint is chosen at random among all the joints in a large offshore structure. This means that the influence matrix \mathbf{C} in (12.1.2) is an outcome of a random matrix. It is assumed that the value of the design variable θ for the chosen joint is obtained according to the Danish offshore code (DS 449) (the format of which is similar to the general format of the Euro-codes). Thus θ is determined as the largest of the five values obtained according to the five design load combinations:

$$\begin{bmatrix} p_{d1} \cdots p_{d5} \\ m_{d1} \cdots m_{d5} \\ n_{d1} \cdots n_{d5} \end{bmatrix} = \mathbf{C} \begin{bmatrix} g_c \\ q_c \\ s_c \\ v_c \\ w_c \end{bmatrix} \begin{bmatrix} \gamma_g & \gamma_g & \gamma_g & \gamma_g & 1.15 \\ \gamma_f & \psi_q & \psi_q & \psi_q & 0 \\ \psi_s & \gamma_f & \psi_s & \psi_s & 0 \\ \psi_v & \psi_v & \gamma_f & \psi_v & 0 \\ \psi_w & \psi_w & \psi_w & \gamma_f & 0 \end{bmatrix} \quad (12.1.3)$$

substituted together with the design values $p_{ud} = p_{uc}/\gamma_m$, $m_{ud} = m_{uc}/\gamma_m$, $n_{ud} = n_{uc}/\gamma_m$ of the resistance variables into the limit-state equation (12.1.1). The characteristic values p_{uc} , m_{uc} , n_{uc} are defined as the 5%-fractiles of the distributions of P_u , M_u , N_u , respectively. For the data given in the table these characteristic values are $[p_{uc} \ m_{uc} \ n_{uc}] = \theta[0.708 \ 0.647 \ 0.647]$. The material strength partial safety factor is put to $\gamma_m = 1.2$.

The second matrix on the right side of (12.1.3) is a diagonal matrix with the characteristic values g_c , q_c , s_c , v_c , w_c of the loads G , Q , S , V , W in the diagonal. Except for the self-weight G these characteristic values are defined as the 98%-fractile in the distribution of the yearly extreme, while g_k is defined as the 50% fractile. Thus $[g_c \ q_c \ s_c \ v_c \ w_c] = [1.000 \ 1.308 \ 1.411 \ 1.514 \ 1.616]$. The last matrix in (12.1.3) contains the partial coefficients γ_g and γ_f on self-weight and variable load, respectively, and the load combination factors ψ_q , ψ_s , ψ_v , ψ_w , see Chapter 2. These factors are put to $\gamma_g = 1.0$, $\gamma_f = 1.3$, $\psi_q = 1.0$, $\psi_s = \psi_v = \psi_w = 0.5$.

To investigate how much it can be expected that the reliability varies among the joints of the considered offshore structure given that they are all designed according to the partial safety factor code defined here, it is assumed as an example that the 15 influence numbers in \mathbf{C} are mutually independent and uniformly distributed between 0 and 1. Bjerager [12.1] considered this example and simulated 1000 outcomes of \mathbf{C} , and for each of these the design parameter value θ and thereafter the geometric reliability index β were calculated. The obtained sample of 1000 β -values turned out to be reasonably well described by a normal distribution of mean $\mu \simeq 4.40$ and a standard deviation of $\sigma \simeq 0.30$. Thus there is a considerable variability of the reliability index resulting from constant partial safety factor design. The size of this variability is comparable in size with the difference between two neighboring safety classes as they are defined by NKB [2.4]. The difference between high safety class and normal safety class is expressed by a difference in the β -level of 0.5 (see Table 1 of Appendix 3).

On the basis of this result it is seen that the probability of occurrence of failure within one year of a randomly chosen joint is

$$p_f = \frac{1}{\sigma} \int_{-\infty}^{\infty} \Phi(-\beta) \varphi\left(\frac{\beta-\mu}{\sigma}\right) d\beta \approx 1.25 \times 10^{-5} \quad (12.1.4)$$

with the corresponding reliability index

$$\beta_{\text{class}} = \Phi^{-1}(p_f) = 4.21 < E[\beta] = 4.40 \quad (12.1.5)$$

The problem is now whether the optimal target reliability index β_t should be chosen as β_{class} or whether it should be some other value of β . One argument could be that since the society (the legislation authority) has accepted that the fraction x of the joints according to the present code has a reliability index smaller than $\beta(x) = \mu + \sigma\Phi^{-1}(x)$, then $\beta(x)$ should in principle be acceptable as target reliability index if x is not too small ($x = 25\%$, for example). However, the problem is not solved before some rational principle of choosing x is established. We return to the problem in Example 12.4. \square

12.2 The von Neumann and Morgenstern axioms for preference ordering

Let \mathcal{C} be the set of consequences in a given decision problem and let \mathcal{L} be the set of lotteries between the consequences in \mathcal{C} . If \mathcal{C} is a finite set, it is convenient to use the following formal notation

$$L = \alpha_1 C_1 + \cdots + \alpha_n C_n \quad (12.2.1)$$

for a lottery between the consequences $C_1, \dots, C_n \in \mathcal{C}$ where

$$\alpha_i = E[\mathbf{1}_{C_i}], \quad i = 1, \dots, n \quad (12.2.2)$$

is the probability to get the consequence C_i and $\alpha_1 + \cdots + \alpha_n = 1$. Note that the consequences are defined such that two different consequences C_i and C_j cannot occur together as a result of a single run of the lottery L . Since $C_i = 0 \cdot C_1 + \cdots + 0 \cdot C_{i-1} + 1 \cdot C_i + 0 \cdot C_{i+1} + \cdots + 0 \cdot C_n \in \mathcal{L}$ the consequences are also called the *trivial* lotteries.

In the more common case where the set of consequences \mathcal{C} is infinite the consequences may be indexed by $t \in [0, 1]$ and written as $C(t)$. Then the notation (12.2.1) is directly generalized to

$$\int_0^1 C(t) dF(t) \quad (12.2.3)$$

for a lottery between the consequences (or, equivalently, between the trivial lotteries called so because $C(t) = \int_0^1 C(\tau) \delta(\tau - t) d\tau$ where $\delta(\cdot)$ is Dirac's delta function, that is, the probability is 1 of getting the consequence $C(t)$). In this notation $dF(t)$ is the probability that the trivial lottery $C(t)$ is the outcome of the lottery between the trivial lotteries. If there exists no trivial lottery corresponding to t , then the corresponding probability increment $dF(t)$ is set to zero.

In a similar way a lottery between m lotteries L_1, \dots, L_m is written as

$$L = \gamma_1 L_1 + \dots + \gamma_m L_m \quad (12.2.4)$$

where

$$\gamma_j = E[\mathbf{1}_{L_j}], \quad j = 1, \dots, m \quad (12.2.5)$$

is the probability that the lottery L_j is drawn and where $\gamma_1 + \dots + \gamma_m = 1$. A lottery between lotteries from \mathcal{L} is called a *composite lottery*. The symbolism (12.2.4) is convenient because according to the probability calculus the composite lottery can be written as

$$L = \left(\sum_{j=1}^m \gamma_j \alpha_{1j} \right) C_1 + \dots + \left(\sum_{j=1}^m \gamma_j \alpha_{nj} \right) C_n \quad (12.2.6)$$

which also is obtained by formal symbol manipulation with the right hand side of

$$L = \sum_{j=1}^m \gamma_j \left(\sum_{i=1}^n \alpha_{ij} C_i \right) \quad (12.2.7)$$

In case \mathcal{C} is infinite, the formal notation

$$\int_0^1 C(t) dF(t|s) \quad (12.2.8)$$

symbolizes a possibly infinite set of non-trivial lotteries indexed by $s \in [0, 1]$. A composite lottery between the lotteries in this set is defined by a probability distribution function $G(s)$ and is by direct generalization of (12.2.4) written as

$$\int_{s=0}^1 \left[\int_{t=0}^1 C(t) dF(t|s) \right] dG(s) = \int_{t=0}^1 C(t) \int_{s=0}^1 dF(t|s) dG(s) \quad (12.2.9)$$

The right side is obtained by interchanging the order of the integral signs just as if the double integral was an ordinary integral. As in (12.2.6) this operation is consistent with the total probability theorem by which the probability of getting the consequence $C(t)$ is the integral with respect to s of the product of the conditional probability increment $dF(t|s)$ given that $S = s$ and the probability $dG(s)$ of the event $s \leq S < s + ds$. Thus the integral notation consistently indicates that the composite lottery is a lottery between the trivial lotteries with the lottery probability $\int_{s=0}^1 dF(t|s) dG(s)$ assigned to the trivial lottery $C(t)$.

The first step the decision maker has to take is that he or she must define a preference ordering “ $<$ ” in \mathcal{C} such that the following properties are accepted by the decision maker. Let $A, B, C \in \mathcal{C}$. If B is preferred to A and C is preferred to B , then C is preferred to A (the ordering is *transitive* $A < B \wedge B < C \Rightarrow A < C$). If B is preferred to A and A is preferred to B , then there is indifference with respect to A and B , and it is said that A and B are *equivalent*. This is written $A \sim B$ (the ordering is *antisymmetric*: $A < B \wedge B < A \Rightarrow A \sim B$).

The assumption about transitivity can in certain decision situations be doubtful. Lack of transitivity can imply that an optimal decision cannot be made. Problems of this kind can occur

in particular when the decision maker is a group of persons with democratic rules of voting and where the members of the group have conflicting preferences. Example: Let each of the preference orderings $A < B < C$, $B < C < A$, $C < A < B$ get one third of the votes assuming that all members of the group accept the transitivity rule. Then all the preferences $A < B$, $B < C$, $C < A$ have two thirds of the votes while the preferences $A < C$, $B < A$, $C < B$ have one third of the votes. By a majority decision rule the preferences $A < B$, $B < C$, $C < A$ are all accepted. Thus the transitivity is lost.

Having solely a preference ordering of \mathcal{C} is naturally not particularly useful since the choice in practice is between lotteries in \mathcal{L} that usually do not belong to \mathcal{C} . Thus the decision maker looks for an *extension* of the preference ordering from \mathcal{C} to \mathcal{L} . At this point the difficulties become serious for the decision maker because he or she cannot make a choice without being confronted with both *pro et contra*. Von Neumann's and Morgenstern's idea is to get around the problem by formulating some simple axioms for rational decision making in such a way that these axioms by mathematical necessity lead to a unique extension of the preference ordering from \mathcal{C} to \mathcal{L} . Accepting the statements of the axioms the decision maker is thus released from this difficult weighing problem.

It turns out, though, that the decision maker cannot get around by just choosing the preference ordering in \mathcal{C} . He or she must also assign relative weights to the consequences in \mathcal{C} . It is not sufficient to state that $A < B$. The decision maker must also make up his or her mind of how much B is preferred to A . Thus it is necessary to put all the consequences on a value scale by the aid of a suitable function $u: \mathcal{C} \rightarrow \mathbb{R}$ that does not just preserve the preference ordering by satisfying the condition

$$A < B \Leftrightarrow u(A) \leq u(B) \tag{12.2.10}$$

but where the values express the relative utilities to the decision maker of the different consequences. The function $u: \mathcal{C} \rightarrow \mathbb{R}$ is therefore called the decision maker's *utility function*. However, the origin and the unit of the utility value scale make no importance for the decision process. The problem of the extension of the preference ordering from \mathcal{C} to \mathcal{L} can hereafter alternatively be formulated as a problem about the extension of the utility function from \mathcal{C} to \mathcal{L} .

In the following it is assumed with sufficient generality that $u(t)$ is an increasing function of $t \in [0, 1]$ corresponding to the decision maker's preference ordering of the set of all trivial lotteries. To the index value t then corresponds all lotteries with utility $u(t)$. These trivial lotteries are all equivalent and no trivial lotteries with utilities different from $u(t)$ are equivalent to any of the lotteries with utility $u(t)$. The first axiom of Von Neumann and Morgenstern helps the decision maker to choose the utilities of the trivial lotteries:

Axiom 1: For any trivial lotteries $A < B < C$ where A and C are not equivalent, there is a unique probability $\alpha \in [0, 1]$ such that

$$B \sim \int_0^1 [A(1 - \alpha)\delta(t - t_A) + C\alpha\delta(t - t_C)] dt = (1 - \alpha)A + \alpha C \tag{12.2.11}$$

where $\delta(\cdot)$ is Dirac's delta function, and $t_A < t_C$ are the index values of A, C , respectively. The notation on the right side of (12.2.11) is directly interpretable as a lottery between A and C with the probability $1 - \alpha$ of getting A and α of getting C .

The decision maker may now choose to let the utility function $u(t)$ be defined such that the utility of B becomes equal to the expected utility of the equivalent lottery $(1 - \alpha)A + \alpha C$, that is,

$$u(t_B) = (1 - \alpha)u(t_A) + \alpha u(t_C) \quad (12.2.12)$$

Defined in this way $u(t_B)$ is a convex linear combination of $u(t_A)$ and $u(t_C)$, implying that the ordering $u(t_A) \leq u(t_B) \leq u(t_C)$ is preserved. As stated by Axiom 1 the decision maker *chooses* the probability α and then *defines* the utility $u(t_B)$ of the trivial lottery B such that $u(t_B)$ equals the expected value of the random utility $u(T)$ of the equivalent lottery $(1 - \alpha)A + \alpha C$. If the decision maker *chooses* the utilities $u(t_A) \leq u(t_B) \leq u(t_C)$ as expected utilities with $u(t_A) < u(t_C)$, then he or she must accept the equivalence (12.2.11) with

$$\alpha = \frac{u(t_B) - u(t_A)}{u(t_C) - u(t_A)} \quad (12.2.13)$$

It is now quite natural to define the utility $U(L)$ of any lottery $L = \int_0^1 C(t) dF(t)$ as the expected utility $E[U(T)]$:

$$U\left(\int_0^1 C(t) dF(t)\right) = \int_0^1 u(t) dF(t) \quad (12.2.14)$$

This is an extension that preserves the ordering of the trivial lotteries, of course. Moreover the definition is consistent with the remaining 4 von Neumann - Morgenstern axioms:

Axiom 2: The preference ordering of the set of all lotteries is transitive, and is an extension of the preference ordering of the set of trivial lotteries.

Axiom 3: For any non-equivalent lotteries A, B and for any $\alpha, \beta \in [0, 1]$:

$$(1 - \alpha)A + \alpha B \sim (1 - \beta)A + \beta B \Rightarrow \alpha = \beta \quad (12.2.15)$$

Axiom 4: For any lotteries A, B, C and for any $\alpha \in [0, 1]$:

$$A \sim B \Rightarrow (1 - \alpha)A + \alpha C \sim (1 - \alpha)B + \alpha C \quad (12.2.16)$$

Axiom 5: For any lotteries $A < B$ and for any $\alpha \in [0, 1]$:

$$A < (1 - \alpha)A + \alpha B < B \quad (12.2.17)$$

Axioms 3, 4 and 5 can hardly cause severe objections if Axiom 2 is accepted. It is trivial that these axioms are all satisfied for the ordering relation $<$ induced in the set of lotteries between the trivial lotteries by the utility definition (12.2.14). We will show that any other imposed extension of the ordering of the trivial lotteries will be in conflict with the axioms if the utility function $u(t)$ is bounded, that is, if $u(0) = \min u(t)$ and $u(1) = \max u(t)$ corresponding to the least preferred trivial lottery $C(0)$ and the most preferred trivial lottery $C(1)$, respectively.

By Axiom 1 we have that there is a probability $p(t)$ such that $C(t) \sim C(0)[1 - p(t)] + C(1)p(t)$ and by use of Axiom 4 we then have for any lottery (12.2.3) that

$$\begin{aligned} \int_0^1 C(t) dF(t) &\sim \int_0^1 \{C(0)[1 - p(t)] + C(1)p(t)\} dF(t) = \\ &\left(1 - \int_0^1 p(t) dF(t)\right)C(0) + \left(\int_0^1 p(t) dF(t)\right)C(1) \end{aligned} \quad (12.2.18)$$

Thus there are probabilities α and β such that

$$\int_0^1 C(t) dF(t) \sim (1 - \alpha)C(0) + \alpha C(1) \quad (12.2.19)$$

$$\int_0^1 C(t) dG(t) \sim (1 - \beta)C(0) + \beta C(1) \quad (12.2.20)$$

Assume that $\alpha\hat{E} \leq \beta$. Then we have by Axiom 4 that

$$\begin{aligned} \int_0^1 C(t) dF(t) &\sim \left(1 - \frac{\alpha}{\beta}\right)C(0) + \frac{\alpha}{\beta} \left((1 - \beta)C(0) + \beta C(1)\right) \sim \\ &\left(1 - \frac{\alpha}{\beta}\right)C(0) + \frac{\alpha}{\beta} \int_0^1 C(t) dG(t) \end{aligned} \quad (12.2.21)$$

which by Axiom 5 shows that the relation

$$\int_0^1 C(t) dF(t) < \int_0^1 C(t) dG(t) \quad (12.2.22)$$

is valid between the two lotteries defined by (12.2.18) and (12.2.20). Axiom 3 ensures that if the two lotteries are equivalent then the value of the integrals on both sides of (12.2.22) are equal after replacing $C(t)$ by $u(t)$. Obviously the ordering (12.2.22) is that obtained from the utility function (12.2.14). Thus any other ordering is in conflict with the axioms.

The axioms are originally formulated for a finite set of trivial lotteries implying that $u(t)$ is bounded. However, for the applications it is inconvenient to work only with a finite set of trivial lotteries. When the set of trivial lotteries is infinite it is not sufficient to restrict the utility function $u(t)$ for the trivial lotteries to be bounded, that is, we need to include the possibility that $u(t) \rightarrow -\infty$ as $t \downarrow 0$ and/or $u(t) \rightarrow \infty$ as $t \uparrow 1$. The extension is simply made by adopting a sixth axiom that states that the ordering in the set of lotteries for which the expected utility exists for each lottery L is induced by the utility function $U(L)$ defined by (12.2.14). Thus the extended axioms of von Neumann and Morgenstern lead to the decision rule that *the optimal decision is the one that selects the realizable lottery that has the largest utility provided the maximum exists within the set of realizable lotteries*.

The realizable lotteries are those lotteries that in the given practical situation can be run by an action. The set \mathcal{L} of lotteries between finitely many consequences from \mathcal{C} can naturally contain lotteries that do not correspond to a possible action. For example, this is the case when among the possible actions there is no action that for sure can be foreseen to lead to a given consequence. The lotteries in $\mathcal{C} \subset \mathcal{L}$ are then not realizable by any possible action.

It is emphasized that it is an implication of the *definition* of the utility function concept that it is the expected value of the utility that is the scalar indicator of the preference ordering. Thus it does not make logical sense to consider other parameters as ordering scalars such as fractile values in the lower tail of the probability distribution of the utility value. The utility values follow automatically from the Axioms 2 to 5 on the basis of the decision maker's ordering of \mathcal{C} by the use of equivalent lotteries as stated in Axiom 1. In practice it is usually the utility values corresponding to the consequences that are specified by the decision maker. He or she must thereafter per

definition accept the probabilities obtained from (12.2.13) in all the equivalent lotteries between any two consequences. A following correction of these probabilities may then conversely lead to a correction of the utility values as specified by (12.2.12).

The most frequent decision situation in practice is that where the consequences are claimed to be measurable on a monetary scale as gains or losses. Let us assume that each consequence $C \in \mathcal{C}$ has a monetary gain $g(C)$ (negative for loss) as the only effect of the consequence C . Then, of course, the decision maker will order C by the use of the gain function g . However, it is not necessarily given that the decision maker will identify the utility function $u(C)$ with $g(C)$. If we define $u(C) \equiv g(C)$, the expected utility equals the expected gain and the decision rule therefore maximizes the expected gain. If the chosen lottery is run several times with mutually independent repetitions of the lottery, the average gain per lottery will approach the expected gain with probability 1. In such a situation the adopted decision rule is clearly rational. Any other rule will in the long run lead to a smaller gain.

On the other hand, once or some few times in a lifetime the decision maker can be in a situation where he or she is about to do an action that realizes a lottery of great importance for him or her. The decision maker may then have a tendency to prefer the safe for the unsafe (gamblers the opposite, perhaps). This means that the lottery probability of the preferred consequence should be larger than the value obtained when $u(C) \equiv g(C)$ is used as utility function.

It is often claimed that several consequences of an engineering activity are of such a nature that they are not measurable on a numerical scale. It may be consequences that are about esthetical qualities or consequences that imply ethical problems as for example about setting the value of human life or evaluation of qualities of Nature and the importance of ecological mechanisms.

However, if decisions should not be made just at random but be well considered, it is necessary implicitly or explicitly to introduce a transitive preference ordering in the set of realizable lotteries even though this ordering need not be complete such as implied by the axioms of von Neumann and Morgenstern (a realizable lottery can have preference before all other realizable lotteries without the need that these are ordered relative to each other). By the accept of von Neumann's and Morgenstern's decision axiomatics also the existence of a scalar utility function is accepted with values that can be mapped on a monetary scale. The units of such a scale are often denoted as socio-economic units. By the lottery equivalences in Axiom 1 the socio-economic values can be made commensurable with monetary values. Of course, these equivalence evaluations can very well come out such that the resulting expected socio-economic value of a lottery does not increase proportionally with the expected monetary value of the lottery. Typically this will be the case for the previously mentioned prudent decision maker. In a lottery with small amounts of money he or she will possibly not hesitate with respect to the use of the monetary value evaluation. For larger amounts of money at stake the consequence of loss relative to the sure consequence can be much more serious for the future of the decision maker than the advantage he or she can get by a gain relative to the safe consequence. As an implication of this the utility value of the safe consequence is shifted to a larger value than the expected gain.

12.3 Optimal reliability

The discussion of the problem about the choice of the reliability level of a structure can conveniently be supported on the following often considered simplified decision theoretical model.

The anticipated capital investment in a structure under design is obviously a function $c(p)$ of the required failure probability p . This function can be assumed to be decreasing. Assume that the loss of the structure by a failure will imply an investment equal to $c(p) + d$ where d is the direct damage cost of the failure event (compensations for losses, clearing, etc.) measured in monetary units. For each value of p we thus have a lottery between two consequences, namely a consequence with the utility $-c(p)$ corresponding to the event of no failure, and a consequence with the utility $-2c(p) - d$ corresponding to the event of failure. These two consequences refer to a specific period of time. In order not to complicate the discussion with considerations on capitalizations (interest rate considerations) that require an extension of the model to keep account of the point in time at which the failure possibly occurs, the reference period is taken to be short like 1 year, say. The total cost (the utility with opposite sign) then is

$$c(p)\mathbf{1}_{\text{no failure}} + [c(p) + d]\mathbf{1}_{\text{failure}} \quad (12.3.1)$$

and it has the expected value

$$c(p)(1 - p) + [c(p) + d]p = c(p) + dp \quad (12.3.2)$$

Following von Neumann's and Morgenstern's decision rule we should among these infinitely many lotteries between two consequences choose the lottery for which the expected total cost is smallest. By differentiation of (12.3.2) we get the condition

$$c'(p) + d = 0 \quad (12.3.3)$$

for the determination of the optimal failure probability, that is,

$$d = -c'(p) \quad (12.3.4)$$

from which d is directly obtained as a function of p or from which p can be determined as a function of d .

Example 12.2 The variation of the capital investment within the relevant interval of small failure probabilities p can in most cases be approximated sufficiently accurately by a function of p which is linear in the generalized reliability index β :

$$c(p) - c(p_0) = a(\beta - \beta_0) \quad (12.3.5)$$

where a is the increase of cost per unit increase of β , and β_0 is a suitable representative reliability index (e.g., $\beta_0 = 4.76$ corresponding to the probability $p_0 = \Phi(-\beta_0) \approx 10^{-6}$). The equation (12.3.4) then becomes

$$\frac{d}{a} = \frac{d\beta}{d\beta} = \sqrt{2\pi} e^{\beta^2/2} = \begin{cases} 2.3 \times 10^2 & \text{for } \beta = 3 \\ 0.75 \times 10^4 & \text{for } \beta = 4 \\ 0.67 \times 10^6 & \text{for } \beta = 5 \end{cases} \quad (12.3.6)$$

Therefore, to get optimal reliabilities of the size required in present codes the direct damage costs must be several orders of magnitude larger than the investment $c(p)$.

For given d and for values of β that are relevant in structural reliability we thus find from (12.3.6) that the optimal generalized reliability index is approximately

$$\beta_{\text{opt}} \approx \sqrt{2 \log \left(\frac{d}{a\sqrt{2\pi}} \right)} \quad (12.3.7)$$

For an optimal value of β equal to 4.5, a change of the ratio d/a by a factor of 10 will only imply a change of the optimal value of β by about 10%. \square

Let us assume that engineering practice for the choice of target reliability in structural design develops in the direction of determination of the optimal reliability according to the decision-theoretical principles. Then the engineering profession must formulate regulating codes for certain utility value assessments that ensure a generally acceptable and authoritatively approved preference ordering of the consequences of any building activity. Codes for utility value specifications should in an initial phase be calibrated to such values that the code by and large leads to the target reliability levels approved by the superior authority and pointed out by this authority on the basis of the existing codes. As shown by the calculation in Example 12.2 this calibration will lead to very large values of the direct failure costs d . Often d will be orders of magnitude larger than the compensations ordinarily paid out by the insurance companies. This finding that the values of d are so large can perhaps be seen as a consequence of the natural aversion of the engineering profession against experiencing failures. Such an aversion is partly due to a fear of losing prestige and goodwill in the society but it may also be seen as an ethical attitude that commands the engineering activity to be practiced such that it will cause no harm to human health and life.

If the optimality postulate stated by the superior authority is accepted, that is, if it is taken for granted that the reliability levels defined implicitly for certain structure type classes by a current authorized code is optimal, it turns out that the damage cost d do not vary proportionally to realistic monetary compensation values. Thus the damage cost d is a socio-economic value.

Besides specifying critical utility values in suitable units that can be transformed into monetary units, a decision theoretical code just like a probabilistic code with specified target reliability levels should standardize a set of probability distribution types for the input variables. The necessity of the code standardization principle also for a decision theory based code is illustrated by the following example.

Example 12.3 Both engineers mentioned in Example 7.2 assume that the cost of the cable including its installation is kR where k is a constant. Upon failure the same cost applies for the replacement. On top of this there is a direct cost d of the failure. In part this cost includes an intangible cost of loss of human lives measured in socio-economic units. Thus the expected total cost is

$$kRP(S \leq R) + (kR + d)P(S > R) = kR + P(S > R)d \quad (12.3.8)$$

which for the normal distribution model becomes

$$kE[S](1 + \beta_N V) + \Phi(-\beta_N)d \quad (12.3.9)$$

By setting the derivative with respect to β_N to zero it follows that between the direct cost $d = d_N$ of failure and the optimal value of β_N there is the relation

$$\frac{d_N}{a} = \frac{1}{\varphi(\beta_N)} = \sqrt{2\pi} \exp(\beta_N^2/2) \tag{12.3.10}$$

in which $a = kE[S]V$ and β_0 is defined as in (12.3.5). This relation is the same as (12.3.6) (for

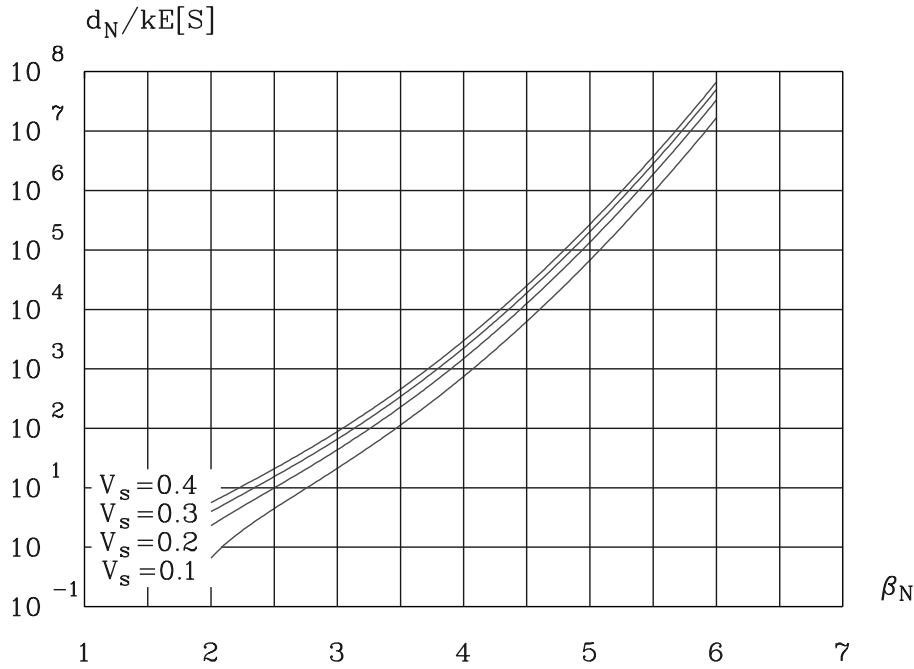

Figure 12.1: The intangible cost d_N as function of the optimal reliability index β_N corresponding to the normal model.

$\beta = \beta_N$). Figure 12.1 shows $d_N/kE[S]$ as function of β_N for $\beta_0 = 0$ and various values of V . For the lognormal model the expected total cost becomes

$$\frac{kE[S] \exp[\beta_{LN} \sqrt{\log(1 + V^2)}]}{\sqrt{1 + V^2}} + \Phi(-\beta_{LN})d \tag{12.3.11}$$

for which the relation between the direct cost $d = d_{LN}$ and the optimal value of β_{LN} is

$$\frac{d_{LN}}{kE[S]} = \frac{\exp[\beta_{LN} \sqrt{\log(1 + V^2)}]}{\sqrt{1 + V^2}} \frac{1}{\varphi(\beta_{LN})} \sqrt{\log(1 + V^2)} = (1 + \beta_N V) \frac{\sqrt{\log(1 + V^2)}}{\varphi(\beta_{LN})} \tag{12.3.12}$$

using that $R_N = R_{LN}$, see (7.1.14). Thus we have the ratio

$$\frac{d_{LN}}{d_N} = \frac{1}{V} (1 + \beta_N V) \sqrt{\log(1 + V^2)} \exp[(\beta_{LN}^2 - \beta_N^2)/2] \tag{12.3.13}$$

in which (7.2.15) should be substituted for β_{LN} . This ratio is shown in Fig. 12.2 as function of β_N for various values of $V = V_S$.

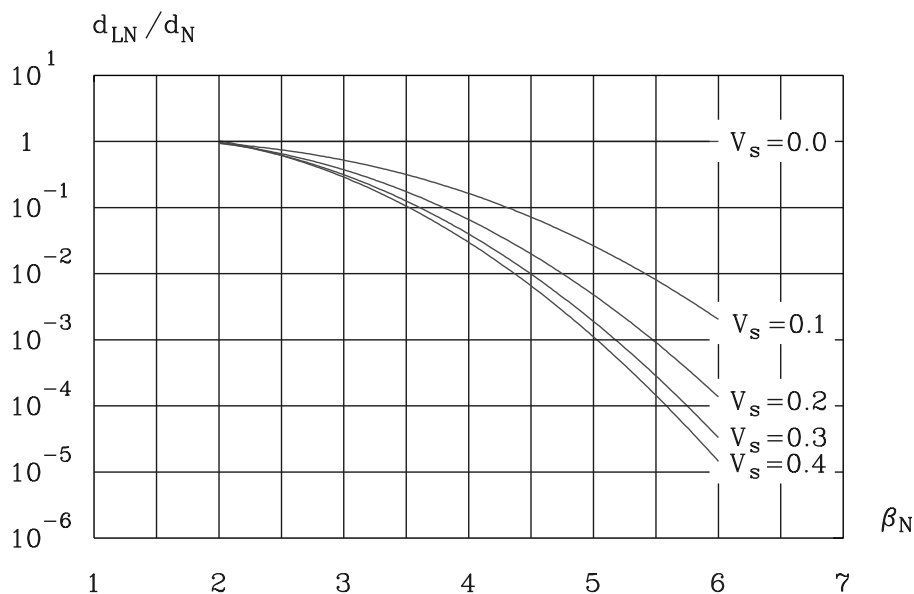

Figure 12.2: The ratio of the equivalent intangible costs d_{LN} and d_N for the lognormal and the normal model, respectively, as function of the optimal reliability index β_N .

It is seen from Figs. 7.1 and 12.2 that to obtain the same optimal resistance R in the two models, the two engineers must apply quite different values (d_N and d_{LN}) of the direct failure cost d as well as quite different values (β_N and β_{LN}) of the reliability index β . This is the so-called “tail sensitivity problem” that obviously calls for a code standardization of the distribution type. On the other hand, it follows from Fig. 12.1 that the optimal value of β_N is not very sensitive to the choice of d_N . \square

12.4 Uncertain gain and utility functions

Construction activities imply direct monetary costs that at the state of the design decision making are not known with certainty. The costs are assessed by considering present price levels and perhaps by setting up prognosis models for the future economical environments of the project. Such considerations may lead to an assessment of a probability distribution of the actual monetary costs. With respect to monetary costs the realization of the project is thus considered as a draw from this distribution, that is, as a run of a lottery. This lottery is a component of a composite lottery in the set of lotteries \mathcal{L} of relevance for the actual decision problem. When taking the expected value of the utility of the composite lottery the monetary cost component will contribute merely with its expected value. Thus it follows that the future monetary costs need only be assessed up to the expected value. Observed average costs over several similar projects together with relevant prognosis considerations are therefore sufficient guides for the assessment of the monetary costs that should be used as inputs to the decision model.

The decision maker may be uncertain about his or hers preferences. This is reflected in un-

certainty about the choice of the utility function $u(C)$. In the particular case where the utility is identified with the gain, the problem has been clarified above. If the considered consequence C is not directly measurable on a monetary scale implying that a socio-economic utility value must be assigned to C , the problem may be dealt with in the same way. The uncertainty in the mind of the decision maker is expressed by his or hers assessment of a probability distribution of utility values rather than by a choice of a unique utility value. Thus the consequence C is with respect to utility dissolved into a set of socio-economic values. A lottery between these values is included as a component of the relevant composite lottery. The lottery probabilities are given by the assessed probability distribution. As for the monetary gain it follows that it is sufficient to use the expected value in the utility distribution as the input utility value of the consequence C in the decision model.

We can conclude from the considerations in this section that *in presence of uncertain gain or utility functions it is only the expected gain or utility function which is relevant for the final decision problem.*

Example 12.4 Consider the variability of the reliability index of the tubular joints obtained by partial safety factor design as reported in Example 12.1. This variability can be transformed into variability of the direct damage cost d by considering the ratio $d/(a\sqrt{2\pi})$ obtained from (12.3.6) as a random variable $D/(a\sqrt{2\pi})$. Thus the partial safety factor code gives uncertain information about the direct failure cost. If all the variability is taken as an expression of the societal uncertainty of the assessment of the value of d (or better expressed, perhaps, the uncertainty left over to the code committee that faces the problem of calibrating a probabilistic code to an existing partial safety factor code), it follows from the decision theory that d should be put to its expectation $E[D]$. Since

$$\frac{E[D]}{a\sqrt{2\pi}} \simeq \frac{1}{\sigma} \int_{-\infty}^{\infty} e^{-x^2/2} \varphi\left(\frac{x-\mu}{\sigma}\right) dx = \frac{1}{\sqrt{1-\sigma^2}} \exp\left[\frac{\mu^2}{2(1-\sigma^2)}\right] \quad (12.4.1)$$

in which $\mu = 4.40$ and $\sigma = 0.30$, the optimal reliability index according to (12.3.7) becomes

$$\beta_{\text{opt}} \simeq \sqrt{\frac{\mu^2}{1-\sigma^2} - \log(1-\sigma^2)} \simeq 4.62 \quad (12.4.2)$$

This value of β_{opt} is seen to be larger than the expectation $E[\beta] = 4.40$ while $\beta_{\text{class}} = 4.21$ is smaller than the expectation, see (12.1.5). It is also seen that $E[D]$ increases with σ and that $E[D] \rightarrow \infty$ ($\beta_{\text{opt}} \rightarrow \infty$) as $\sigma \rightarrow 1$. Of course, these specific conclusions can only be claimed to be valid for the example considered here, where the uncertainty distribution of β is normal.

More refined analyses may be made in specific realistic examples of practice. For example, the coefficient a in (12.3.5) can be a random variable when considering the variation over structures.

The calibration procedure leading to (12.4.2) is based on the idea that the partial safety factor format gives an optimal design for a representative joint. The uncertainty about which joint is representative is simply interpreted as uncertainty of the damage cost D .

As for the partial safety factor format with a single value set of factors it is in this procedure assumed that the failure consequence is the same for all joints (structures) designed according to the code. The uncertainty is assumed only to be about the evaluation of the socio-economic cost of the failure. On a more detailed level of modeling it is reasonable to include the possibility of having variation of the real failure consequence over the set of joints of the offshore structure. Let

us imagine that the set of joints by event analysis is divided into subsets within each of which the consequence of failure is the same. This classification into subsets is completely independent of the code format applied to design the joints. Therefore the probability distribution of the reliability index is the same for all the subsets and the same as the distribution for the total set of all joints. However, the relation between the reliability index and the damage cost can no longer be based on the optimality postulate which would lead directly to an inconsistency because it implies that the expected damage cost is the same for all subsets. A simple model for obtaining a variation of the expected damage cost over the set of subsets is as follows.

Write the damage cost as $D = CD'$ where C and D' are mutually independent random variables such that $E[C] = 1$. The factor C represents the variation over the set of subsets while D' represents the uncertain socio-economic cost of the failure in the average over all subsets. Assume that the consequence analysis leads to an assessment of the coefficient of variation V_C of C . Then it is possible to obtain the same total variation of D as induced by the partial safety factor code if the equation

$$(1 + V_C^2)(1 + V_{D'}^2) = 1 + V_D^2 \quad (12.4.3)$$

for the coefficient of variation of $D = CD'$ can be satisfied for some value $V_{D'} > 0$. This is the case only if $V_C \leq V_D$. Referring to (12.4.1) we have

$$\frac{E[D^2]}{a^2 2\pi} \approx \frac{1}{\sigma} \int_{-\infty}^{\infty} e^{x^2} \varphi\left(\frac{x-\mu}{\sigma}\right) dx = \frac{1}{\sqrt{1-2\sigma^2}} \exp\left[\frac{\mu^2}{1-2\sigma^2}\right] \quad (12.4.4)$$

so that

$$1 + V_D^2 = \frac{E[D^2]}{E[D]^2} = \frac{1 - \sigma^2}{\sqrt{1 - 2\sigma^2}} \exp\left[\frac{\mu^2 \sigma^2}{(1 - \sigma^2)(1 - 2\sigma^2)}\right] \rightarrow \exp[\mu^2 \sigma^2 (1 + 3\sigma^2)] \quad (12.4.5)$$

asymptotically as $\sigma \rightarrow 0$. With σ' being the standard deviation of D' we get $1 + V_{D'}^2$ from (12.4.5) by substituting $\sigma = \sigma'$. We may now use the optimality postulate on CD' for C given. Thus (12.4.1) gives $E[CD' | C] = CE[D']$ and (12.3.7) gives by substituting $d = CE[D']$ that

$$\beta_{\text{opt}|C} \approx \sqrt{\frac{\mu^2}{1 - \sigma'^2} - \log(1 - \sigma'^2) + 2 \log C} \quad (12.4.6)$$

For $\mu = 4.40$, $\sigma = 0.3$ we find $1 + V_D^2 = 10.381$ ($V_D \approx 3.06$). If $V_C = 2$, say, we get $1 + V_{D'}^2 = 2.076$ ($V_{D'} = 1.04$). From (12.4.5) we next find $\sigma' \approx 0.185$ so that (12.4.6) gives

$$\beta_{\text{opt}|C} \approx 4.48(1 + 0.05 \log C) = \begin{cases} 4.32 & \text{for } C = 0.5 \\ 4.63 & \text{for } C = 2 \end{cases} \quad (12.4.7)$$

This line of reasoning shows that it is possible to make a reasonable calibration of a probabilistic code to a given partial safety factor code even under consideration of consequence differentiation. The probabilistic code may specify some few safety classes that together cover what in the partial safety factor code is considered to be only one safety class. Such a classification with associated reliability levels determined according to (12.4.6) can be taken as a possible solution to

the problem of reliability level choice stated in the text at the end of the tubular joint illustrative example, Example 12.1. The reliability levels of the classes are consistent with the dispersion induced by the partial safety factor code and therefore these reliability levels should all be acceptable by the superior authority. Moreover, the reason for giving accept is made stronger by improving rationality through exercising an explicit professional consequence evaluation. \square

12.5 Influence from uncertain determination of the lottery probabilities

In engineering decision considerations the lottery probabilities $\alpha_1, \alpha_2, \dots, \alpha_n$ of getting the consequences C_1, C_2, \dots, C_n , respectively, are usually determined by evaluations supported on data and calculations that are based on idealized models. These models combine geometric properties and physical laws and assumptions in an anticipatory way (that is imaginative predicting). There is a considerable uncertainty in this evaluation be it based on limited sets of data or on anticipatory models.

The total uncertainty can formally be represented by a suitable joint probability distribution for the set of relevant input parameters with unknown values. This distribution expresses a measure of the knowledge about the input parameters and it is determined on the basis of those substudies that are parts of the relevant risk analysis. In principle the joint uncertainty distribution of the parameters lead to an uncertainty distribution of the lottery probabilities $\alpha_1, \alpha_2, \dots, \alpha_n$. Thus the values of $\alpha_1, \alpha_2, \dots, \alpha_n$ are not known and therefore it cannot be said that the lottery $L(\alpha_1, \alpha_2, \dots, \alpha_n)$ is run corresponding to these probabilities when performing an action following from a decision. The lottery $L(\alpha_1, \alpha_2, \dots, \alpha_n)$ is simply not realizable (it cannot be run with certainty). On the other hand, the lottery $L(\alpha_1, \alpha_2, \dots, \alpha_n)$ gets the role as a consequence in a realizable lottery between all lotteries between the consequences C_1, C_2, \dots, C_n . The lottery probabilities in this composite lottery are determined by the joint uncertainty distribution of the lottery probabilities $\alpha_1, \alpha_2, \dots, \alpha_n$. By the action, the values $\alpha_1, \alpha_2, \dots, \alpha_n$ are drawn from the uncertainty distribution upon which the drawn lottery is run. It follows from the rules of the probability theory that this two step lottery cannot be distinguished on its outcomes from the one step lottery that as lottery probabilities has the mean values in the uncertainty distribution of the lottery probabilities. This last lottery is therefore equivalent with the composite lottery and it is therefore the only realizable lottery between the considered consequences. From this it follows that the uncertainty distribution on the lottery probabilities $\alpha_1, \alpha_2, \dots, \alpha_n$ is without relevance for the decision maker except for the mean values.

Usually the lottery probabilities are nonlinear functions of the input parameters. Therefore it is a mistake to conclude that the degree of uncertainty of the input parameters has no influence because the nonlinearities imply that the mean values of the lottery probabilities are not functions solely of the mean values of the input parameters but in principle of their entire joint probability distribution.

If we revisit the lottery in Section 12.3 it looks as if the consequences in this lottery are functions of the lottery probabilities. Such a dependence will naturally not lead to the aforementioned simple composite lottery situation. However, the correct formulation of (12.3.2) is

$$c(E[P]) + [c(E[P]) + d]P \quad (12.5.1)$$

where P is the Bayesian random variable that corresponds to the unknown parameter p . The investment c , realized by an action, can only vary with respect to the realizable lotteries because solely a realizable lottery is chosen by the action.

Example 12.5 Suppose that a building is supported on two columns that both can be subject to a failure event. Assume that the two failure events for given distribution parameters are mutually independent and have the same probability p . Let $\mathbf{1}_I$ and $\mathbf{1}_{II}$ be the indicator variables for failure of first and second column, respectively. Then we have a lottery between the consequences of three possible events with the probabilities

$$P(\text{no failure}) = E[(1 - \mathbf{1}_I)(1 - \mathbf{1}_{II})] = (1 - p)^2 \quad (12.5.2)$$

$$P(\text{failure of one column}) = E[\mathbf{1}_I(1 - \mathbf{1}_{II}) + (1 - \mathbf{1}_I)\mathbf{1}_{II}] = 2p(1 - p) \quad (12.5.3)$$

$$P(\text{failure}) = E[\mathbf{1}_I\mathbf{1}_{II}] = p^2 \quad (12.5.4)$$

The relevant lottery becomes

$$E[(1 - P)^2]K_1 + E[2P(1 - P)]K_2 + E[P^2]K_3 \quad (12.5.5)$$

where P is the Bayesian random variable that corresponds to p .

Let the direct loss by failure be d and assume that the loss is the same whether a single column fails or both columns fail. The expected loss by failure then becomes

$$E[2P(1 - P) + P^2]d = (2E[P] - E[P^2])d \quad (12.5.6)$$

which is seen for fixed $E[P]$ to decrease with increasing variance $\text{Var}[P] = E[P^2] - E[P]^2$. This does not imply that it cannot pay to gather more information with the purpose of decreasing the uncertainty in the determination of the probability p . Consideration of new information will change both $E[P]$ and $\text{Var}[P]$. If p is small the change will usually be in the advantageous direction. \square

12.6 The engineering problem about the choice of utilities facing the phenomenon of risk aversion

It is important for the implementation of a rational decision strategy that it has been established who is the decision maker. Moreover it is important that the interests of this decision maker can be formulated. Here it will be assumed that a company (which in particular can be the public society) is the decision maker and that the interest of the company is to run an economically optimal activity. It is assumed that this activity is run under due consideration of relevant sources of malfunctioning that may generate losses. Moreover, it is assumed that the company has to act in a political climate that influences the size of the losses.

The majority of the relevant utilities in structural engineering are of the monetary type. These utilities can be chosen without fundamental difficulties. The difficulties appear when choosing utilities that concern aversion against certain intangible phenomena. Such aversions seem to play

an essential role in public political decision processes where the debate is going on pro et contra the construction of big technical plants.

An example of risk aversion is the attitude that the loss of a large number of human lives by one single accident is evaluated as considerably worse than the loss of the same number of human lives by as many separated accidents. It has been experienced that the public (the politicians) and the news media react heavily on the big single accident and are almost indifferent to the many small accidents. These accidents are just an everyday occurrence. The problem is to which extent the company by its choice of utilities should consider this and similar phenomena. Here the company should make clear to itself to which degree its interests are harmed by the reaction of the public. There can be a real loss after a large accident if the politicians require that costly safety increasing measures should be introduced before continued operation of the structure can be allowed. This means that the loss by such a big accident must be increased not due to an increased value of several simultaneous losses of human lives but due to the increased material costs of the re-establishing of the structure and/or the increased operation costs. If the company chooses to take this aversion phenomenon as a possibility of loss beyond proportionality, this extra loss should therefore not be quantified solely in dependence of lost human lives by a single accident but rather by the monetary losses appearing after the accident due to the possible political actions. Specific examples of such risk aversion modeling are given in Section 12.11.

For accidents that threaten the natural environments the same aversion phenomena appears. After an accident with environmental damages that at the time of the accident are declared to be “irremediable” one should expect political interference.

The problem about risk aversion is difficult, of course. In spite of this it is a reflection of rationality and order in own line of thinking (self consistency with respect to preferences) to confront oneself directly with this problem and to make a choice. Quite commonly criteria setting authorities of the company (or the public) “sweep the problem under the carpet” by stipulating limit values of the probabilities of the considered adverse events. These limit values are set with value variation that in some mysterious way is believed to be a rational mirroring of the phenomenon of risk aversion. The limit probabilities are even thought of as limit values of “absolute probabilities”, whatever that means. If such absolute probabilities are not just metaphysical quantities but are believed to contain interpretable empirical evidence, they are in practical decision situations determined with considerable uncertainty. One could ask about the rationality in the decision making when very uncertain guesses on absolute probability values are compared with arbitrarily chosen limit values.

These critical remarks should not be taken as a claim that the result of a set of decision analyses relevant to the company cannot be summarized by a set of operational rules that contain limit values of probabilities or other characteristic quantities. However, such limit values can be chosen by use of the superior decision strategy and they can be considered as comparison quantities for probabilities obtained in a well specified model with well specified input. By this interpretation “absolute” probabilities are replaced by “operational” probabilities in a normative modeling system.

12.7 Codified constraints

For certain types of decisions involving ethical values and/or general protection of societal standards of quality of life and property including protection of Nature there exists in many communities a general public consensus of setting codified upper or lower limits directly or indirectly to some types of more or less intangible socio-economic costs. With respect to structural design decisions such constraints on the decisions are in many countries code specified in terms of values of safety factors to be applied together with more or less standard structural analysis models and standard models of strengths of materials.

Constraints can also be set from the public on the set of realizable lotteries by requiring that the lottery probabilities corresponding to certain adverse events be kept below specified limits. Such probability limits should be calibrated to fit with a superior standard of safety. They will depend on the specific probabilistic model used in the analysis. Thus it is not sufficient to require that the probability of failure, say, is less than a given number without specifying to which formal probabilistic model this limit probability refers, that is, to which code of practice it belongs. Likewise the calibrated values of the intangible costs of failure are sensitive with respect to the considered probability distributions. On the other hand, for a given probabilistic model the optimal structural dimensions of highly reliable structures are not very sensitive with respect to changes of the intangible costs. An illustration of these sensitivity properties is given for the very simple structure in Example 12.3.

12.8 Multi-criteria decision analysis

Even though the principles of the decision theory of von Neumann and Morgenstern are easy to appreciate, they may not be easy to implement in practical decision situations where support in codes of practice cannot be found. In particular the decision maker may face problems about choosing the utility function $u(C)$ when each consequence $C \in \mathcal{C}$ is made up of $m > 1$ component consequences $\kappa_1, \dots, \kappa_n$ that are not directly commensurable on a monetary scale or which may interact with respect to preference. Let the consequences in \mathcal{C} be

$$\begin{aligned} C_1 &= (\kappa_{11}, \kappa_{12}, \dots, \kappa_{1m}) \\ &\vdots \\ C_n &= (\kappa_{n1}, \kappa_{n2}, \dots, \kappa_{nm}) \end{aligned} \tag{12.8.1}$$

Then there may be obvious preference orderings in each of the components but the ordering will usually differ from component to component. In other words, each component defines a decision criterion but two or more of these m criteria may be mutually inconsistent. Assume that utilities $u(\kappa_{1j}), \dots, u(\kappa_{nj})$ are assigned by the decision maker to each of the component consequences such that the utilities are commensurable between the consequences $\kappa_{1j}, \dots, \kappa_{nj}$ for each $j = 1, \dots, m$. The index j on the utility function reflects that the utility value scale may differ with respect to j . For each j the utilities are said to be commensurable if $\alpha_1 u(\kappa_{1j}) + \dots + \alpha_n u(\kappa_{nj})$ can be accepted as the expected utility of the lottery between the consequences $\kappa_{1j}, \dots, \kappa_{nj}$ for any choice of the lottery probabilities $\alpha_1, \dots, \alpha_n$.

In some decision problems it makes sense to define the utility function $u(C)$ solely on the basis of the component utility functions u_1, \dots, u_m . In fact, if the decision maker claims that he or she is able to define the component utilities on the same socio-economic scale, that is, to choose utility unit transformation factors w_1, \dots, w_m such that $w_1 u_1, \dots, w_m u_m$ become utility functions with common value scale, and that the component consequences do not interact with respect to preference, then it can be shown that the utility of the composite consequence $C = (\kappa_1, \dots, \kappa_m)$ for any $C \in \mathcal{C}$ should be defined as

$$u(C) = w_1 u_1(\kappa_1) + \dots + w_m u_m(\kappa_m) \quad (12.8.2)$$

except for an arbitrary additive constant. (Formally the definition of no interaction of the component consequences with respect to preference is as follows: Let $L' = \alpha_1 C_1 + \dots + \alpha_n C_n$ and $L'' = \beta_1 C_1 + \dots + \beta_n C_n$ be any two different lotteries defined such that the component lotteries $L'_j = \alpha_1 \kappa_{1j} + \dots + \alpha_n \kappa_{nj}$ and $L''_j = \beta_1 \kappa_{1j} + \dots + \beta_n \kappa_{nj}$, $j = 1, \dots, m$, are run independently of each other. Then the component consequences are said not to interact with respect to preference if the statement $L'_j \sim L''_j$ for all $j = 1, \dots, m$ implies that $L' \sim L''$).

If the component consequences interact with respect to preference, it is in general not possible to define the utility $u(C)$ in terms of the component utilities $u_1(\kappa_1), \dots, u_m(\kappa_m)$ alone. As an example consider a redundant structure where the failure or no failure of element number j are the two relevant consequences for element j . For the structure the composite consequences are the vectors of consequences related to the elements of the structure. It is obvious that the component consequences in this example interact with respect to preference. In any such case of preference interaction the decision maker must assign utilities directly to the composite consequences.

Example 12.6 The formulas of this example are formulated solely for the purpose of illustration. They are not based on real evidence.

Consider the design of a chimney with a filter device for limiting the amount of pollutant released to the atmosphere. For a given chimney height it is assumed that there is a given probability distribution of the concentration of the pollutant at a given point in the vicinity of the chimney for one unit of pollutant released from the chimney. The mean concentration is assumed to decrease inversely proportional to the square of the chimney height H . Moreover, it is assumed that the mean concentration C is directly proportional to the released amount A per time unit of pollutant within the relevant range of the release. Thus we assume that $C = kA/H^2$, where k is some constant. The release rate of pollutant depends on the filter capacity. The filter capacity is expressed as the reduction factor F by which the pollutant release rate P is reduced by passing the smoke through the filter, i.e. $A = PF$.

The construction and maintenance cost of the chimney is assumed to be proportional to H^2 and of the filter to be a constant c_0 plus an amount proportional to $(1/F - 1)^2$. It has in principle been decided by the authorities that the owner of the chimney must pay a duty per time unit to the state proportional to A , for A larger than some threshold value. However, it has not been possible for the politicians to get unique scientifically based advices from environmentalists about what the threshold value should be. Instead it has been decided to conglomerate the advices in terms of a "fragility curve" expressing the probability that the release rate A is sufficiently harmful to justify the full duty proportional to A . According to the same principles a duty must be paid to the local community per time unit for causing the concentration C of pollutant.

Upon capitalization to present value the total cost of the chimney project becomes

$$c_0 + c_1 \left(\frac{1}{F} - 1 \right)^2 + c_2 H^2 + c_3 P F G_A(PF) + c_4 k \frac{PF}{H^2} G_C \left(k \frac{PF}{H^2} \right) \quad (12.8.3)$$

which should be less than or equal to the capitalized net value of the production, of course. The functions $G_A(x)$ and $G_C(x)$ are the fragility functions, c_1, c_2 are constant cost factors, while c_3, c_4 are constant duty factors including the effect of capitalization. $G_A(x), G_C(x), c_3, c_4$ are assumed to be specified by the authorities presumably such that $G_A(x)$ and $G_C(x)$ both are continuously increasing from $G_A(0) = G_C(0) = 0$ to 1 for suitably large x . The best choice of H and F for the owner is then the choice that minimizes the total cost (12.8.3).

As an alternative to a system of duties the authorities can institute a mandatory code of practice in which G_A, G_C, c_3, c_4 are specified. In the expression (12.8.3) the variables k, P , and F may be generalized to be random variables or even to be more general probability theoretical concepts. In any case, the minimum of the expected value of the total cost leads to the rational decision. \square

12.9 Influence of radical errors*

Let us look a little more critical on the assumptions on which (12.3.1) is based. We have defined the indicator variable $\mathbf{I}_{\text{failure}}$ within a probabilistic failure model that includes ubiquitous internal random fluctuations of the values of the relevant input variables and also the uncertainties of the distribution parameters of these input variables. Also the model uncertainty is included both what concerns the distributional types and the limit state. However, this probabilistic model does not reflect the possibility of radical errors occurring at the design stage, in the construction process or in service [human errors or “acts of God” (that is, natural disasters, war events or similar events)]. Such events are usually not classified as always present sources of uncertainty associated to the given project. They are rare cases (hopefully) of radical misfits between the realized structural design and the theoretical model used in the reliability analysis.

In order to take care of the possible occurrence of radical errors we can extend the probabilistic model and assign the expectation

$$E[\mathbf{I}_{\text{failure}}] = P(\text{failure and no radical errors}) + P(\text{failure and radical errors}) \quad (12.9.1)$$

The first term on the right hand side of (12.9.1) can be written as the product of the conditional probability

$$p_{\text{theory}} = P(\text{failure} \mid \text{no radical errors}) \quad (12.9.2)$$

(the “theoretical” failure probability) and the probability

$$1 - p_{\text{error}} = P(\text{no radical errors}) \quad (12.9.3)$$

The second term on the right hand side of (12.9.1) can be written as the sum

$$P(\text{failure and radical errors}) = \sum_i P(\text{failure} \mid \text{radical error } i) p_{\text{error } i} \quad (12.9.4)$$

where $p_{\text{error } i}$ is the probability of the occurrence of error radical error i . Here it is assumed that the set of different possible radical errors are countable. Several together occurring errors are considered as a combined radical error (a union of radical error events). In this way the numerated radical error events become disjoint so that

$$p_{\text{error}} = \sum_i p_{\text{error } i} \quad (12.9.5)$$

is the probability of the occurrence of radical errors. The conditional probability

$$h_i(p_{\text{theory}}) = P(\text{failure} \mid \text{radical error } i) \quad (12.9.6)$$

is calculated by use of a modification of the probabilistic model corresponding to the altered structure that results as a consequence of the occurrence of the radical error i . The dimensions of the altered structure are functions of the target value of the critical failure probability p_{theory} , of course. Therefore this is also the case for $P(\text{failure} \mid \text{radical error } i)$. All in all the failure probability (12.9.1) can be written as

$$E[\mathbf{I}_{\text{failure}}] = p_{\text{theory}}(1 - p_{\text{error}}) + \sum_i h_i(p_{\text{theory}}) p_{\text{error } i} \quad (12.9.7)$$

Using this result the expected cost (12.3.2) is modified to

$$c(p) + [p(1 - p_{\text{error}}) + \sum_i h_i(p) p_{\text{error } i}] d \quad (12.9.8)$$

where $p = p_{\text{theory}}$. In this expression the capital investment $c(p)$ should ideally be defined more carefully in dependence of whether the structure is realized without radical errors or with the one or the other radical error. However, this is of minor importance because $p_{\text{error}} \ll 1$, $c(p) \ll d$ and the error capital investment for the structure with radical error and the structure without radical errors is almost the same.

Usually it can be assumed that p_{error} is independent of or only slightly dependent on p_{theory} . Essentially there is only a variation of p_{error} over the set of error alternative layouts of the structure because dimension variations for a given layout are expected only to have a modest influence on the potential proneness to radical error occurrences. For a given layout of the structure it therefore makes sense to seek a minimum for the expected cost (12.9.8) under fixed values of $p_{\text{error } 1}, p_{\text{error } 2}, \dots$. By differentiation of (12.9.8) with respect to p we then get the condition

$$c'(p) + [1 - p_{\text{error}} + \sum_i h'_i(p) p_{\text{error } i}] d = 0 \quad (12.9.9)$$

which by use of (12.9.5) reduces to

$$d = \frac{-c'(p)}{1 + \sum_i [h'_i(p) - 1] p_{\text{error } i}} \quad (12.9.10)$$

Without further modeling of the structural consequences of the considered radical errors it is difficult to see whether the sum term can be neglected, and thereby obtain that the result (12.3.4)

can be considered to represent optimal design independent of whether or not radical errors can occur.

Assume that numerator in (12.9.10) decreases with p . Then, for fixed d , the solution of (12.9.10) with respect to p increases relative to that of (12.3.4) [i.e. $d = -c'(p)$] if the sum term is negative. Since it is reasonable to assume that $h'_i(p) > 0$, the sum term is bounded from below by $-p_{\text{error}}$ which in absolute value is assumed to be negligible as compared to 1. If the sum term is positive, p as determined by (12.3.4) is a lower value for p as determined by solving (12.9.10).

Among the different alternative layouts the optimal layout is that for which (12.9.8) becomes smallest after substitution of the value of p valid for each layout.

Finally it should be noted that there are exceptions from the rule that p_{error} can be modeled to be independent of p_{theory} . An example is the radical design error of forgetting to investigate the reliability of a column with respect to stability failure. If p_{theory} is very small the column possibly becomes so voluminous that it is considered as a pillar, which hardly directly reminds the engineer about the possibility of a stability failure. The probability p_{error} of forgetting the stability problem should presumably be assessed as being large in this situation. If p_{theory} is suitably large the column becomes so slender that the need for a stability analysis becomes obvious. Therefore the stability analysis is less prone to be forgotten. Thus it seems reasonable to model p_{error} as a decreasing function of p_{theory} .

12.10 Utility loss considerations

Utility and limit state

From a decision theoretical point of view the occurrence of undesirable structural behavior of a certain type is associated with a loss of utility. The utility is conveniently defined as a scalar function of the state of the structure, that is, of the basic input variables of the structural analysis model. However, a design decision does rarely imply a specific choice of the values of the basic variables. Rather a design decision implies a choice of a lottery between an infinity of states.

The concept of limit state as introduced in Chapter 2 is obviously applicable for such types of undesirable behavior that reasonably can be represented by defining a certain subset of the space of basic variables to be the set of undesirable values of the basic variables. Such a description is applicable in situations where the utility of the structural state is anticipated to have a steep decrease from a constant value in one part of the space of basic variables to a lower constant value in another part of the space of basic variables. The decrease is anticipated to be so steep relative to the dispersion of the random vector of basic variables that the utility function can be idealized as a two-valued function. The set of points at which the jump in value takes place can then be considered as a limit state.

In case the space of the basic variables is the n -dimensional real space \mathbf{R}^n , the expected utility of the state of the structure is in general given by the integral

$$E[u(\mathbf{X})] = \int_{\mathbf{R}^n} u(\mathbf{x}) f_{\mathbf{X}}(\mathbf{x}) dx_1 \cdots dx_n \quad (12.10.1)$$

of the utility function $u(\mathbf{x})$ with respect to the probability density $f_{\mathbf{X}}(\mathbf{x})$ of the set of basic variables. For a limit state situation with utility loss C_f (i.e., C_f can be interpreted as the socio-economic cost of failure), (12.10.1) reduces to

$$E[u(\mathbf{X})] = E[-C_f \mathbf{1}_{\mathbf{X} \in \mathcal{F}}] = -C_f \int_{\mathcal{F}} f_{\mathbf{X}}(\mathbf{x}) dx_1 \cdots dx_n = -C_f p_f \quad (12.10.2)$$

except for an arbitrary additive constant. Here \mathcal{F} is the set of undesirable behavior (the failure set) and $p_f = P(\mathbf{X} \in \mathcal{F})$ is the probability of the event $\mathbf{X} \in \mathcal{F}$, that is, p_f is the failure probability.

The anticipation of the steepness of the utility function can in some situations of undesirable phenomena be less clear than for a collapse problem, say. In spite of this, codes often specify formal limit states for such situations. It should be made clear, however, that such sharp definitions of undesirable behavior can be in conflict with rational decision making. The point is that rational decision making requires that alternative choices of the probability distribution of \mathbf{X} (e.g. alternative choices of the mean of \mathbf{X}) are evaluated against each other by comparing the sum of the direct construction costs and the expected utility loss for the different possible choices. This means that if $u(\mathbf{x})$ in (12.10.1) is approximated by a two-valued function then the approximation should be reasonable not just for a specific choice of $f_{\mathbf{X}}(\mathbf{x})$ but for all relevant alternative choices. This requirement makes it sometimes difficult to justify the introduction of a physically non-existing formal limit state. Code given formal limit states of this “non-physical” type ideally originate from calibrations to results of more realistic models. Often they are only applicable within narrow domains of value variations of the relevant structural parameters.

Another point is that the position of a physically existing (up to a reasonable degree of idealization, of course) limit state in \mathbb{R}^n can be uncertain. This means that the two-valued utility function is uncertain. The uncertainty of the position of the limit state has the effect that it is not known for sure whether a point in the space \mathbb{R}^n of basic variables corresponds to undesirable behavior or not. Given that $\mathbf{X} = \mathbf{x}$ there is a probability $P(\mathbf{x} \in \mathcal{F})$ which is not necessarily either 0 or 1, Section 3.4. Thus there is a conditional expected utility increment equal to

$$u(\mathbf{x}) = -C_f P(\mathbf{x} \in \mathcal{F}) \quad (12.10.3)$$

The total expected utility increment is given by (12.10.1) with (12.10.3) substituted.

Time variant loss of utility

The time dimension is taken into account by considering the vector of basic variables to be a function $\mathbf{x}(t)$ of time t . Then the utility concept is generalized to be associated to the entire ordered set of structural states defined by $\mathbf{x}(t)$, that is, the utility is a functional $\mathcal{U}[\mathbf{x}(t)]$. Often the time developing structural states are only specified up to a random vector process $\mathbf{X}(t)$, Chapter 15. In this case the expected utility is the average utility over the weighted ensemble of all possible sample functions of $\mathbf{X}(t)$. This general concept of expected utility is rather abstract but it can in special important modeling situations be made easy to appreciate.

One important example is related to the phenomenon of fatigue. Cyclic stress variations cause increasing damage which may be considered as the same as increasing loss of utility just as consumption of capital is a loss of utility. In the simplest models of the fatigue damage accumulation

process such as the Palmgren-Miner rule the utility loss is a weighted sum of the number of stress cycles where the weights depend on the stress range of the corresponding cycles. Even for rather simple random process descriptions of the stress variation it can be a quite complicated problem to define the single cycles and to determine the expected utility loss.

Much simpler examples are considered in the following. These examples are related to the concept of limit state.

The direct generalization of the time invariant limit-state model is obtained by considering the random time T until first passage of $\mathbf{X}(t)$ into the set \mathcal{F} of undesirable behavior and assuming that the utility loss C_f is obtained at time T while no further loss associated with the considered structure can occur later than T . For example, the structure may cease to exist at time T . By discounting back to present time the loss becomes the random variable

$$C_f e^{-\gamma T} \quad (12.10.4)$$

where γ is the discount rate. Thus the expected utility loss becomes

$$E[\mathcal{W}[\mathbf{X}(t)]] = -C_f \int_0^{\infty} e^{-\gamma t} f_T(t) dt \quad (12.10.5)$$

in which $f_T(t)$ is the probability density function for the first passage time T of $\mathbf{X}(t)$ into \mathcal{F} . In the particular case where $\mathbf{X}(t)$ is a constant vector (the time invariant case) the first passage time density becomes the defect density

$$f_T(t) = p_f \delta(t) \quad (12.10.6)$$

where $\delta(t)$ is Dirac's delta function, and where the defect is the probability $1 - p_f$ of never passing the limit state. Thus (12.10.5) reduces to (12.10.2). A reduction to (12.10.2) is also obtained when the utility loss by passing the limit state is defined as

$$C_f e^{-\gamma T} \mathbf{1}_{T \in [0, L]} \quad (12.10.7)$$

in which L can be interpreted as the design life time of the structure. Then (12.10.2) is obtained from (12.10.5) for $\gamma L \rightarrow 0$.

Utility loss by sequential excursions beyond the limit state

Another relevant example of a utility definition in the time variant case can be built directly on a model that specifies a partitioning of the space of the instantaneous values of the basic variables into a set of less desirable values and the complementary set of desirable values. This partitioning can be fixed in time or it can be time variant. Each passage into the set of less desirable behavior is assumed to be associated with a utility loss C . If the successive passage times are $T_1, T_2, \dots, T_n, \dots$ and the discount rate is γ , the total utility loss discounted to present value becomes

$$C \sum_{n=1}^{\infty} e^{-\gamma T_n} \quad (12.10.8)$$

The expected utility loss depends on the joint distribution of the passage times $T_1, T_2, \dots, T_n, \dots$. A simple special example is obtained when $T_1, T_2, \dots, T_n, \dots$ are points of a homogeneous Poisson process of intensity λ , Chapter 15. Then except for the factor C the expected utility loss becomes

$$E \left[\sum_{n=1}^{\infty} e^{-\gamma T_n} \right] = \sum_{n=1}^{\infty} \left[\int_0^{\infty} e^{-\gamma t} \lambda e^{-\lambda t} dt \right]^n = \sum_{n=1}^{\infty} \left[\frac{\lambda}{\lambda + \gamma} \right]^n = \frac{\lambda}{\gamma} \quad (12.10.9)$$

showing that the expected utility loss is directly proportional to λ , that is, to the mean number of passages per time unit into the set of less desirable behavior.

If only the behavior in the design life time L has importance, the utility loss corresponding to (12.10.8) is defined as

$$C \sum_{n=1}^{\infty} e^{-\gamma T_n} \mathbf{1}_{T_n \in [0, L]} \quad (12.10.10)$$

For the homogeneous Poisson process case the expected utility loss then becomes, except for the factor C ,

$$E \left[\sum_{n=1}^{\infty} e^{-\gamma T_n} \mathbf{1}_{T_n \in [0, L]} \right] = E \left[E \left[\mathbf{1}_{N>0} \sum_{n=1}^N e^{-\gamma T_n} \middle| N \right] \right] = E \left[N \frac{1}{L} \int_0^L e^{-\gamma t} dt \right] = \lambda L \frac{1 - e^{-\gamma L}}{\gamma L} \quad (12.10.11)$$

which approaches $E[N] = \lambda L$ asymptotically as $L \rightarrow 0$. In this calculation N is the random number of passages into the set of less desirable values during the time L . Moreover, it is used that T_1, \dots, T_N for any given value of N is a sample from the uniform distribution on the interval $[0, L]$. The utility loss is seen to be directly proportional to the mean number $E[N]$ of passages into the set of less desirable values during the design life time L .

Sometimes the duration of the excursion of $\mathbf{X}(t)$ into the set of less desirable behavior can be important for the loss of utility. Except for a constant factor C an example of a utility loss of this type is

$$\sum_{n=1}^{\infty} \int_{T_n}^{S_n} e^{-\gamma t} dt = \sum_{n=1}^{\infty} e^{-\gamma T_n} \frac{1 - e^{-\gamma(S_n - T_n)}}{\gamma} \quad (12.10.12)$$

in which S_n is the time of first passage back to the set of desirable behavior after the time T_n of the n th passage into the set of less desirable behavior. Assuming that $T_1, T_2, \dots, T_n, \dots$ are points of a homogeneous Poisson process of intensity λ , and that $S_n - T_n$ is independent of T_1, \dots, T_n with a distribution which is independent of n , it follows from (12.10.9) that the expected utility loss becomes

$$C \frac{\lambda}{\gamma} \frac{1 - E[e^{-\gamma(S_n - T_n)}]}{\gamma} \rightarrow C \frac{\lambda}{\gamma} E[S_n - T_n] \quad (12.10.13)$$

asymptotically as $\gamma \rightarrow 0$. Thus the utility loss is approximately directly proportional to the mean total excursion time per time unit given that the value of the discount rate is sufficiently small.

This utility definition does not distinguish between a situation with many short excursions or few long excursions. It is simply the total time that matters. An example where the utility loss

increases with the duration of uninterrupted excursion periods is obtained by defining the utility loss to be proportional to

$$\sum_{n=1}^{\infty} \int_{T_n}^{S_n} (t - T_n) e^{-\gamma t} dt = \sum_{n=1}^{\infty} e^{-\gamma T_n} \frac{1 - e^{-\gamma(S_n - T_n)} - \gamma(S_n - T_n)e^{-\gamma(S_n - T_n)}}{\gamma^2} \quad (12.10.14)$$

which with the same assumptions as above gives the expected utility loss

$$C \frac{\lambda}{\gamma} E[(S_n - T_n)^2] \quad (12.10.15)$$

asymptotically as $\gamma \rightarrow 0$. Thus the utility loss is directly proportional to the mean number of excursions per time unit and directly proportional to the second moment of the duration of the uninterrupted excursion.

Discount rate and design life

In purely economical cost evaluations the discount rate γ may have a real monetary meaning of being the actual interest rate corrected with respect to the inflation rate. In the present state of the financial market it seems not to be unreasonable to assess γ to be of the order of 0.05 to 0.10 per year. For the design life time $L = 100$ years, say, and for values of $\gamma > 0.046$ the factor $(1 - \exp[-\gamma L]) / \gamma L$ in (12.10.11) deviates less than 1% from $1/\gamma L$. Thus (12.10.11) is quite close to the result λ/γ as given by (12.10.9). This shows that the choice of the value of the design life time L has negligible influence on the structural design if L is sufficiently large and if it is given that socio-economic evaluations have no relevance in the considered situation. However, for intangible values it may become relevant to apply discount rates very close to zero. It can be argued that if the consequence of failure can be loss of human lives, then there is an ethical problem about the choice of the value of γ . For example, if $\gamma = 0.05$ it means that the present value of a human life lost 50 years from present is less than 10% of the present value of that life. The problem has been avoided formally in practice by setting $\gamma = 0$ and instead introducing the concept of design life time. Thus the right side of (12.10.11) becomes λL , which asymptotically for $\lambda L \rightarrow 0$ is the same as the probability of failure during the design life time L . This is seen from computing the expectation of (12.10.7) for $\gamma = 0$.

The use of the concept of a finite design life time can make the analysis unnecessarily complicated. It is often mathematically much simpler to let the design life time be infinite and accept a suitably small non-zero discount rate for the intangible costs. In fact, setting $\gamma = 1/L$, the expectation in (12.10.9) becomes λL . Thus the acceptance of $L = 100$ years, say, implies that a discount rate of $\gamma = 0.01$ per year is accepted together with $L = \infty$.

In conclusion, the discount rate can be taken as a formal design criterion regulation parameter with the same effect in practice as the formal design lifetime has. This conclusion does not exclude the possibility of working simultaneously with several formal and realistic discount rate values within the same structural decision problem.

Structural performance criteria

Generally the construction costs and the expected utility loss by passing into the set of less desirable values vary in opposite directions when the structural dimensions are varied. Assuming that the utility loss can be compared with the construction costs on a common scale the rational choice of the structural dimensions should correspond to the minimum of the sum of the construction costs and the utility loss.

The previous examples illustrate that the expected utility loss corresponding to a limit state model of the structural behavior is the product of a constant factor C and a quantity which is a sort of an intensity measure for the occurrence of the undesirable behavior. In principle the choice of the factor C is a matter for the decision maker. The optimization procedure will then lead to the target value of the intensity measure. In order to avoid a conflict between a profit seeking decision maker and the interests of the public of having high quality structures and of protecting lives and environment it has become practice to set up code requirements that imply upper bounds on some types of these intensity measures of undesirable behavior. This leads to definitions of structural performance criteria. They have the effect that there in specific design situations can be a lower bound on the choice of the constant C .

It is concluded from the previous discussion that structural performance criteria can be formulated on the basis of utility loss considerations and optimization studies. Calibration of values to existing practice can ensure public acceptance.

12.11 Examples of risk aversion modeling*

Referring to Section 12.6 on the risk aversion problem it is assumed as an example that a political intervention after an accident occurs only if some scalar measure δ related to the structural state of damage is larger than some critical number δ_c . Exceeding of this level is anticipated to imply a larger number of losses of human lives at the same accident. Moreover it is assumed that political intervention only happens the first time an exceeding at the level δ_c occurs. The point process of action pulses is taken to be a homogeneous Poisson process, and the corresponding scalar measures $\delta_1, \delta_2, \dots$ are outcomes of mutually independent and identically distributed random variables $\Delta_1, \Delta_2, \dots$, respectively, Fig. 12.3. The common probability density function is $f_\Delta(\delta)$.

If the political intervention leads to an increased control of the actions on the structure the effect is that the intensity λ of the Poisson process of action pulses is changed to a lower value λ' after an exceeding of the critical level δ_c has occurred. The value to be assigned to λ' is assessed on the basis of a study of the system for increased control. The expected cost of failure then becomes (see (12.11.7) - (12.11.12) for derivation of the first term)

$$\frac{\lambda}{\gamma} \left(\frac{\gamma + \lambda' p}{\gamma + \lambda p} E[C(\Delta)] + \frac{ap}{\gamma + \lambda p} \right) \quad (12.11.1)$$

in which the last term is the expected aversion cost in which a is the yearly cost of action control, γ is the discount rate,

$$p = P(\Delta > \delta_c) = \int_{\delta_c}^{\infty} f_\Delta(\delta) d\delta \quad (12.11.2)$$

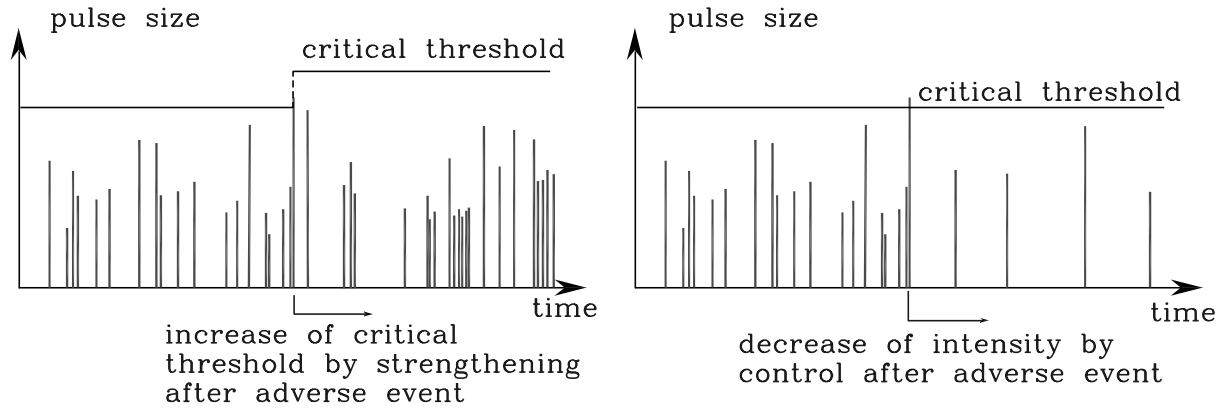

Figure 12.3: Illustration of two different policies to meet risk aversion consequences after the occurrence of an adverse event.

and $C(\delta)$ is the utility loss associated with a state measured by δ . The expected aversion cost is derived as follows. The political intervention happens at the first point occurring in the thinned Poisson process of action pulses obtained by using the thinning probability p . The random time S until political intervention is therefore exponentially distributed with mean $1/(p\lambda)$. The cost discounted to time S of the political intervention happening at time S becomes

$$\int_0^\infty a e^{-\gamma t} dt = \frac{a}{\gamma} \tag{12.11.3}$$

Thus the expected aversion cost is

$$E \left[\frac{a}{\gamma} e^{-\gamma S} \right] = \frac{a}{\gamma} \int_0^\infty e^{-(\gamma+\lambda p)t} dt = \frac{a}{\gamma} \frac{\lambda p}{\gamma + \lambda p} \tag{12.11.4}$$

If alternatively the political intervention leads to an increase of the resistance of the structure against the considered action pulses, the density function $f_\Delta(\delta)$ should be changed accordingly to $f_{\Delta'}(\delta)$ after the critical event has occurred. The expected cost of failure then becomes (see (12.11.13) - (12.11.17) for derivation of the first term)

$$\frac{\lambda}{\gamma} \left[\frac{\gamma}{\gamma + \lambda p} \left(E[C(\Delta)] + \frac{\lambda p}{\gamma} E[C(\Delta')] \right) + \frac{ap}{\gamma + \lambda p} \right] \tag{12.11.5}$$

in which p is given by (12.11.2) and a/γ is now the cost of the structural strengthening to be made at time S .

The uncertainty in the choice of δ_c and the control or strengthening cost a/γ (which very well can depend on δ_c) can be taken into account by modeling (δ_c, a) as an outcome of the random pair (Δ_c, A) . Then the expected aversion cost becomes

$$E \left[\frac{A}{\gamma} E[e^{-\gamma S} | \Delta_c] \right] = \frac{1}{\gamma} \int_0^\infty \int_0^\infty \frac{ap(\delta_c)}{\gamma + \lambda p(\delta_c)} f_{\Delta_c, A}(\delta_c, a) d\delta_c da \tag{12.11.6}$$

The first terms in (12.11.1) and (12.11.5) are treated similarly.

In practical applications it will ordinarily be so that $\lambda p/\gamma \ll 1$. In that case the expected cost of failure given either by (12.11.1) or by (12.11.5) simplifies to the same expression:

$$\frac{\lambda}{\gamma} \left(E[C(\Delta)] + \frac{ap}{\gamma} \right) \quad (12.11.7)$$

Thus the risk aversion is rationally taken care of simply by increasing the expected cost $E[C(\Delta)]$ of a single failure event by the expected cost ap/γ of political intervention given that the failure event occurs. Note that the value of life and limb is included in $C(\Delta)$ and not in a/γ .

Derivation

In order to derive the expression (12.11.1) let N be the random number of action pulses until the critical event occurs. Then

$$P(N = n) = p(1 - p)^{n-1}, \quad n = 1, 2, \dots \quad (12.11.8)$$

Let X_i be the cost at the i th action pulse. For given $N = n$ the total cost is

$$\sum_{i=1}^n X_i e^{-\gamma T_i} + e^{-\gamma T_n} \sum_{i=1}^{\infty} X_{n+i} e^{-\gamma S_i} \quad (12.11.9)$$

where T_1, \dots, T_n are the first n time points in the Poisson process of intensity λ while S_1, S_2, \dots are the time points of the Poisson process of intensity λ' . It is noted that T_n and S_i are mutually independent for all i .

The density of T_i (or S_i) is the Erlang density (special gamma density):

$$\frac{\lambda^i}{(i-1)!} t^{i-1} e^{-\lambda t}, \quad t \in \mathbb{R}_+ \quad (12.11.10)$$

with $\lambda = \lambda'$ for S_i . Then

$$E[e^{-\gamma T_i}] = \frac{\lambda^i}{(i-1)!} \int_0^{\infty} e^{-(\gamma+\lambda)t} t^{i-1} dt = \left(\frac{\lambda}{\gamma+\lambda} \right)^i \quad (12.11.11)$$

With $E[X_i] = \mu$ for all i (and X_i independent of T_i) the expectation of (12.11.9) then becomes

$$\begin{aligned} \mu \left[\sum_{i=1}^n \left(\frac{\lambda}{\gamma+\lambda} \right)^i + \left(\frac{\lambda}{\gamma+\lambda} \right)^n \sum_{i=1}^{\infty} \left(\frac{\lambda'}{\gamma+\lambda'} \right)^i \right] &= \mu \left[\frac{\lambda}{\gamma} \left\{ 1 - \left(\frac{\lambda}{\gamma+\lambda} \right)^n \right\} + \frac{\lambda'}{\gamma} \left(\frac{\lambda}{\gamma+\lambda} \right)^n \right] \\ &= \mu \left[\frac{\lambda}{\gamma} + \frac{\lambda' - \lambda}{\gamma} \left(\frac{\lambda}{\gamma+\lambda} \right)^n \right] \end{aligned} \quad (12.11.12)$$

After multiplication of (12.11.12) by (12.11.8) and summing over all values of n we finally get

$$\mu \left(\frac{\lambda}{\gamma} - \frac{\lambda - \lambda'}{\gamma} \frac{\lambda p}{\gamma + \lambda p} \right) = \mu \frac{\lambda \gamma + \lambda' p}{\gamma \gamma + \lambda p} \quad (12.11.13)$$

which is the first term in (12.11.1) with $\mu = E[C(\Delta)]$.

For the alternative political intervention, (12.11.9) is changed to

$$\sum_{i=1}^n X_i e^{-\gamma T_i} + e^{-\gamma T_i} \sum_{i=1}^{\infty} Y_{n+i} e^{-\gamma S_i} \quad (12.11.14)$$

with $\lambda = \lambda'$ and $E[X_i] = \mu$, $E[Y_{n+i}] = \mu'$ corresponding to the change of the density function of the scalar measure Δ to that of Δ' . Thus (12.11.12) is changed to

$$\mu \frac{\lambda}{\gamma} \left\{ 1 - \left(\frac{\lambda}{\gamma + \lambda} \right)^n \right\} + \mu' \frac{\lambda}{\gamma} \left(\frac{\lambda}{\gamma + \lambda} \right)^n = \mu \frac{\lambda}{\gamma} - (\mu - \mu') \frac{\lambda}{\gamma} \left(\frac{\lambda}{\gamma + \lambda} \right)^n \quad (12.11.15)$$

Unconditioning with respect to N then gives

$$\mu \frac{\lambda}{\gamma} - (\mu - \mu') \frac{\lambda}{\gamma} \frac{\lambda p}{\gamma + \lambda p} \quad (12.11.16)$$

which is the first term in (12.11.5) with

$$\mu = E[C(\Delta)] = \int_0^{\infty} C(\delta) f_{\Delta}(\delta) d\delta \quad (12.11.17)$$

$$\mu' = E[C(\Delta')] = \int_0^{\infty} C(\delta) f_{\Delta'}(\delta) d\delta \quad (12.11.18)$$

Bibliography

[12.1] Bjerager, P. (1985) Offshore Konstruktioner 5947, Notat 8, Pålidelighedsanalyse. Teaching note in Danish. Department of Structural Engineering, Technical University of Denmark.

[12.2] Von Neumann and Morgenstern (1943) *Theory of Games and Economical Behavior*. Princeton University Press, Princeton.

Chapter 13

RELIABILITY OF EXISTING STRUCTURES

13.1 Information types for an existing structure

This chapter deals with the philosophy and the solution methods that are relevant for the evaluation of the reliability of an existing structure. The theory is focused on reliability updating when new information becomes available.

Evaluation of an existing structure becomes actual when damages are observed, when the use of the structure is planned to be changed, when deviations from the project descriptions are observed, when the life time is up to extension beyond what is planned, when inspection schedules are planned to be revised, etc.

When compared to the information available in the design phase, new information may come from reception control of concrete, certificates for steel and reinforcement, measurements of actual geometry, collection of load data, proof load testing, inspection and damage evaluation. This extra information is usually considered for the purpose of verifying that the structure to a reasonable degree is realized as prescribed, that is, the information is used for detecting possible mistakes that have occurred during the construction. Sometimes this verification reveals mistakes that concern the model assumptions or the calculations. In connection with this control of the calculational assumptions the information can be used for reliability updating. In this chapter we will solely look at updating and related decisions that involve possible actions that may change the existing structure (alternative actions: demolition, let the structure be unchanged, repair, strengthening, introduction of restrictions in the use of the structure).

The information can be divided in two main types:

1. *Sampling information* that updates the knowledge about distributional types with associated distributional parameters for the random input vector \mathbf{X} without conditioning on possible observed relations between the components of \mathbf{X} . This type of information has been treated in Chapter 11 and it will not be considered further.

2. *Relation information* saying that one or more known relations exist between the elements of \mathbf{X} . To explain what this concept is about the following division into two types is considered:

(a) One or more of the components of \mathbf{X} are realized such that the unknown outcome of \mathbf{X} is known to belong to a suitably characterized subset Ω of \mathbb{R}^n . This set may often be defined by use of a function $h(\mathbf{x})$ such that

$$\Omega = \{\mathbf{x} \in \mathbb{R}^n | h(\mathbf{x}) \leq 0\} \quad (13.1.1)$$

Usually the function $h(\mathbf{x})$ comes from an idealized model of the behavior of the structure. Therefore model uncertainty should be assigned to the definition of Ω in the same way as model uncertainty is assigned to the definition of a limit state. The model uncertainty can be included directly in the definition of $h(\mathbf{x})$ by use of suitable random parameters whose outcomes fix Ω . Thereby the set becomes a random set. In a more simple form the model uncertainty can be represented by a random correction to \mathbf{X} in the same way as the model uncertainty of an idealized limit state was represented in Section 3.4. In that case the set in (13.1.1) is a given set fixed before the registration of the information. If significant measuring uncertainty influences the determination of whether or not the event $\mathbf{X} \in \Omega$ has occurred, this measuring uncertainty similarly must be represented by a random correction of \mathbf{X} .

In certain applications it may also happen that Ω can possess internal randomness such that Ω in its nature becomes a random set. Examples are given in the following.

(b) One or more of the components of \mathbf{X} are realized such that the unknown outcome of \mathbf{X} has caused an effect that, except for model uncertainty, can be predicted uniquely by a theoretical model $\psi(\mathbf{x})$ for each realization $\mathbf{X} = \mathbf{x}$ and also be measured uniquely except for measuring uncertainty. It is assumed that the model uncertainty and the measuring uncertainty are both known from previous investigations or that these uncertainties can be evaluated by theoretical and experimental evaluations of the model and by repeated measurements of the considered effect, respectively.

The information obtained by the measurement of the effect then expresses that the unknown outcome of \mathbf{X} satisfies the relation

$$\psi(\mathbf{X}) = Z \quad (13.1.2)$$

in which Z is a random variable whose distribution is fixed by the measurement.

Example 13.1 A structural element has the carrying capacity R with respect to the load effect S . Failure occurs if and only if $R < S$. It is assumed in the design phase of the element that R and S are mutually independent logarithmic normal random variables such that $X_1 = \log R$ has parameters (μ_1, σ_1) and $X_2 = \log S$ has parameters (μ_2, σ_2) . Thus the reliability index becomes

$$\beta = \frac{\mu_1 - \mu_2}{\sqrt{\sigma_1^2 + \sigma_2^2}} \quad (13.1.3)$$

Assume that the structural element is subjected to a proof loading up to the value $S = s$ and that the element survives this load. This information says that the unknown outcome of $\mathbf{X} = (X_1, X_2)$ belongs to the set

$$\Omega = \{(x_1, x_2) \in \mathbb{R}^2 | x_1 > \log s\} \quad (13.1.4)$$

If s is fixed without significant uncertainty, it can be concluded that X_1 has the conditional distribution function

$$F_{X_1}(x|\mathbf{X} \in \Omega) = \Phi_\gamma\left(\frac{x - \mu_1}{\sigma_1}\right) \quad (13.1.5)$$

where

$$\gamma = \frac{\log s - \mu_1}{\sigma_1} \quad (13.1.6)$$

and $\Phi_\gamma(\cdot)$ is the lower truncated standardized normal distribution function with truncation point γ , see (10.3.8).

The conditional failure probability is then

$$P(R < S|\mathbf{X} \in \Omega) = \frac{1}{\sigma_2} \int_{-\infty}^{\infty} \Phi_\gamma\left(\frac{x - \mu_1}{\sigma_1}\right) \varphi\left(\frac{x - \mu_2}{\sigma_2}\right) dx \quad (13.1.7)$$

For the values $\sigma_1 = 0.2 (\approx V_R)$, $\sigma_2 = 0.5 (\approx V_S)$, $\mu_1 = 4\sqrt{0.29} = 2.154$, $\mu_2 = 0$, the unconditional reliability index (13.3.3) gets the value 4. The conditional reliability index corresponding to (13.3.7) is shown in Fig. 13.1. It is seen that the proof loading must be made at rather high levels relative to the strength distribution in order that an essential increase of the reliability-index value over the value of 4 is obtained. For example, only an increase of 5% (from 4 to 4.2) is obtained for $\gamma \approx -1.3$. This fractile value corresponds to about 10% probability of getting failure during the proof loading. \square

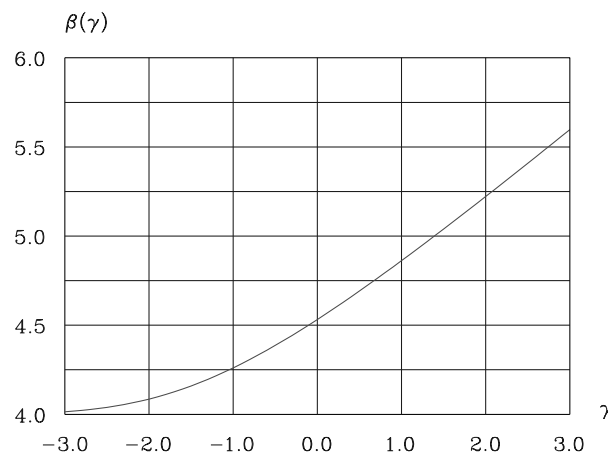

Figure 13.1: Conditional reliability index $\beta(\gamma)$ as a function of the proof load level γ .

Example 13.2 Let us assume that the structural element in Example 13.1 is subject not only to a single load effect S but to a sequence $S_1, S_2, \dots, S_m, \dots$ of mutually independent load effects that are identically distributed with logarithmic normal distribution. Moreover let us assume that erroneously it was taken as given at the design stage that the element would be subject to one and only one such load effect. The element is realized in a structure for which the total life time is

planned to be T . The load effects S_1, S_2, \dots have short duration and they occur in succession but randomly in time, implying that there is a random number $N(\tau)$ of them within a time interval of given duration τ .

It is assumed that $N(\tau)$ has a Poisson distribution with parameter $c\tau$ where c is a constant which can be interpreted as the mean value of the number of load effects per time unit. Thus we have the probability

$$P[N(\tau) = n] = \frac{(c\tau)^n}{n!} e^{-c\tau} \quad (13.1.8)$$

Given that $N(T) = n$, the maximal value of $\log S_1, \dots, \log S_n$ has the distribution function $\Phi[(x - \mu_2)/\sigma_2]^n$. The distribution function of

$$\log S = \max\{\log S_1, \dots, \log S_{N(T)}\} \quad (13.1.9)$$

can then by use of (13.1.8) be obtained as

$$F_{\log S}(x) = \sum_{n=0}^{\infty} \Phi\left(\frac{x - \mu_2}{\sigma_2}\right)^n \frac{(cT)^n}{n!} e^{-cT} = \exp\left[-cT\Phi\left(-\frac{x - \mu_2}{\sigma_2}\right)\right] \quad (13.1.10)$$

An elegant way to see this result is as follows: If only those points of the Poisson process of intensity c (see Chapter 15 for definition) for which $\log S_i > x$ are considered, then a so-called thinned Poisson process of intensity $cP[\log S_1 > x]$ is obtained. Obviously the event $\log S \leq x$ occurs if and only if there are no points from this thinned Poisson process during the time T . The right side of (13.1.10) is then directly obtained as the probability of this event (corresponding to setting $n = 0$ in (13.1.8)).

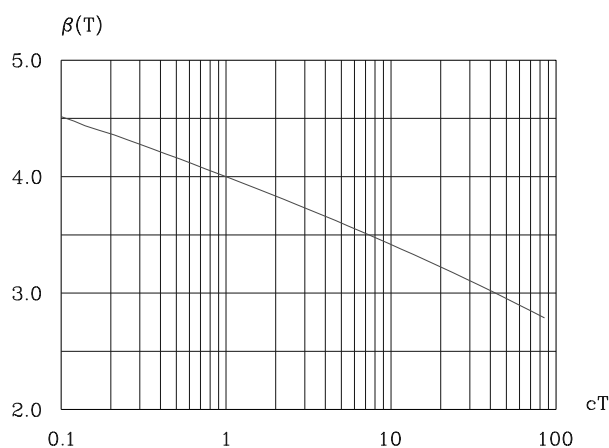

Figure 13.2: Reliability index for structural element with logarithmic normal strength as a function of the mean number cT of mutually independent identically distributed load effects within the time period T . The parameter c is the intensity of the occurrence of the load effects in time by a Poisson process.

For $cT = 1$ and for large x the distribution function (13.1.10) approximately equals $\Phi[(x - \mu_2)/\sigma_2]$. In particular, for $cT = 1$, the effect of the simplification used in the design phase is

therefore without importance. The correct reliability index is

$$\beta(T) = \Phi^{-1} \left[\int_{-\infty}^{\infty} \exp \left[-cT\Phi \left(-\frac{x - \mu_2}{\sigma_2} \right) \right] \phi \left(\frac{x - \mu_1}{\sigma_1} \right) \frac{dx}{\sigma_1} \right] \quad (13.1.11)$$

and it is shown in Fig. 13.2 as a function of cT for the parameter values considered in Example 13.1.

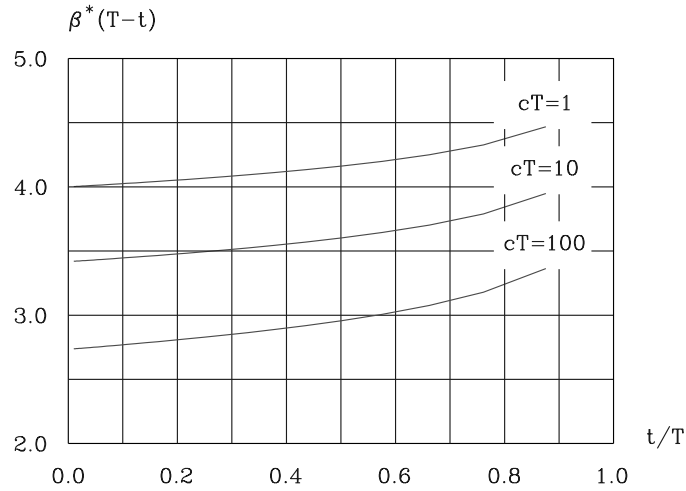

Figure 13.3: Updating of the reliability index in Fig. 13.2 on the basis of the information given by (13.1.12).

Due to a repair situation at time t after the time of start of the use of the structure it is discovered during the inspection of the old calculations that the load assumption is to the unsafe side since cT rather than being close to 1 is about 100. Therefore it is judged to be necessary to evaluate the reliability of the structural element with respect to failure in the remaining service period of duration $T - t$. This reliability evaluation uses the information that the structural element without failure has survived all occurring loads in the time interval of length t . Thus the resistance R satisfies the condition

$$R > \max\{S_1, \dots, S_{N(t)}\} \quad (13.1.12)$$

This is an example of relation information of the type $\mathbf{X} \in \Omega$, where Ω is a random set. The conditional failure probability becomes

$$1 - P(R > \max\{S_{N(t)+1}, \dots, S_{N(T)}\} | R > \max\{S_1, \dots, S_{N(t)}\}) = 1 - \frac{P(\max\{S_1, \dots, S_{N(T)}\} < R)}{P(\max\{S_1, \dots, S_{N(t)}\} < R)} = 1 - \frac{\Phi[\beta(T)]}{\Phi[\beta(t)]} \quad (13.1.13)$$

giving the updated reliability index

$$\beta^*(T - t) = \Phi^{-1} \left[\frac{\Phi[\beta(T)]}{\Phi[\beta(t)]} \right] \quad (13.1.14)$$

corresponding to the remaining life $T - t$. Fig. 13.3 shows $\beta^*(T - t)$ as a function of t/T for $cT = 1, 10, 100$. It is seen that the updating effect is modest unless t/T is large. \square

It is less easy to construct similarly simple examples of reliability updating by use of relation information of the type $\psi(\mathbf{X}) = Z$ (the type 2(b)) obtained by non-destructive measuring methods applied to an existing structure.

A realistic but fairly complicated example will be given later. It is considerably easier to give simple examples when the problem is about updating of the probability for exceeding a serviceability limit-state. A typical example is the use of a sample of measured deformations for given loads. These measuring results can be compared with results from theoretical models that contain input variables for stiffnesses of the structural parts and the supports. Another typical example is the use of a measurement of the lowest eigenfrequency of a mast. The calculated eigenfrequency depends on input variables that describe the distribution of the masses and the stiffnesses.

13.2 General system formulation for updating by use of relation information*

For the representation of relation information it is convenient to introduce the concept of event margin as an extension of the concept of safety margin. An event margin is defined by the random variable

$$H = h(\mathbf{X}, \mathbf{Z}) \quad (13.2.1)$$

where $h(\mathbf{x}, \mathbf{z})$ is identical to the function $h(\mathbf{x})$ in (13.1.1) when relation information of the type $\mathbf{X} \in \Omega(\mathbf{Z})$ is considered. The vector \mathbf{Z} is a random vector that governs the randomness of Ω in the sense that Ω is uniquely fixed when given the outcome of \mathbf{Z} .

If relation information of the type $\psi(\mathbf{X}) = Z$ is considered, the function $h(\mathbf{x}, z)$ is defined by

$$h(\mathbf{x}, z) = \psi(\mathbf{x}) - z \quad (13.2.2)$$

Thus the relation information is expressed by $H \leq 0$ for the type 2(a) and $H = 0$ for the type 2(b). In the following we will change the notation for (\mathbf{x}, z) and (\mathbf{X}, Z) to \mathbf{x} and \mathbf{X} , respectively. The function in (13.2.2) will be written as $h(\mathbf{x})$.

For relation information of the first type we then have the updated failure probability

$$P(M \leq 0 | H \leq 0) = \frac{P(M \leq 0, H \leq 0)}{P(H \leq 0)} \quad (13.2.3)$$

where M is the relevant safety margin.

The event $H \leq 0$ can be an intersection of several events $H_1 \leq 0, \dots, H_m \leq 0$ where H_1, \dots, H_m are the event margins corresponding to m different information contributions. The failure event $M \leq 0$ can be more or less complicatedly defined as the failure event of a series system of parallel systems or as a parallel system of series systems.

The numerator in (13.2.3) is seen to have the form as the probability of failure of a parallel system with two failure events $M \leq 0$ and $H \leq 0$. If the probability $P(H \leq 0)$ is small, both the

numerator and the denominator can usually be calculated with sufficient accuracy by use of (6.6.7) (single-point multiple FORM) or a corresponding formula based on SORM.

For relation information of the second type the updated failure probability is defined by

$$\begin{aligned} P(M \leq 0 | H = 0) &= \lim_{\theta \downarrow 0} P(M \leq 0 | -\theta < H \leq 0) \\ &= \lim_{\theta \downarrow 0} \frac{P(M \leq 0, H \leq 0) - P(M \leq 0, H \leq -\theta)}{P(H \leq 0) - P(H \leq -\theta)} = \left[\frac{\frac{\partial}{\partial \theta} P(M \leq 0, H + \theta \leq 0)}{\frac{\partial}{\partial \theta} P(H + \theta \leq 0)} \right]_{\theta=0} \end{aligned} \quad (13.2.4)$$

Remark 13.1 Conditional probabilities $P(B|A)$ with $P(A) = 0$ must be defined with particular care because the numerator and the denominator of the ratio $P(A \cap B)/P(A)$ are both zero.

For any descending sequence of sets $A_1 \supset A_2 \supset \dots \supset A_n \supset \dots$ with $P(A_i) \neq 0$ for all i and with the limit set

$$A = \bigcap_{n=1}^{\infty} A_n \quad (13.2.5)$$

we have a well-defined sequence of conditional probabilities

$$P(B|A_1), P(B|A_2), \dots, P(B|A_n), \dots \quad (13.2.6)$$

If this sequence is convergent, it is natural to define the conditional probability $P(B|A)$ as the limit of the sequence. However, by this procedure $P(B|A)$ is not uniquely defined since the limit depends of the chosen set sequence A_1, \dots, A_n, \dots , see below. Any definition of $P(B|A)$ is therefore associated to a carefully defined class of sets from which any chosen descending set sequence with A as limit set has the property that the corresponding sequence of conditional probabilities is defined and is convergent with a limit which is common to all such sequences chosen from the considered class of sets. The relevant definition for a given application of $P(B|A)$ is determined by those set sequences that have A as limit set and are relevant for the application.

The problem is illustrated in an elementary way by considering a pair (X, Y) of random variables with density function $f_{X,Y}(x, y)$ together with the pair $(X, Z) = (X, XY)$ for which the density function is

$$f_{X,Z}(x, z) = f_{X,Y}\left(x, \frac{z}{x}\right) \frac{1}{|x|} \quad (13.2.7)$$

(the mapping $(x, y) \curvearrowright (x, z) = (x, xy)$ has the Jacobi determinant $\partial(x, z)/\partial(x, y) = x$). Thus we have the conditional densities

$$f_X(x|Y=0) = \frac{f_{X,Y}(x, 0)}{f_Y(0)} \quad (13.2.8)$$

$$f_X(x|XY=0) = \frac{f_{X,Y}(x, 0)/|x|}{\int_{-\infty}^{\infty} f_{X,Y}(x, 0)/|x| dx} \quad (13.2.9)$$

Assume that X cannot take the value zero. Without changing the event $XY = 0$ it then can be written as $Y = 0$. But then the left hand sides of (13.2.8) and (13.2.9) become written with identical

symbols even though the right hand sides obviously are different. Therefore it is not advisable to cancel X in the event $XY = 0$ because the notation shows that the class of relevant sets that have the event $Y = 0$ as intersection must be defined by $\{(x, y) \in \mathbb{R}^2 \mid -\theta < xy \leq 0\}$ where $\theta \in \mathbb{R}_+$. If the condition is $Y = 0$ the defining class of events is given by $\{(x, y) \in \mathbb{R}^2 \mid -\theta < y \leq 0\}$ where $\theta \in \mathbb{R}_+$. \square

In (13.2.4) the numerator can be interpreted as a sensitivity of the reliability of the parallel system $\{M \leq 0\} \cap \{H \leq 0\}$ with respect to a parameter θ . The equation corresponding to the event $H + \theta = 0$ is

$$h(x) + \theta = 0 \quad (13.2.10)$$

The sensitivity is calculated for $\theta = 0$. The denominator can be interpreted in a similar way as the sensitivity of the probability $P(H \leq 0)$ with respect to θ for $\theta = 0$.

FORM-approximation*

In the standardized Gaussian space defined by the transformation $\mathbf{y} = T(\mathbf{x})$ the surface (13.2.10) becomes represented by the equation

$$h[T^{-1}(\mathbf{y})] + \theta = 0 \quad (13.2.11)$$

Then it follows from (8.2.10) that for the geometric event index (analogous to the geometric reliability index) β_H corresponding to H we have

$$\frac{d\beta_H}{d\theta} = \frac{1}{\|\nabla h[T^{-1}(\boldsymbol{\alpha}_H \beta_H)]\|} \quad (13.2.12)$$

where ∇ is the gradient operator with respect to \mathbf{y} and $\boldsymbol{\alpha}_H$ is the unit normal vector at the globally most central point on the surface defined by (13.2.11) for $\theta = 0$. For the denominator in (13.2.4) the FORM-approximation (8.2.33) therefore becomes

$$\left[\frac{\partial}{\partial \theta} P(H + \theta \leq 0) \right]_{\theta=0} \approx -\varphi(\beta_H) \frac{d\beta_H}{d\theta} \quad (13.2.13)$$

where $d\beta_H/d\theta$ is substituted from (13.2.12).

The FORM-approximation for the numerator in (13.2.4) is determined by using (8.3.4) and (8.3.5). For $q = 2$ the following formula is obtained from (8.3.5):

$$\frac{d\Phi_2(-\beta_1, -\beta_2; \rho)}{d\theta} = \left[-\frac{\partial \Phi_2}{\partial x_1} \frac{d\beta_1}{d\theta} - \frac{\partial \Phi_2}{\partial x_2} \frac{d\beta_2}{d\theta} + \frac{\partial \Phi_2}{\partial \rho} \frac{d\rho}{d\theta} \right]_{(-\beta_1, -\beta_2; \rho)} \quad (13.2.14)$$

From the formula, see Exercise 4.3,

$$\Phi_2(-\beta_1, -\beta_2; \rho) = \int_{-\infty}^{x_2} dy \int_{-\infty}^{x_1} \frac{1}{\sqrt{1-\rho^2}} \varphi\left(\frac{y-\rho x}{\sqrt{1-\rho^2}}\right) \varphi(x) dx \quad (13.2.15)$$

it is seen that

$$\frac{\partial \Phi_2(-\beta_1, -\beta_2; \rho)}{\partial x_2} = \int_{-\infty}^{-\beta_2} \frac{1}{\sqrt{1-\rho^2}} \varphi\left(\frac{y-\rho\beta_1}{\sqrt{1-\rho^2}}\right) \varphi(\beta_1) dy = \varphi(\beta_1) \Phi\left(-\frac{\beta_2-\rho\beta_1}{\sqrt{1-\rho^2}}\right) \quad (13.2.16)$$

while (8.3.7) gives

$$\frac{\partial \Phi_2}{\partial \rho} = \frac{\partial^2 \Phi_2}{\partial x_1 \partial x_2} \quad (13.2.17)$$

where the right side is identically equal to the two-dimensional normal density. Thus we have

$$\frac{\partial \Phi_2(-\beta_1, -\beta_2; \rho)}{\partial \rho} = \varphi(\beta_1) \frac{1}{\sqrt{1-\rho^2}} \varphi\left(-\frac{\beta_2-\rho\beta_1}{\sqrt{1-\rho^2}}\right) \quad (13.2.18)$$

For large values of $(\beta_2 - \rho\beta_1)/\sqrt{1-\rho^2}$ the ratio between (13.2.18) and (13.2.16) is of the order of size as $(\beta_2 - \rho\beta_1)/(1-\rho^2)$ (since $\Phi(-x) \sim \varphi(x)/x$ as $x \rightarrow \infty$). Except for ρ close to 1 (in the case $\beta_1 \neq \beta_2$) the derivatives (13.2.16) and (13.2.18) are thus not of essentially different order of size. However, without making a serious error, the last term in (13.2.14) can usually be canceled in the application (13.2.4). This is because the factor $d\rho/d\theta$ usually is small as compared to the derivative $d\beta_H/d\theta$. We have

$$\rho = \boldsymbol{\alpha}_{MH}^T \boldsymbol{\alpha}_{HM} \quad (13.2.19)$$

and thus

$$\frac{d\rho}{d\theta} = \boldsymbol{\alpha}_{MH}^T \frac{d\boldsymbol{\alpha}_{HM}}{d\theta} + \boldsymbol{\alpha}_{HM}^T \frac{d\boldsymbol{\alpha}_{MH}}{d\theta} \quad (13.2.20)$$

where $\boldsymbol{\alpha}_{MH}$ and $\boldsymbol{\alpha}_{HM}$ are the unit normal vectors to the surfaces that correspond to $M = 0$ and $H = 0$, respectively, and considered at the globally most central point of the intersection $\{M = 0\} \cap \{H = 0\}$ represented in the standard Gaussian space. If H is linear in the Gaussian variables, the surfaces corresponding to the events $H = 0$ and $H + \theta = 0$ become two parallel hyperplanes. In this case it then follows that $d\boldsymbol{\alpha}_{HM}/d\theta = \mathbf{0}$. Moreover, if the event $M = 0$ corresponds to a hyperplane, then also $d\boldsymbol{\alpha}_{MH}/d\theta = \mathbf{0}$. Using geometric considerations it can be seen that the derivatives $d\boldsymbol{\alpha}_{MH}/d\theta$ and $d\boldsymbol{\alpha}_{HM}/d\theta$ are proportional to the principal curvatures of the surface $M = 0$ and the surface $H = 0$, respectively, at the globally most central point. Assuming small curvatures, the last term in (13.2.14) will be disregarded.

While β_H denotes the geometric event index corresponding to H we will use the notation β_{HM} for the simple event index of the linear event margin defined by the tangent hyperplane to the surface $h[T^{-1}(\mathbf{y})] = 0$ at the globally most central point \mathbf{y}_{MH} of the intersection

$$\{\mathbf{y} | h[T^{-1}(\mathbf{y})] = 0\} \cap \{\mathbf{y} | g(\mathbf{y}) = 0\} \quad (13.2.21)$$

where $g(\mathbf{y}) = 0$ is the limit-state surface corresponding to the event $M = 0$. This hyperplane has the unit normal vector $\boldsymbol{\alpha}_{HM}$. Similarly β_{MH} denotes the simple reliability index of the linear safety margin defined by the tangent hyperplane to the surface $g(\mathbf{y}) = 0$ at the globally most central

point of the intersection. This hyperplane has the unit normal vector $\boldsymbol{\alpha}_{MH}$. With this notation the numerator in (13.2.4) becomes

$$\begin{aligned} \left[\frac{\partial}{\partial \theta} P(M \leq 0, H + \theta \leq 0) \right]_{\theta=0} &\approx \frac{d\Phi_2(-\beta_{MH}, -\beta_{HM}; \rho)}{d\theta} \approx \\ \left[-\frac{\partial \Phi_2}{\partial x_2} \frac{d\beta_{HM}}{d\theta} \right]_{(-\beta_{MH}, -\beta_{HM}; \rho)} &= \varphi(\beta_{HM}) \Phi \left(-\frac{\beta_{MH} - \rho \beta_{HM}}{\sqrt{1 - \rho^2}} \right) \frac{d\beta_{HM}}{d\theta} \end{aligned} \quad (13.2.22)$$

noting that $d\beta_{MH}/d\theta$ is neglected with reference to the assumption of small curvatures since $\beta_{MH} = \boldsymbol{\alpha}_{MH}^T \mathbf{y}_{MH}$, $\boldsymbol{\alpha}_{MH}^T d\mathbf{y}_{MH}/d\theta = 0$ and $d\boldsymbol{\alpha}_{MH}/d\theta \approx \mathbf{0}$. The correlation coefficient ρ is determined by (13.2.19), and

$$\frac{d\beta_{HM}}{d\theta} = \frac{1}{\|\nabla h[T^{-1}(\mathbf{y}_{MH})]\|} \quad (13.2.23)$$

is determined in the same way as (13.2.12) but with the globally most central point, see (8.3.8),

$$\mathbf{y}_{MH} = \begin{bmatrix} \boldsymbol{\alpha}_{MH}^T \\ \boldsymbol{\alpha}_{HM}^T \end{bmatrix}^{-1} \begin{bmatrix} \beta_{MH} \\ \beta_{HM} \end{bmatrix} \quad (13.2.24)$$

in the intersection (13.2.21) substituted in the place of $\boldsymbol{\alpha}_H \beta_H$. Thus we have by substitution of (13.2.13) and (13.2.22) in (13.2.4) that

$$P(M \leq 0 | H = 0) \approx \frac{\varphi(\beta_{HM})}{\varphi(\beta_H)} \Phi \left(-\frac{\beta_{MH} - \rho \beta_{HM}}{\sqrt{1 - \rho^2}} \right) \frac{\|\nabla h[T^{-1}(\boldsymbol{\alpha}_H \beta_H)]\|}{\|\nabla h[T^{-1}(\mathbf{y}_{MH})]\|} \quad (13.2.25)$$

If M and H are linear in the Gaussian variables we have $\beta_{HM} = \beta_H$, $\beta_{MH} = \beta_M$ and the two gradient vector lengths are equal. Thus the result (13.2.25) becomes

$$P(M \leq 0 | H = 0) = \Phi \left(-\frac{\beta_M - \rho \beta_H}{\sqrt{1 - \rho^2}} \right) = \Phi(-\beta_{M|H=0}) \quad (13.2.26)$$

where the conditional reliability index $\beta_{M|H=0}$ is introduced from (8.1.6). The result (13.2.26) is exact.

With k relations of the second information type the formula (13.2.4) is directly generalized to

$$\begin{aligned} &P(M \leq 0 | H_1 = 0, \dots, H_k = 0) \\ &= \left[\frac{\frac{\partial^k}{\partial \theta_1 \dots \partial \theta_k} P(M \leq 0, H_1 + \theta_1 \leq 0, \dots, H_k + \theta_k \leq 0)}{\frac{\partial^k}{\partial \theta_1 \dots \partial \theta_k} P(H_1 + \theta_1 \leq 0, \dots, H_k + \theta_k \leq 0)} \right]_{\boldsymbol{\theta}=0} \end{aligned} \quad (13.2.27)$$

which by use of the FORM-approximation (8.3.4) becomes

$$\approx \frac{\frac{\partial^k}{\partial \theta_1 \dots \partial \theta_k} \Phi_{k+1}(-\tilde{\boldsymbol{\beta}}_{k+1}, \mathbf{P}_{k+1})}{\frac{\partial^k}{\partial \theta_1 \dots \partial \theta_k} \Phi_k(-\boldsymbol{\beta}_k, \mathbf{P}_k)} \quad (13.2.28)$$

Here $\tilde{\boldsymbol{\beta}}_{k+1}$ is the vector of event indices $\tilde{\beta}_0 = \beta_{M(H_1 \dots H_k)}$, $\tilde{\beta}_1 = \beta_{H_1(MH_2 \dots H_k)}$, \dots , $\tilde{\beta}_k = \beta_{H_k(MH_1 \dots H_{k-1})}$, defined similarly as β_{MH} and β_{HM} . The correlation matrix \mathbf{P}_{k+1} is defined by the scalar products between the unit normal vectors $\tilde{\boldsymbol{\alpha}}_0 = \boldsymbol{\alpha}_{M(H_1 \dots H_k)}$, $\tilde{\boldsymbol{\alpha}}_1 = \boldsymbol{\alpha}_{H_1(MH_2 \dots H_k)}$, \dots , $\tilde{\boldsymbol{\alpha}}_k = \boldsymbol{\alpha}_{H_k(MH_1 \dots H_{k-1})}$. Correspondingly $\boldsymbol{\beta}_k$ is the vector of event indices $\beta_1 = \beta_{H_1(H_2 \dots H_k)}$, $\beta_2 = \beta_{H_2(H_1 H_3 \dots H_k)}$, \dots , $\beta_k = \beta_{H_k(H_2 \dots H_{k-1})}$, while the correlation matrix \mathbf{P}_k is defined by the scalar products between the unit normal vectors $\boldsymbol{\alpha}_1 = \boldsymbol{\alpha}_{H_1(H_2 \dots H_k)}$, \dots , $\boldsymbol{\alpha}_k = \boldsymbol{\alpha}_{H_k(H_2 \dots H_{k-1})}$. All these event indices and unit normal vectors are functions of $(\theta_1, \dots, \theta_k)$. It is noted that

$$\frac{\partial \tilde{\beta}_0}{\partial \theta_i} \equiv 0 \quad \text{for } i = 1, \dots, k \quad (13.2.29)$$

$$\frac{\partial \tilde{\beta}_j}{\partial \theta_i} \equiv \frac{\partial \beta_j}{\partial \theta_i} \equiv 0 \quad \text{for } i \neq j \quad (13.2.30)$$

$$\frac{\partial \tilde{\beta}_i}{\partial \theta_i} = \frac{1}{\|\nabla h_i[T^{-1}(\mathbf{y}_{MH_1 \dots H_k})]\|} \quad (13.2.31)$$

$$\frac{\partial \beta_i}{\partial \theta_i} = \frac{1}{\|\nabla h_i[T^{-1}(\mathbf{y}_{H_1 \dots H_k})]\|} \quad (13.2.32)$$

$$\mathbf{y}_{MH_1 \dots H_k} = \begin{bmatrix} \tilde{\boldsymbol{\alpha}}_0^\top \\ \tilde{\boldsymbol{\alpha}}_1^\top \\ \vdots \\ \tilde{\boldsymbol{\alpha}}_k^\top \end{bmatrix}^{-1} \begin{bmatrix} \tilde{\beta}_0 \\ \tilde{\beta}_1 \\ \vdots \\ \tilde{\beta}_k \end{bmatrix} \quad \mathbf{y}_{H_1 \dots H_k} = \begin{bmatrix} \boldsymbol{\alpha}_1^\top \\ \vdots \\ \boldsymbol{\alpha}_k^\top \end{bmatrix}^{-1} \begin{bmatrix} \beta_1 \\ \vdots \\ \beta_k \end{bmatrix} \quad (13.2.33)$$

It follows from (13.2.29) and (13.2.30) that the mixed derivatives of $\tilde{\beta}_0, \dots, \tilde{\beta}_k, \beta_1, \dots, \beta_k$ all are zero. If the derivatives of the correlation coefficients are disregarded as above, (13.2.28) is reduced to

$$P(M \leq 0 | H_1 = 0, \dots, H_k = 0) \approx \frac{\varphi_k(\tilde{\beta}_1, \dots, \tilde{\beta}_k; \{\tilde{\boldsymbol{\alpha}}_i^\top \tilde{\boldsymbol{\alpha}}_j\})}{\varphi_k(\beta_1, \dots, \beta_k; \{\boldsymbol{\alpha}_i^\top \boldsymbol{\alpha}_j\})} \Phi \left(\frac{-\hat{E}[\tilde{M} | \tilde{H}_1 = 0, \dots, \tilde{H}_k = 0]}{\sqrt{1 - \rho[\tilde{M}; (\tilde{H}_1, \dots, \tilde{H}_k)]^2}} \right) \prod_{i=1}^k \frac{\|\nabla h_i[T^{-1}(\mathbf{y}_{H_1 \dots H_k})]\|}{\|\nabla h_i[T^{-1}(\mathbf{y}_{MH_1 \dots H_k})]\|} \quad (13.2.34)$$

where $\tilde{M}, \tilde{H}_1, \dots, \tilde{H}_k$ are the event margins with mean values $\tilde{\beta}_0, \tilde{\beta}_1, \dots, \tilde{\beta}_k$ and standard deviations 1 that correspond to the tangent hyperplanes at $\mathbf{y}_{MH_1 \dots H_k}$. The linear regression $\hat{E}[\tilde{M} | \tilde{H}_1 = 0, \dots, \tilde{H}_k = 0]$ is calculated by use of (4.3.4) and the multiple correlation coefficient $\rho[\tilde{M}; (\tilde{H}_1, \dots, \tilde{H}_k)]$ is calculated by use of (4.4.17).

If M, H_1, \dots, H_k all are linear in the Gaussian variables we obtain the exact result, see (4.4.14),

$$P(M \leq 0 | H_1 = 0, \dots, H_k = 0) = \Phi \left(\frac{-\hat{E}[\tilde{M} | \tilde{H}_1 = 0, \dots, \tilde{H}_k = 0]}{\sqrt{1 - \rho[\tilde{M}; (\tilde{H}_1, \dots, \tilde{H}_k)]^2}} \right) = \Phi(-\beta_{M|\mathbf{H} = \mathbf{0}}) \quad (13.2.35)$$

Formulas for mixtures of the two information types can be constructed according to similar principles.

Example 13.3 The creep and shrinkage properties of concrete are often more uncertain than the strength properties. This is of particular importance when designing prestressed concrete structures. For such structures the choice of the prestressing and the poststressing arrangements with the corresponding stress levels are often made such that the creep and shrinkage deformations become small. Considering the large uncertainty it can be useful to revise the poststressing levels on the basis of a probabilistic model using updating from observed deformations during the construction phase or later on.

As an example consider the prestress loss in a prismatic prestressed concrete beam with the cross-section shown in Fig. 13.4. At time t the force in the prestressing cable is denoted as $N(t)$. With $N(0)$ given, $N(t)$ varies as a function of t as a random variable with distributional properties that depend on the joint distribution of a set of random input variables in the mathematical model that defines $N(t)$. The results shown in the following figures are obtained on the basis of the usual linear visco-elastic Bernoulli beam theory applied to prestressed concrete beams. The creep and shrinkage parameters that are needed in this theory are defined in terms of the input variables on the basis of empirical models formulated by Bazant and Panula [13.1]. The elements of the random input vector \mathbf{X} are humidity X_1 , cement content X_2 , water-cement ratio X_3 , gravel-cement ratio X_4 , 28-day cylinder strength X_5 , additive model uncertainty of the shrinkage model X_6 , additive model uncertainty of the model for the so-called basic creep X_7 , and additive model uncertainty of the model for the so-called drying creep X_8 . All eight input variables are assumed to be mutually independent and distributed according to the normal distribution with realistic values of the mean values and the standard deviations. These values will not be reported here but they are given in [13.3].

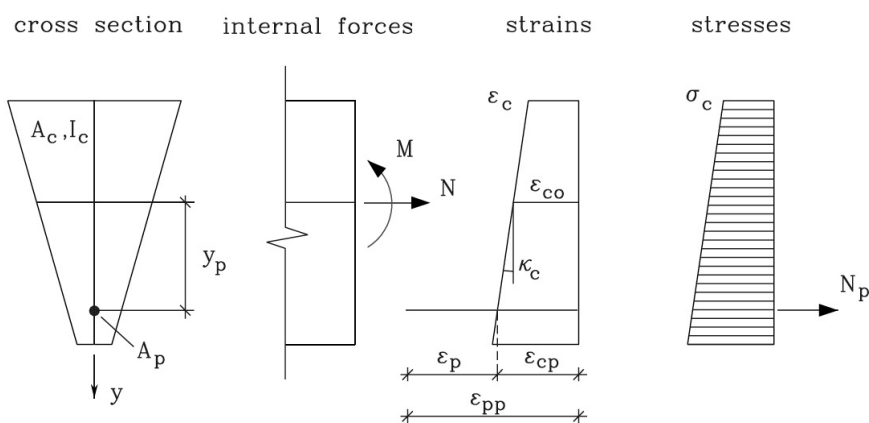

Figure 13.4: Cross-section of prestressed concrete beam.

The distribution function for the prestressing force $N(t)$ can be calculated for the argument n by calculating the failure probability associated to the safety margin $M = N(t) - n$. The distribution function shown in Fig. 13.5 (marked “original curve”) is calculated by use of FORM for different values of n . Also the sensitivity factors with respect to the eight random input variables are calculated. For $n = 2.5$ MN the following sensitivity factors (= squares of the components of α , where α is the unit vector directed from the origin to the globally most central limit-state point

in the standard Gaussian space, see Section 8.1) were obtained: (4.2, 0.0, 0.3, 0.4, 1.4, 0.5, 93.1, 0.1) (times 0.01). From this it is seen that the dominant contribution to the uncertainty comes from the uncertainty of the model for the basic creep.

After the beam has been fabricated and built in at its permanent position, measurements of the displacements of the midpoint of the beam are made at different time points. The displacement $u(t)$ is measured at a time t_0 directly after the application of the load and at a later time t_1 . The measuring uncertainty is considered in terms of the difference Δ which is assumed to be a Gaussian random variable. Then the event margin is $H_1 = u(t_1) - u(t_0) - \Delta_1$. The event margin $H_2 = u(t_2) - u(t_0) - \Delta_2$ corresponds to a displacement measurement at the time $t_2 > t_1$, etc. After the time $t_n, n = 1, 2, \dots$, the updated distribution function $P[N(T) \leq n | H_1 = 0, \dots, H_n = 0]$ is calculated.

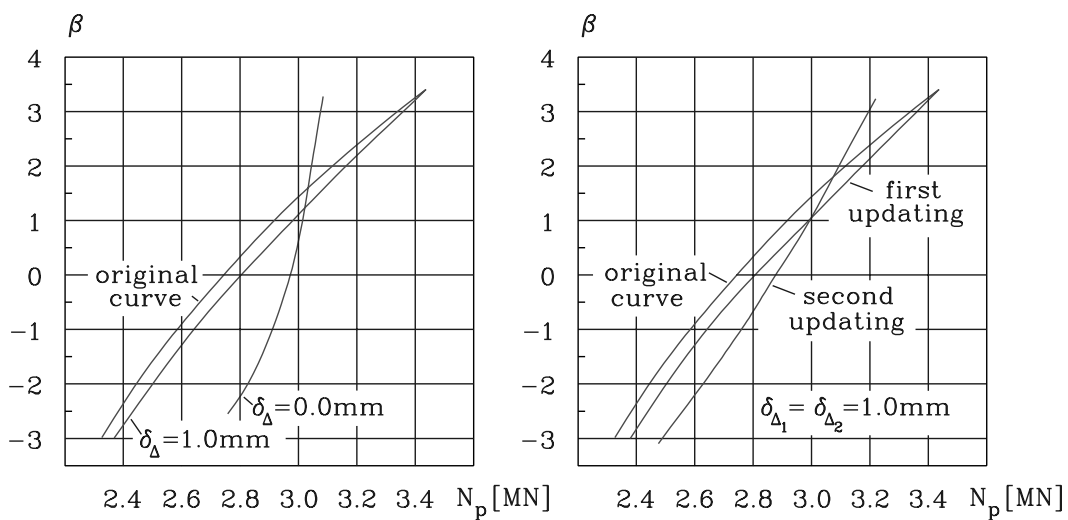

Figure 13.5: Distribution functions before and after updating with respect to the prestressing force $N(10.000 \text{ days})$ for the concrete beam with cross-section as in Fig. 13.4 and with span 10 m and bending moment 1 MNm. (The ordinate axis scale is the fractile scale for the standardized normal distribution, and $\delta_\Delta = D[\Delta]$.)

To the left in Fig. 13.5 the original distribution function is shown together with two updated distribution functions that correspond to zero measuring uncertainty $D[\Delta_1] = 0$ and a measuring uncertainty of $D[\Delta_1] = 1 \text{ mm}$, respectively. These updated distribution functions are obtained after a displacement measurement at the time $t_1 = 1 \text{ year}$ ($t_0 = 1 \text{ day}$) resulting in $E[\Delta_1] = -4 \text{ mm}$. It is seen that the influence of the measuring uncertainty on the updating information is quite essential. To the right in Fig. 13.5, two of the curves are the same as in the left side while the third curve corresponds to an updating after a measurement at the time $t_2 = 10 \text{ years}$. The measuring uncertainties are $D[\Delta_1] = D[\Delta_2] = 1 \text{ mm}$ and Δ_1, Δ_2 are assumed to be mutually independent. The updating after 10 years has given a considerable reduction of the uncertainty of the prestressing force. (The assumption about independence between Δ_1 and Δ_2 is applicable if the displacement measurement at time t_0 is made with considerable larger accuracy than the later displacement measurements and all the measurements are mutually independent. The last assumption implies that $\text{Cov}[\Delta_1, \Delta_2]$ equals the variance of the displacement measurement at time t_0). \square

Example 13.4 Alternating stresses in a structure may cause growth of so-called fatigue cracks. This possibility of crack growth is often decisive for the reliability of several types of steel and aluminum structures. Failure can show up in many ways for example as local leakage (in pipelines and containers), as local or global brittle fracture, or as a global ductile failure triggered from a local fracture. Often the relevant failure criteria can be based on the existence of a critical crack length that depends on the toughness of the material. Both this toughness and the parameters that influence the crack growth are generally encumbered with large uncertainty.

As an illustration consider a crack in a plate subject to cyclically varying stresses in the plane of the plate and orthogonal to the crack. Far away from the crack the cyclic stress state is homogeneous and uniaxial with the constant stress range S . At the crack tip the stresses are intensified in a way described by the so-called stress intensity factor. In terms of linear elasticity theory this stress intensity factor can be deduced to be $\sqrt{\pi x}$, where x is half the crack length. This result is based on the assumption that the crack is situated far away from the boundaries of the plate. If this is not the case the factor $\sqrt{\pi x}$ is modified by multiplication with a function of x which is almost constant and equal to 1 for small values of x . This function depends on one or more geometric quantities that fix the crack position and orientation relative to the boundaries of the plate. Therefore the function is called the geometry function. With sufficient accuracy the geometry function can be put to 1 in this example.

Experimental investigations have shown that the increment Δx per stress period (per cycle) of the crack length can be approximated by

$$\Delta x = C(\sqrt{\pi x}S)^m \quad (13.2.36)$$

where C and m are material constants. This equation is known as the Paris-Erdogan law for crack growth. Often the crack length increment Δx per cycle is very small as compared to the variation of $x^{m/2}$. Therefore Δx can be idealized to be the differential quotient dx/dn where n is the number of cycles considered as a continuous parameter. Then (13.2.36) becomes a differential equation in which the variables x and n can be separated. Written as a random variable $X(n)$ the solution becomes

$$X(n) = \left[\left(1 - \frac{m}{2}\right) C \pi^{m/2} S^m n + X_1^{1-m/2} \right]^{(1-m/2)^{-1}} \quad (13.2.37)$$

where X_1 is the random initial crack length. Let X_2 be the random critical crack length with respect to which we have the safety margin

$$M(n) = X_2 - \left[\left(1 - \frac{1}{2} X_4\right) X_5 (\sqrt{\pi} X_3)^{X_4} n + X_1^{1-\frac{1}{2} X_4} \right]^{(1-\frac{1}{2} X_4)^{-1}} \quad (13.2.38)$$

where $X_3 = S$, $X_4 = m$, $X_5 = C$.

The random variables X_1, X_2, X_3 and the pair (X_4, X_5) are assumed to be mutually independent in what follows. However, the random variables X_4 and X_5 are correlated to a degree that depends on the chosen physical unit system. (Since the formula (13.2.36) must be correct as to physical dimension the unit for the constant C besides depending on the units for length and stress also depends on the dimensionless exponent m). The units for length and stress are here mm and N/mm², respectively. The following distributional assumptions are given: X_1 has exponential distribution

with mean value 1, X_2 has normal distribution with mean value 50 and standard deviation 10, X_3 has normal distribution with mean value 60 and standard deviation 10, $(X_4, \log X_5)$ has joint normal distribution with mean value point (3.5, -33.00), standard deviations (0.3, 0.47), and correlation coefficient -0.9.

The distribution function for the number N of cycles to failure is $P(N \leq n) = P[M(n) \leq 0]$ and the FORM-approximation to it is shown as the straight line in Fig. 13.7. For $n = 1.5 \times 10^6$ cycles the sensitivity factors are obtained as

$$(\alpha_1^2, \alpha_2^2, \alpha_3^2, \alpha_4^2 + \alpha_5^2) = (30, 0, 13, 57)\% \quad (13.2.39)$$

where α_4^2 and α_5^2 are not separated because X_4 and X_5 are strongly correlated. Structures in which dangerous crack growth can occur are usually more or less regularly subject to inspections for cracks. In particular such inspections are made at the so-called "hot-spots", that is, points in the structure with predicted strong concentration of stresses. Assume that a crack has been detected after n_j cycles and that the crack length has been measured. Due to measuring uncertainty this measurement does not reveal the exact crack length but, by repeated measurements, rather the parameters of the distribution of a random variable A_j that represents the crack length. A measurement like this may be made at several time points giving a number of event margins

$$H_j = A_j - X(n_j), \quad j = 1, \dots, s \quad (13.2.40)$$

with $X(n)$ given by (13.2.37). The collected information is of the type $H_1 = 0, \dots, H_s = 0$, that is, relation information of the second type.

It may happen (and hopefully often so) that no crack is found at the inspection after n_i cycles. Thus information of the first type is obtained giving the event margin

$$H_i = X(n_i) - B_i \quad (13.2.41)$$

in which B_i is a random variable that represents a length below which a crack cannot be detected with the given measuring technique. Such an inspection result obtained successively r times thus gives the information $H_1 \leq 0, \dots, H_r \leq 0$ of the first type. In the formulation (13.2.41) it is assumed that, with probability 1, there is at least one small crack in the close vicinity of the considered "hot spot" already before the start of the cyclic stressing. Besides it is a condition for the validity of the Paris-Erdogan law that the initial crack is larger than a certain smallest size. It is obvious that if B_i is deterministic and has the same value for all inspections, then the entire information is contained in the last inequality $H_r \leq 0$.

The general situation is that a crack is detected for the first time at the $(r+1)$ th inspection. Then after $r+s$ inspections the collected information gives the following updated distribution function for the cycle number N until the occurrence of failure:

$$\begin{aligned} P(N \leq n | X(n_1) \leq B_1, \dots, X(n_r) \leq B_r, X(n_{r+1}) = A_{r+1}, \dots, X(n_{r+s}) = A_{r+s}) \\ = P(M(n) \leq 0 | H_1 \leq 0, \dots, H_r \leq 0, H_{r+1} = 0, \dots, H_{r+s} = 0) \end{aligned} \quad (13.2.42)$$

Further generalization deals with simultaneous inspection at several "hot spots". Under due consideration of the mutual dependency that may exist between the input variables associated to several positions in the structure the updating can be made according to the explained principles.

Some illustrative examples:

a) Let us consider an example in which a crack is observed after $n_1 = 10^5$ cycles. For the random crack length A_1 the measurement gives the mean value $E[A_1] = 3.9$ mm. It is assumed that A_1 is normally distributed with standard deviation σ_A expressing the measurement accuracy. The crack is not repaired but a new measurement is made after $n_2 = 2 \times 10^5$ cycles by use of the same measurement technique. The mean value $E[A] = 4.0$ mm is obtained. Figure 13.6 shows the updated distribution functions for N after the second inspection in dependence of different assumed values of σ_A . The results in Fig. 13.6 are based on the assumption that A_1 and A_2 are mutually independent. The measurement accuracy is seen to have a very large influence.

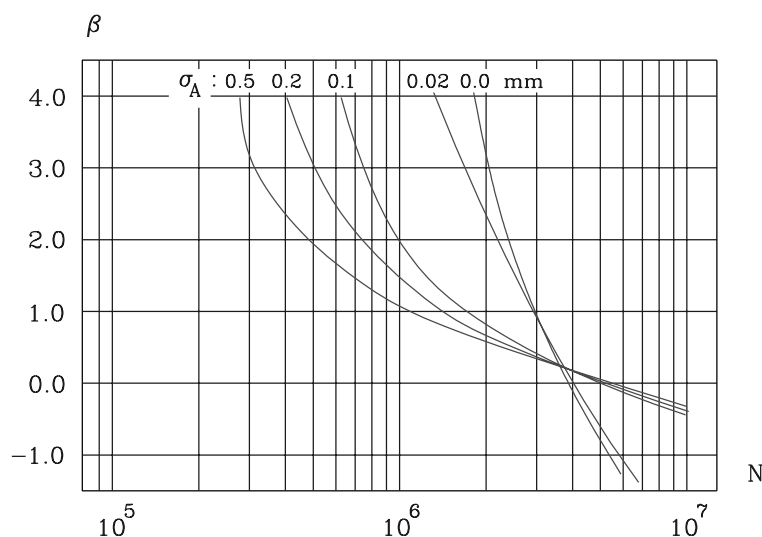

Figure 13.6: Updated distribution functions for number of cycles N to failure after two inspections of a crack with observed mean crack lengths of 3.9 mm at the first inspection and 4.0 mm at the second inspection. The influence of the measuring uncertainty is illustrated by different choices of σ_A . (The ordinate axis scale is the fractile scale for the standardized normal distribution.)

b) If the situation is that no crack is observed at the first inspection at $n_1 = 10^5$ cycles, the distribution properties of the detection limit B_1 enters the updating. With the assumption that B_1 has exponential distribution with mean value λ , Fig. 13.7 shows the distribution functions for N corresponding to different values of λ . These values of λ reflect the quality of the inspection technique. The figure also shows the distribution function before the updating. If the reliability requirement is formulated such that the reliability index must be at least 3 throughout a presupposed service time of the structure of 1.5×10^6 cycles, it is seen from the figure that it is not needed to make more inspections if $\lambda \leq 0.3$. For larger values of λ new inspections should be made at time points that can be read at the successively updated distribution function intersections with the level $\beta = 3$.

c) We may also study the effect of gathering new information after a crack has been repaired. The result depends very much of whether the repair has been made such that the material around the crack has been completely renewed or whether it is still the old material. In the first case the new material parameters can be assumed to be stochastically independent of the old parameters

while they are unchanged in the second case. Possibly a certain mixing of the old and the new material parameters may take place introducing correlation between the parameters before and after the repair.

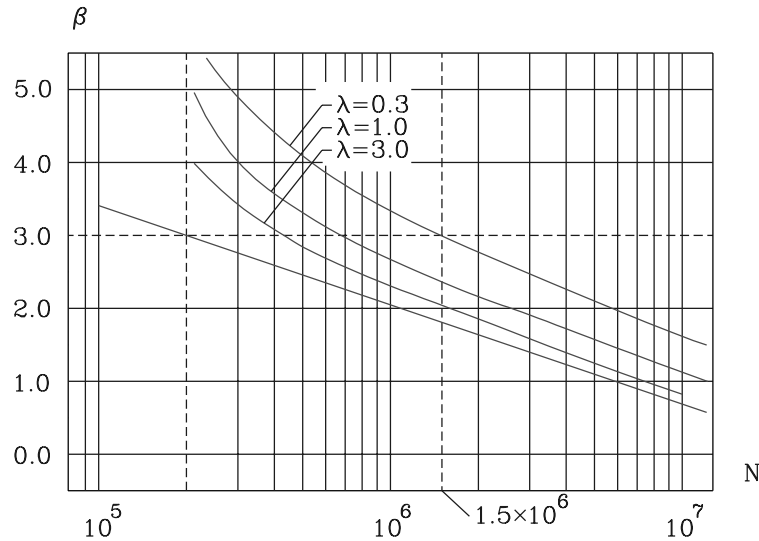

Figure 13.7: Updated distribution functions for number of cycles N to failure after an inspection where no crack is detected. The mean value of the detection limit is λ . The lowest curve is the approximate distribution function before the updating as obtained by FORM. (The ordinate axis scale is the fractile scale for the standardized normal distribution.)

Assume that a repair is made after n_{rep} cycles at a crack length represented by the random variable A_{rep} . In this situation we formulate the event margin

$$H_{rep} = A_{rep} - X(n_{rep}) \tag{13.2.43}$$

of the type as in (13.2.40). The updated distribution function for N then becomes

$$P(N \leq n | H_{rep} = 0) = P(M_{rep}(n) \leq 0 | H_{rep} = 0) \tag{13.2.44}$$

where $M_{rep}(n)$ is a safety margin different from $M(n)$ given in (13.2.38). We have

$$M_{rep}(n) = X_2 - [(1 - \frac{1}{2} Y_4) Y_5 (\sqrt{\pi} X_3)^{Y_4} (n - n_{rep}) + Y_1^{1 - \frac{1}{2} Y_4} (1 - \frac{1}{2} Y_4)^{-1}] \tag{13.2.45}$$

in which Y_1 is a new random initial length of a crack assumed to exist at the “hot spot” just after the repair, while (Y_4, Y_5) corresponds to a new value pair of (m, C) with the same distribution as (X_4, X_5) . If the material parameters have the same values before and after the repair the random pair (Y_4, Y_5) in (13.2.45) is replaced by (X_4, X_5) .

Figure 13.8 shows the distribution function for N after a repair of a crack with mean length $E[A_{rep}] = 8$ mm for $n_{rep} = 2 \times 10^5$ cycles. It is assumed that Y_1 has the same exponential distribution as X_1 . It is seen that there is an immediate increase of the reliability after the repair but also that

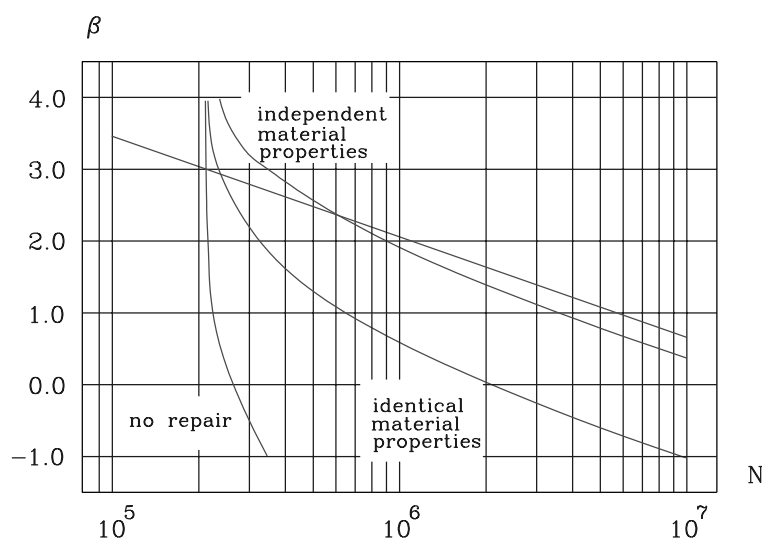

Figure 13.8: Updated distribution functions for number of cycles N to failure after an inspection and crack length measurement which has been followed by a repair of the crack. The repaired crack length has the mean $E[A_{\text{rep}}] = 8$ mm corresponding to $n_{\text{rep}} = 2 \times 10^5$ cycles. (The ordinate axis scale is the fractile scale for the standardized normal distribution.)

the reliability drops fast to a level under the level defined by the original distribution function before any updating. This reflects that the information about the large mean crack length $E[A_{\text{rep}}]$ at n_{rep} cycles contains the information that the stress range X_3 has taken a relatively large value. According to our model this large value acts also after the repair. \square

13.3 Decision criteria for existing structures*

Usually a structure is designed such that it satisfies a codified safety requirement. This requirement is related to some formal calculational model and it is proved to be satisfied by use of the information available at the time of design. The codified requirement is in its nature equivalent to a requirement that the generalized reliability index β_{prior} with respect to a given limit state is not smaller than a specified value β_{target} . The notation indicates that the reliability index corresponds to the design phase, that is, to a time period before the structure is realized and thus before information based on the existence of the structure is available.

Following the principles explained in the previous sections, collection of information after the realization of the structure makes it possible to calculate an updated reliability index $\beta_{\text{posterior}}$. While the code requirement

$$\beta_{\text{prior}} \geq \beta_{\text{target}} \quad (13.3.1)$$

has a rational explanation consistent with decision theoretical considerations made from the point of view of the public society, see Section 12.3, it is less clear whether rational decision theoretical

arguments can be given for a code requirement like

$$\beta_{\text{posterior}} \geq \beta_{\text{target}} \quad (13.3.2)$$

It will be shown in the following that (13.3.2) as a criterion for not making further actions with respect to the reliability of an existing structure in fact can be based on decision theoretical arguments. However, (13.3.2) is not a necessary condition for sufficient reliability of an existing structure.

In order to show the validity of these two statements we must consider the possible actions that may lead to changes of the existing structure and the consequences of these actions. In principle there are three action categories: (a) let the structure be unchanged, (b) strengthen the structure and/or change its use, (c) demolish the structure and replace it with a new structure. The action category (b) may embrace several alternative actions corresponding to alternative structural strengthening designs and/or possibilities of use. The same holds for the action category (c) since there may be a choice between different demolition methods and also many alternative designs of the new structure.

As in Section 12.3 the consideration will be made in terms of a simplified cost function. Let the capital investment in a strengthening system of a given type be given as a function $e(\beta)$ of the reliability index β for the strengthened structure. This function can be written as

$$e(\beta) = \begin{cases} k + h(\beta) & \text{for } \beta > \beta_{\text{posterior}} \\ 0 & \text{for } \beta = \beta_{\text{posterior}} \end{cases} \quad (13.3.3)$$

where k is a constant initial cost of starting up the strengthening work of the given type while $h(\beta)$ is an increasing function of β defined for $\beta \geq \beta_{\text{posterior}}$ and starting at the value zero, see Fig. 13.9. The cost function $e(\beta)$ is not defined for $\beta < \beta_{\text{posterior}}$ because any structural strengthening system has the purpose of increasing the reliability level beyond the value $\beta_{\text{posterior}}$. Including the optimal capital investment in a new structure in the direct cost d of the failure event, the total expected cost is then

$$\Phi(\beta)[k + h(\beta)] + \Phi(-\beta)d \approx k + h(\beta) + \Phi(-\beta)d \quad (13.3.4)$$

where $\Phi(-\beta)$ is the theoretical failure probability as a function of β . Reasoning as in Section 12.6 we have for simplicity neglected contributions to (13.3.4) that comes from the probability of the occurrence of mistakes. In case no strengthening is made, (13.3.4) is replaced by

$$\Phi(-\beta_{\text{posterior}})d \quad (13.3.5)$$

Comparison of (13.3.4) and (13.3.5) leads to the following decision rule:

1. If there is a solution $\beta_0 > \beta_{\text{posterior}}$ to the equation

$$h'(\beta) - \varphi(\beta)d = 0 \quad (13.3.6)$$

so that

$$k + h(\beta_0) < [\Phi(-\beta_{\text{posterior}}) - \Phi(-\beta_0)]d \quad (13.3.7)$$

then a strengthening of the structure should be made. It is not necessarily the considered strengthening design that should be realized. Possibly an alternative design may correspond to a less expected cost.

2. If there is no such solution to (13.3.6) then the considered strengthening design should not be realized. This does not exclude that an alternative design of the strengthening system should be realized.

If $\beta_{\text{posterior}}$ is considerably smaller than β_{target} , the best decision can turn out to be to choose an action of the third category, that is, demolition and replacement by a new structure. Let $c_{\text{demolition}}$ be the optimal cost for a demolition and let β_{target} be the optimal reliability index for the new structure with the corresponding optimal capital investment c_{new} . Then we can conclude that an action of the third category is not optimal if the criterion

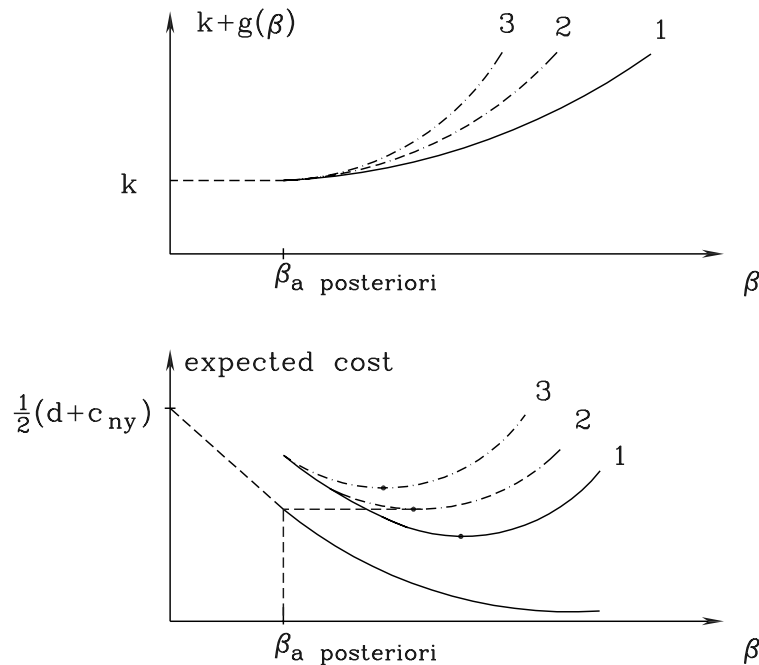

Figure 13.9: Illustration of the expected cost curve of making strengthening. In the case of the curve 1 the best decision is to make a strengthening. In the case of the curve 3 the best decision is not to use the considered type of strengthening. The curve 2 shows indifference. Possibly then there is an alternative design of the strengthening system that should be preferred as alternative to letting the structure be unchanged. (The curves are schematic, $\frac{1}{2}(d + c_{ny})$ should be changed to $\frac{1}{2}d$).

$$c_{\text{demolition}} + c_{\text{new}} + \Phi(-\beta_{\text{target}})d > \Phi(-\beta_{\text{posterior}})d \tag{13.3.8}$$

is satisfied. The right side of (13.3.8) is the expected cost by letting the existing structure be unchanged. Usually it is so that $c_{\text{demolition}} \ll c_{\text{new}}$, implying that $c_{\text{demolition}}$ can be neglected in the following. Then (13.3.8) can be rewritten as the criterion

$$\Phi(-\beta_{\text{posterior}}) < \Phi(-\beta_{\text{target}}) + \frac{c_{\text{new}}}{d} \tag{13.3.9}$$

Unless the right side defines a suitably small probability, society will hardly allow an application of this criterion. Thus it is seen that it should be required not only that d is large but also that

$$\frac{c_{\text{new}}}{d} \ll 1 \quad (13.3.10)$$

This is consistent with the considerations in Example 12.2 concerning the size of d . It was argued that d/c_{new} is of the order of size 10^4 (for $\beta_{\text{target}} = 4$) to 10^6 (for $\beta_{\text{target}} = 5$) which is of an order of size of 10 times larger than the first term $\Phi(-\beta_{\text{target}})$ on the right side of (13.3.9). Considering this we can with sufficient accuracy reduce (13.3.9) to the criterion

$$\beta_{\text{posterior}} > \Phi^{-1}\left(\frac{c_{\text{new}}}{d}\right) \quad (13.3.11)$$

If this criterion is satisfied a demolition and a complete renewal should not be made. It is noted that neglecting $c_{\text{demolition}}$ and $\Phi(-\beta_{\text{target}})$ in the reduction from (13.3.8) to (13.3.11) is conservatively in favor of demolition. If (13.3.11) is not satisfied, the choice is between strengthening of the existing structure or total renewal. If (13.3.11) is satisfied, the choice is between letting the structure be unchanged or to strengthen it.

Finally it will be shown that for the practical decision situation the criterion (13.3.2) is a sufficiently accurate condition for doing nothing after the updating of the reliability. Let k_{min} be the smallest value of k for the strengthening systems that are relevant in the given practical situation. Then it is clear that no one of these strengthening systems satisfies the criterion (13.3.7) if

$$k_{\text{min}} \geq \Phi(-\beta_{\text{posterior}})d \quad (13.3.12)$$

Thus this condition is a criterion for doing nothing. Then it is seen that if

$$k_{\text{min}} \geq \Phi(-\beta_{\text{target}})d \quad (13.3.13)$$

then the validity of the inequality

$$\beta_{\text{posterior}} \geq \beta_{\text{target}} \quad (13.3.14)$$

is also a criterion for doing nothing since (13.3.13) and (13.3.14) together imply (13.3.12). Since the right side of (13.3.13) after division by c_{new} as previously noted is of the order of size 10^{-1} , the inequality (13.3.13) is likely to be satisfied in many practical cases. Therefore we can conclude that the simple canonical decision criterion (13.3.14) in practice often will be consistent with optimal decision making.

A discussion that includes the probabilities of occurrences of mistakes is given in [13.2]. The criteria (13.3.11) and (13.3.14) are unchanged. The sole modification of some importance for the choice of action is in the inequality (13.3.7). In the parenthesis [...] an extra term is the difference between $p_0 = P$ (failure and mistakes for the unchanged structure) and $p_1 = P$ (failure and mistakes for the strengthened structure), see Section 12.3. This term, $p_0 - p_1$, can be judged to be negative because p_0 is the *posterior* probability corresponding to the information that the structure has survived until the present. This fact makes it reasonable to assume that at least some of the possible and more grave mistakes that could have been made during design, construction and use of the

existing structure actually have not been made and therefore can be disregarded as possibilities. However, there may still have been mistakes with hidden effects in the existing structure and to these can be added mistakes made during the design and the realization of the strengthening. This pulls in the direction of increasing the probability of the occurrence of mistakes with serious effects on the strengthened structure. On the other hand, the strengthening can decrease the seriousness of the possibly hidden effects of mistakes in the existing structure. All in all, though, it seems reasonable to assume that $p_1 \geq p_0$. This implies that the right side of (13.3.7) becomes smaller, which is a change in favor of not making the strengthening.

13.4 Updating by revision of the limit state

Sometimes the largest reliability updating effect can be obtained by making a revision of the mathematical model used in the design phase to represent the verbally formulated limit-state requirement. This is particularly relevant if the applied mathematical limit state is "on the safe side". It was shown in Chapter 3 how model uncertainty can be handled in the reliability analysis both with respect to bias in the mean position of the limit-state surface and with respect to the variation about the mean position in a neighborhood of the globally most central limit-state point. The practice of applying models that are on the safe side implies that no correction is made in the design phase in order to achieve correctness in the mean and also often that model uncertainty related to the applied model is disregarded. Such an "on the safe side" procedure is not necessarily optimal, naturally, even though considerations about investment of time in the structural analysis pulls in the direction of simplicity. Nonetheless it is and it has been a wide spread practice. Of course, this has been so to a larger degree for older structures that have been designed by use of very primitive calculational aids.

For structures designed "on the safe side" a change of the limit-state surface by reference to a more detailed and non-biased mathematical model leads to an extension of the safe set and thus an increase of the calculated reliability. The necessary inclusion of model uncertainty pulls in the opposite direction, of course.

By the application of the principle of consequence calculations for calibration of different codes against each other, this issue should be remembered. If given safety elements (safety factors, partial safety factors, characteristic values, etc.) are assigned to specified limit-state surfaces chosen on the safe side (or possibly even on the unsafe side) these biases should be carefully considered when making the calibration such that "hidden safeties" are taken care of in a correct way in the consequence calculations.

13.5 Historical and bibliographical notes

In the framework of the usual deterministic methods for design according to the partial safety factor method it is very difficult if not impossible in a rational way to include new information as described in this chapter. Therefore it is not surprising that practical applications of probabilistic methods gain a place for the evaluation of existing structures. For example it can be observed that

inspection for fatigue cracks in all the Danish offshore structures are based on principles that are based on the models for crack growth and inspection described in this chapter [13.6].

The calculational problems were solved in connection with the development of FORM for parallel systems. H.O. Madsen [13.4], R. Rackwitz and K. Schrupp [13.7] have presented the first results in this direction in 1985. A more complete description is given by H.O. Madsen in 1987 [13.5].

It should be expected that probabilistic methods in the future will get wide spread applications for existing structures. Applications on bridge structures are under development both in USA and in Europe.

Bibliography

- [13.1] Bazant, Z.P., and Panula, L. (1978/1979) Practical prediction of time-dependent deformations of concrete, *Materials and Structures, Research and Testing* (RILEM, Paris), **11** (65), (1978), 307-28; **11** (66), (1978), 415-34; **11**(69),(1979), 169-83.
- [13.2] O. Ditlevsen and T. Arnbjerg-Nielsen (1989) Decision rules in re-evaluation of existing structures. *Proceedings of DABI Symposium on Re-evaluation of Concrete Structures*. (eds.: S. Rostam and M.W. Bræstrup). Danish Concrete Institute, 239-48.
- [13.3] H.O. Madsen and Z.P. Bazant (1983) Uncertainty analysis of creep and shrinkage effects in concrete structures. *American Concrete Institute Journal*, **80**.
- [13.4] H.O. Madsen (1985) Random fatigue crack growth and inspection. In *Structural Safety and Reliability*, Proceedings of ICOSSAR 85, Kobe, Japan, IASSAR, Vol.1, 475-84.
- [13.5] H.O. Madsen (1987) Model updating in reliability theory. In *Reliability and Risk Analysis in Civil Engineering*, Proceedings of ICASP 5, N.C.Lind (ed.), Institute for Risk Research, University of Waterloo, Vol.1, 564-77.
- [13.6] H.O. Madsen *et al.* (1987) Probabilistic fatigue crack growth analysis of offshore structures, with reliability updating through inspection. In *Proceedings of Marine Structural Reliability Symposium*, SNAME 54-23.
- [13.7] R. Rackwitz and K. Schrupp (1985) Quality control, proof testing and structural reliability. *Structural Safety*, **2**, 239-44.

This page is intentionally left blank.

Chapter 14

SYSTEM-RELIABILITY ANALYSIS

14.1 Series systems and parallel systems

System-reliability analysis concerns the formulation of the limit state and calculation of the failure probability when the structure has more ways of failing. Mathematically we encounter system reliability analysis if the limit-state surface is composed by more pieces that generally intersect pairwise in sets of singular points, which are points at which the limit-state surface is not differentiable. Each of these pieces will usually be a part of a limit-state surface for a specific global failure mode or for a local failure. An example of a local failure is rupture of a redundant structural element.

We have earlier considered systems for which the total failure event can be written as

$$\mathcal{F} = \bigcup_{i=1}^m \mathcal{F}_i \quad (14.1.1)$$

where \mathcal{F}_i is the failure event corresponding to the i th failure mode. Such systems are denoted as series systems. The most common example is a statically determinate structure composed of several elements. If just one of these elements fails, the structure loses its carrying capacity, Example 6.3. Another example is a frame structure made of a rigid-ideal plastic material. Each mechanism is then a possible failure mode, Example 6.4. A series system is also denoted as a “weakest link” system.

Earlier we have also considered systems for which the total failure event can be written as

$$\mathcal{F} = \bigcap_{i=1}^m \mathcal{F}_i \quad (14.1.2)$$

Here all elements must fail in order for total failure to occur. Such systems are denoted as parallel systems and they most often appear as elements in a series system. For a statically indeterminate structure with several failure modes several of the single failure modes do not occur unless several structural elements have failed. For example, in a statically indeterminate rigid-ideal-plastic frame structure several yield hinges must be generated before a mechanism can develop.

14.2 General systems. Cut sets and tie sets*

Series systems and parallel systems are the two basic system types from which any system can be built. Any system can be represented both as a series system of parallel systems and as a parallel system of series systems. To see this we assume that there are m different potential local failure modes that in specific combinations cause total failure. We can then divide all of \mathbb{R}^n into the 2^m disjoint subsets

$$\mathcal{F}_{i_1} \cap \mathcal{F}_{i_2} \cap \dots \cap \mathcal{F}_{i_k} \cap \mathcal{S}_{i_{k+1}} \cap \dots \cap \mathcal{S}_{i_m} \quad (14.2.1)$$

where $k = 0, 1, \dots, m$ and i_1, \dots, i_k are k different indices chosen among $1, 2, \dots, m$ and i_{k+1}, \dots, i_m are the remaining indices. The total failure set \mathcal{F} is the union of all the sets among the sets (14.2.1) that correspond to total failure. We will use the property that if (14.2.1) is a subset of the total failure set, then any of the sets obtained by replacing one or more of the safe sets $\mathcal{S}_{i_{k+1}}, \dots, \mathcal{S}_{i_m}$ by the corresponding failure sets among $\mathcal{F}_{i_{k+1}}, \dots, \mathcal{F}_{i_m}$ are also subsets of the total failure set. This is because a failed system does not change to a safe state if even more elements fail. By taking the union of all these sets the set $\mathcal{F}_{i_1} \cap \dots \cap \mathcal{F}_{i_k}$ is obtained. Thus we have that

$$\mathcal{F} = \bigcup (\mathcal{F}_{i_1} \cap \dots \cap \mathcal{F}_{i_k}) \quad (14.2.2)$$

where the union is taken over all intersections of the form $\mathcal{F}_{i_1} \cap \dots \cap \mathcal{F}_{i_k}$ that are subsets of \mathcal{F} . By this the system is represented as a series system of parallel systems. It is seen that the intersections in (14.2.2) are not necessarily disjoint. We can take a step more and replace each of these intersections by an intersection $\mathcal{F}_{j_1} \cap \dots \cap \mathcal{F}_{j_q}$ that satisfies the condition

$$\mathcal{F} \supset \mathcal{F}_{j_1} \cap \dots \cap \mathcal{F}_{j_q} \supset \mathcal{F}_{i_1} \cap \dots \cap \mathcal{F}_{i_k} \quad (14.2.3)$$

where $q \leq k$ and $\{j_1, \dots, j_q\} \subset \{i_1, \dots, i_k\}$. Each such index set $\{j_1, \dots, j_q\}$ is called a *cut set*. In particular we can choose q as the smallest number for which (14.2.3) is valid. The index set $\{j_1, \dots, j_q\}$ is then said to be a *minimal cut set*. Thus we can write (14.2.2) as

$$\mathcal{F} = \bigcup_{\text{mc}} (\mathcal{F}_{j_1} \cap \dots \cap \mathcal{F}_{j_q}) \quad (14.2.4)$$

where mc indicates that the union is taken over the set of minimal cut sets among the subsets of $\{1, \dots, m\}$.

The safe set \mathcal{S} with respect to total failure is the complementary set to the total failure set \mathcal{F} and \mathcal{S} is the union of all the sets among the sets in (14.2.1) that do not correspond to failure. We can now state exactly the same arguments that led to (14.2.2), (14.2.3) and (14.2.4) but with the symbol \mathcal{F} replaced in all expressions by the symbol \mathcal{S} and vice versa and with the words "total failure set" replaced everywhere with the words "safe set with respect to total failure" and vice versa. In particular the sentence just before (14.2.2) should read: "an unfailed system does not fail when one or more elements are changed from the failed state to the unfailed state".

Corresponding to (14.2.2) we thus get that

$$\mathcal{S} = \bigcup (\mathcal{S}_{i_1} \cap \dots \cap \mathcal{S}_{i_k}) \quad (14.2.5)$$

which in terms of the complementary sets is equivalent to (Morgan’s rule):

$$\mathcal{F} = \bigcap (\mathcal{F}_{i_1} \cup \dots \cup \mathcal{F}_{i_k}) \tag{14.2.6}$$

This shows that the system can be represented also as a parallel system of series systems. We can make a further reduction of (14.2.6) corresponding to the reduction from (14.2.2) to (14.2.4). With \mathcal{S} in place of \mathcal{F} in (14.2.3) we get

$$\mathcal{S} \supset \mathcal{S}_{j_1} \cap \dots \cap \mathcal{S}_{j_q} \supset \mathcal{S}_{i_1} \cap \dots \cap \mathcal{S}_{i_k} \tag{14.2.7}$$

where $q \leq k$ and $\{j_1, \dots, j_q\} \subset \{i_1, \dots, i_k\}$. Each such index set $\{j_1, \dots, j_q\}$ is called a *tie set*. In particular we can choose q as the smallest number for which (14.2.7) is valid. The index set $\{j_1, \dots, j_q\}$ is then said to be a *minimal tie set*. Thus (14.2.6) can be reduced to

$$\mathcal{F} = \bigcap_{\text{mt}} (\mathcal{F}_{j_1} \cup \dots \cup \mathcal{F}_{j_q}) \tag{14.2.8}$$

where mt indicates that the intersection is taken over the set of minimal tie sets among the subsets of $\{1, \dots, m\}$.

It is emphasized that the index sets $\{j_1, \dots, j_q\}$ are different in (14.2.4) and in (14.2.8). The terminologies “cut set” and “tie set” are loan-words from the theory of electrical systems. Failure of the system corresponds to a situation where all connections are cut while functioning of the system corresponds to a situation where at least one of the connections works.

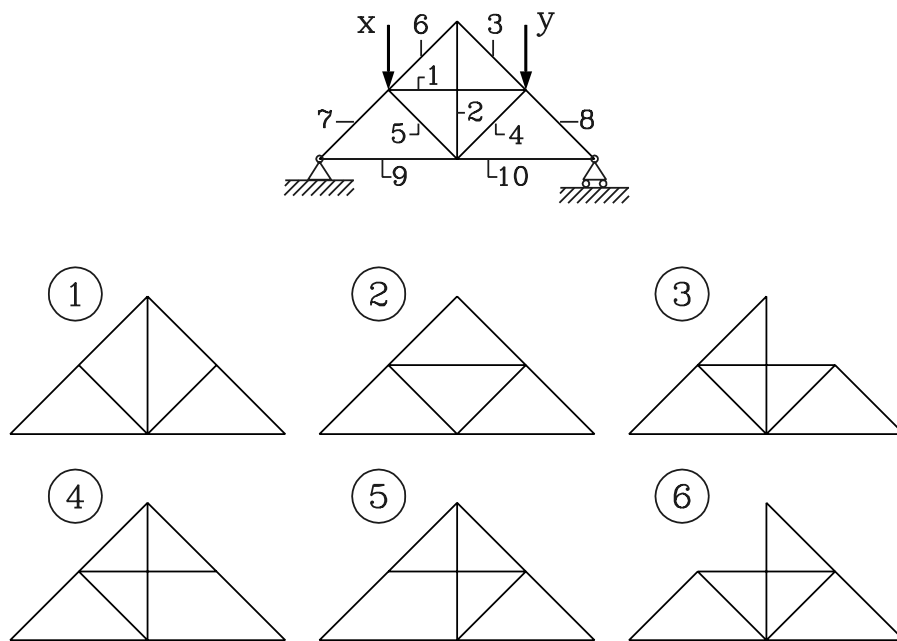

Figure 14.1: Geometrically one degree overdeterminate truss structure and the corresponding six geometrically determinate truss structures that correspond to the six minimal tie sets that preserve geometric determinacy.

Example 14.1 Figure 14.1 shows a truss structure with crossing diagonals 1 and 2. The structure is one degree geometrically overdeterminate (\sim one degree statically indeterminate). By removal of one of the bars 1, 2, 3, 4, 5, 6 a geometrically determinate (i.e. statically determinate) structure is obtained.

The corresponding six geometrically determinate truss systems are also shown in Fig. 14.1. Removal of one more bar will cause that the structure becomes geometrically underdeterminate, which is the same as saying that it becomes movable. Thus there are in total 6 minimal tie sets:

$$\begin{aligned}
 &\{2, 3, 4, 5, 6; 7, 8, 9, 10\} \\
 &\{1, 3, 4, 5, 6; 7, 8, 9, 10\} \\
 &\{1, 2, 4, 5, 6; 7, 8, 9, 10\} \\
 &\{1, 2, 3, 5, 6; 7, 8, 9, 10\} \\
 &\{1, 2, 3, 4, 6; 7, 8, 9, 10\} \\
 &\{1, 2, 3, 4, 5; 7, 8, 9, 10\}
 \end{aligned} \tag{14.2.9}$$

These minimal tie sets represent the truss system with respect to geometric determinacy as a parallel system with six parallel elements. Each of these elements is a series system with nine elements.

A cut set with respect to geometric determinacy is obtained by choosing one and only one element from each of the minimal tie sets. Since the bar numbers 7, 8, 9, 10 are contained in all the minimal tie sets, we get the four minimal cut sets $\{7\}$, $\{8\}$, $\{9\}$, $\{10\}$ with only one element in each set. Each of the remaining six bar numbers 1, 2, 3, 4, 5, 6 is contained in five of the six minimal tie sets. All other minimal cut sets thus have two elements and they appear in identical pairs where each of the six bar numbers is taken together with each of the five remaining bar numbers. Thus there are $5 \times 6/2 = 15$ minimal cut sets with two bar numbers in each:

$$\begin{aligned}
 &\{1, 2\}, \{1, 3\}, \{1, 4\}, \{1, 5\}, \{1, 6\} \\
 &\{2, 3\}, \{2, 4\}, \{2, 5\}, \{2, 6\} \\
 &\{3, 4\}, \{3, 5\}, \{3, 6\}, \{4, 5\}, \{4, 6\}, \{5, 6\}
 \end{aligned} \tag{14.2.10}$$

These in total nineteen minimal cut sets represent the truss system as a series system with nineteen elements of which the fifteen elements are parallel systems with two parallel elements. \square

Remark 14.1 In Example 14.1 no considerations were made concerning failure or no failure of the individual truss bars in dependence of their strengths and the external loads on the truss structure. The concern was solely about system failure defined as the occurrence of geometric underdeterminacy. Even though considerations about this can be useful in connection with the statical analysis, they are less relevant for the reliability analysis.

For example, if all truss bars are linear elastic and ideal brittle (a bar is said to be ideal brittle if the internal force in the bar drops abruptly to zero when it reaches the strength of the bar), it will depend on the load history which bar is the first to fail. There can even be such a distribution of bar stiffnesses and bar strengths in the truss in Fig. 14.1 that it will be bar 1 that fails first irrespective of how the loads x and y varies within the positive domain. After failure of bar 1 the internal forces redistribute immediately to the statically determinate solution corresponding to system 1. The strengths of the bars 2-6 can, however, be such that the internal forces after redistribution are larger than the strengths of one or more of the bars. If so the truss structure suffers total failure

by the redistribution of the internal forces. None of the tie sets formulated in Example 14.1 have in such a case any relevance with respect to reliability. It is solely the bar 1 that determines the reliability of the system.

Linear elastic structural systems with ideal brittle failure elements will be reconsidered in Section 14.5. \square

14.3 Influence on the definition of the limit state of the time variation of the input variables

The truss structure example (Remark 14.1) indicates that considerable difficulties can appear when it comes to the mathematical formulation of the limit state for a structural system. These difficulties appear in particular when the limit state is defined such that it corresponds to loss of the bearing capacity of the structure after previous successive deterioration of the structure by failure of statically redundant parts.

The successive deterioration depends on circumstances that are not uniquely fixed by the mere specification of the outcome of the random input vector $\mathbf{X} = (X_1, \dots, X_n)$. In the previous chapters problems of this type have not been considered. In fact, the problem of how X_1, \dots, X_n physically get assigned their values when the structure is realized has simply not been addressed. The detailed development of the load history can, however, have a decisive influence on the definition of the limit state.

The real structure is incomplete during a period of construction. In this period the input variables have changing values. After finishing the structure and bringing it into service, the loads on the structure change systematically and/or randomly throughout the entire service life. In the different states of completion and use the structure can naturally be analyzed with respect to reliability by the described methods. These methods only require that a safe set $\mathcal{S} \subset \mathbb{R}^n$ is defined and that a probability distribution for \mathbf{X} is defined. Besides the modeling of these objects the reliability analysis consists in calculating the probability that $\mathbf{X} \in \mathcal{S}$. By use of a comparison standard it is thereafter evaluated whether the structure is sufficiently reliable.

The reliability analysis can be formulated without introduction of new concepts in such a way that it embraces all the resistance and action situations as they develop systematically or randomly through a sequence of initially specified time points t_1, t_2, \dots, t_m chosen in the construction period and in the service period. The reliability of the structure hereby is evaluated on the basis of the probability of the event

$$\{\mathbf{X}(t_1) \in \mathcal{S}(t_1)\} \cap \dots \cap \{\mathbf{X}(t_m) \in \mathcal{S}(t_m)\} \quad (14.3.1)$$

where $\mathbf{X}(t_i)$ is the random vector of input variables to the time t_i and $\mathcal{S}(t_i) \subset \mathbb{R}^n$ is the safe set corresponding to the time t_i . In several situations the safe sets $\mathcal{S}(t_1), \dots, \mathcal{S}(t_m)$ can be defined independently of the outcomes of $\mathbf{X}(t_1), \dots, \mathbf{X}(t_m)$. Having formulated a probability distribution for the $n \times m$ -dimensional random vector $(\mathbf{X}(t_1), \dots, \mathbf{X}(t_m))$ it is then the probability content of the safe set $\mathcal{S}(t_1) \times \dots \times \mathcal{S}(t_m)$ that should be calculated. In the previous chapters we have several times seen examples of this special case. These are the examples with independent replacements of loads.

The FBC load model in Chapter 10 is directly formulated with this special temporal treatment in mind. In these simple applications the safe set has been constant in time and an obvious definition has existed of an extreme scalar load effect corresponding to the considered time period.

The problem becomes considerably more difficult if the safe set $\mathcal{S}(t)$ in its development in time is dependent on the previous development of the outcome of the input vector $\mathbf{X}(t)$. Let us consider a statically indeterminate truss structure where the bars, including the connections, behave linearly elastic up to a strength value that varies randomly from bar to bar and differently for tension and compression. The truss structure is assumed to be subject to a set of random loads that increase proportionally from zero to the final random values drawn from the given distribution. This load history is controlled by use of a scalar load level factor λ that increases from 0 to 1. A calculation based on the elasticity theory determines uniquely the internal forces in all bars as functions of λ . If λ can reach the value 1 without the occurrence of failure in any bar, the vector of input variables is a point in the safe set, of course. However, it may happen that one or more redundant bars fail before λ reaches the value 1 but simultaneously that the structure with these redundant bars removed has internal forces that are all below the respective strengths. This means that the damaged structure can still carry the load, so if this property is the verbally formulated limit-state requirement, then the vector of input variables is also a point in the safe set in this situation.

Under the assumption of proportional loading we thus get a well defined limit-state surface in the space of input variables. The surface can be extremely complicated because it depends on the succession of failures of the redundant bars. This succession depends on the redistribution of the internal forces that takes place after each bar failure. Each bar failure may even trigger a cascade of bar failures. The succession of the bar failures in the cascade determines the final state of the structure after the end of the cascade.

If there are load histories that are not uniquely determined by the set of input variables \mathbf{X} , the limit state surface in the \mathbf{x} -space is not necessarily uniquely determined. Such ambiguity can be considered as model uncertainty. Due to the complicated nature of the problem it is not easy to use theoretical considerations to quantify this model uncertainty in order to formulate a representation using the principles of Chapter 3.

When formulated in the space that corresponds to the input variables associated to all the chosen discrete time points, the ambiguity of the limit state surface comes from the unspecified variation of the input variables between the chosen time points. A consistent extension of the time-discrete model by including more time points will give a larger failure probability because a finer discretization cannot lead to a decrease of the set of failure possibilities. The discretization effect of underestimating the failure probability can be overcome by use of the theory of random processes. In principle this theory makes it possible to formulate a reliability analysis which do not necessitate a discretization of the time and the space. Unfortunately such process-based reliability analysis gives only few possibilities of exact determination of the failure probability even in the simplest examples. However, the process theory leads to a general formulation of a useful upper bound of the failure probability. The random process theory will be given an introductory treatment in Chapter 15.

14.4 "Jury definitions" of the safe set

The difficulties of including the influence of the load history on the definition of the safe set show up in the literature on reliability analysis of general structural systems by different often not very clear suggestions of "jury definitions". This (home made) terminology is introduced here because the time variations are either not considered or, when it is claimed to be considered, then often on the basis of vague arguments that aim a convincing the reader that the defined safe set by and large corresponds to proportional loading from zero.

The most commonly seen system-failure definitions are of a type given implicitly through a calculational scheme (an algorithm) which contains a failure-sequence concept that, without any tenable basis, is claimed to mirror proportional growth of the loads. The following jury definition seems to be used in many system-reliability algorithms.

Assume that there are q potential failure elements in the structure and consider the $q!$ different ordered sets of failure elements. To each of these ordered sets there corresponds an ordered set of structural models. These models represent successively reduced fragments of the original structure in the sense that each model of the ordered set has exactly one failed element more than its direct predecessor.

Let now \mathbf{x} be a value of the input vector and focus on any one of the ordered sets S of failure elements. First the basis model is considered, that is, the model of the undamaged structure. It is assumed to be linear-elastic. Thus the state of the structure is completely defined by \mathbf{x} . If there is a stable state of equilibrium and the limit state is not passed for the first failure element of the considered ordered set S of failure elements, then the structure for the given \mathbf{x} is said to be statically stable in S . If not, we change the linear-elastic properties of the first failure element in S to the constitutive post-failure properties. Often these properties are simulated simply by replacing the failed element by a system of "equivalent" external forces with fixed values that correspond to the residual carrying capacity of the failed element (zero for ideal brittle failure, the yield strength for ideal plastic failure). A statical analysis is next made for this first model in the ordered set of models corresponding to the sequence S . If there is a stable state of equilibrium and the limit state for the second failure element in the sequence S is not passed, then the structure for the given \mathbf{x} is said to be statically stable in S . If not, the second failure element is changed following the same principles as for the first failure element. This defines the second model in the ordered set of models corresponding to S whereafter the statical calculation is carried through as for the first model. Recursive calculation and modeling in this way reveals either that the structure for the given \mathbf{x} is statically stable in S or that one of the models in the ordered sequence shows statical instability. Of course, at the latest this occurs for the q th model.

On the basis of this model formulation the following jury definition of the safe set can be made: The point \mathbf{x} is said to belong to the safe set for the structure if and only if the structure corresponding to \mathbf{x} is statically stable in all the $q!$ different ordered sets of failure elements. The set defined in this way will be denoted as the *sequential stable-configuration set*. It is a subset, and often a genuine subset, of the union of the safe sets with respect to the terminal load for all substructures that are not movable. This union will be denoted as the *stable-configuration set*. For the truss structure in Example 14.1 the stable-configuration set is the same as the union of the safe set with respect to first bar failure and the six safe sets that corresponds to the six statically

determinate substructures.

Example 14.2 Figure 14.2 shows a simple linear-elastic frame structure with the indicated beam stiffnesses and with two potential failure elements concentrated at the points 1 and 2. The failure elements are ideal brittle with moment strengths $\pm M$ at point 1 and $\pm 2M/3$ at point 2. After failure the points are changed to moment-free points (hinges). The example (taken from [14.4,9]) is well suited for illustration of the influence of the load history on the safe set. Moreover, it is a counter example to the intuitive claim that the sequential stable-configuration set corresponds to proportional loading.

The bending moments of the intact failure elements are shown on the frame structure at the top and to the right. Next row of drawings shows the bending moments after failure at point 1 and point 2, respectively. The following three (x, y) -coordinate systems show the safe sets corresponding to the load paths indicated as arrows. In all three cases the two limit states are shown for each of the two failure elements before and after the first failure either at point 1 or at point 2. The failure set in the first coordinate system corresponds to the situation where S_1 is applied first to its final value, after which S_2 is applied to its final value. In the second coordinate system, S_2 is applied first to its final value, whereafter S_1 is applied. In the third coordinate system, S_1 and S_2 are applied simultaneously by proportional loading from zero. All three safe sets are seen to be genuine subsets of the stable-configuration set. Indeed, due to its definition the stable-configuration set is equal to the union $\{3 - 3x - 5y > 0, 2 - 3x + 3y > 0\} \cup \{y < \frac{27}{64}\} \cup \{y < \frac{18}{64}\} = \{3 - 3x - 5y > 0, y < \frac{27}{64}\}$. This set is bounded by the limit state lines corresponding to point 1. For brevity we have used the notation $\{\text{statement}\}$ for the set $\{(x, y) \mid \text{statement}\}$.

To determine the sequential stable-configuration set we consider the complete set of ordered sets $\{1,2\}$ and $\{2,1\}$ of failure elements. The sets of points (x, y) for which the structure is statically stable in the ordered set $\{1,2\}$ and $\{2,1\}$ of element failures, respectively, are $\{3 - 3x - 5y > 0\} \cup \{y < \frac{18}{64}\}$ and $\{2 - 3x + 3y > 0\} \cup \{y < \frac{27}{64}\}$. It is seen that first set is a genuine subset of the second set. The intersection of the two sets is the sequential stable-configuration set and thus it is the first of the two sets, which is identical to the safe set shown in the second coordinate system. It is different from the safe set that corresponds to proportional loading. It has been claimed [14.4] that the sequential stable-configuration set is a subset of any safe set that has been defined under due considerations of the load path. For this statement to be true it is necessary to introduce some restrictions on the set of possible load paths. In this example it is only needed to choose a piecewise axis parallel load path as $(x, y) = (0, 0) \rightarrow (0.9, 0) \rightarrow (0.9, 0.1) \rightarrow (0.1, 0.1) \rightarrow (0.1, 0.5)$ to generate a total failure. This load path is seen to be completely contained in the sequential stable-configuration set. \square

14.5 Ideal-plastic systems and ideal-brittle systems*

The definition of the sequential stable-configuration set appeals intuitively to be used as a jury definition of the safe set. However, as shown in Example 14.2, a clear physical interpretation is missing of this jury definition in relation to given specifications of the load path. Except for two special idealized cases it seems difficult to characterize the sequential stable-configuration set as either embracing or being contained in a safe set defined in a physically interpretable way in relation to an extended model that includes load-path specifications.

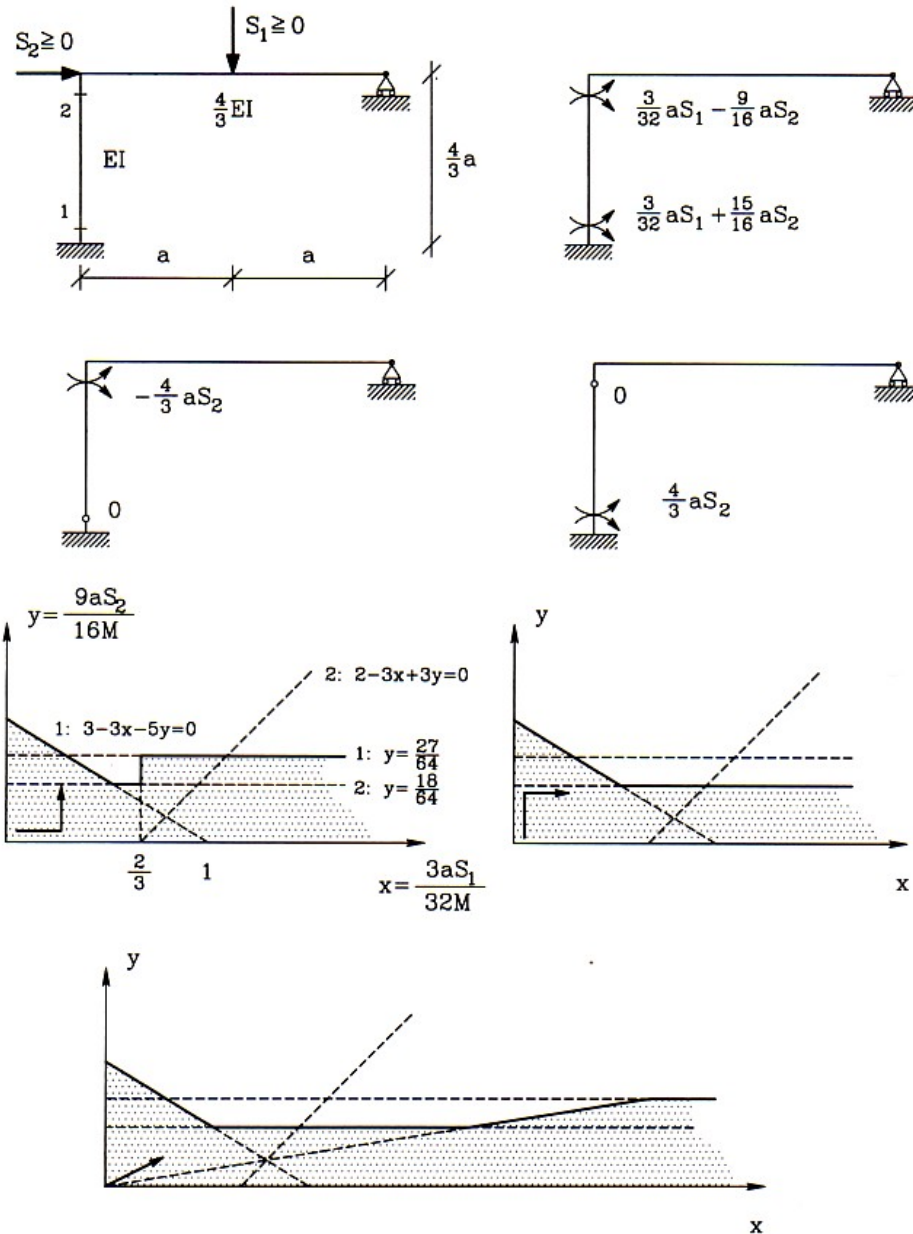

Figure 14.2: Illustration of the influence of the load path on the definition of the safe set for a linear-elastic-ideal-brittle frame structure.

The one idealized case is a structure with rigid-ideal-plastic failure elements. Under the assumption of the associated flow rule (the normality condition) the stable-configuration set becomes identical to the safe set defined under the assumption of proportional loading from zero. This is a consequence of the lower-bound theorem of the plasticity theory: if and only if there exists a state of internal stresses which is in equilibrium with the external system of forces and which in all failure elements is inside or on the yield surface, then the structure is safe with respect to

collapse. If the normality condition is dropped, the theorem cannot be maintained as a sufficient condition that there is no collapse. Then it can only be claimed that the safe set is a subset of the stable-configuration set.

With the normality condition maintained the assumption of proportional loading can be relaxed to a much larger class of load paths. A discussion of this requires some few concepts from the theory of random vector processes. The problem will be treated in the next chapter. The implied load-path independence in the sense as explained in the next chapter makes it attractive to try to apply the ideal plasticity theory on structures with ductile behavior at failure even though the premises of the theory are not valid in all details for the real structure. The obtained simplification of the mechanical modeling must be paid, naturally, by the introduction of suitable model uncertainty variables.

The other ideal case is a linear-elastic structure with ideal-brittle failure elements. In the following let \mathbf{X} denote the terminal load solely. All the remaining not explicitly shown input variables are assumed to have constant values throughout time. Assume that the structure is subject to proportional loading, that is, assume that the load changes along a load path $L(\mathbf{X})$ from zero to the terminal load point \mathbf{X} where $L(\mathbf{X})$ defines a straight line in the space of \mathbf{X} . Either no element will fail before \mathbf{X} is reached or there will be a first element that fails. By this failure a redistribution of the internal forces of the structure will take place. Assuming that dynamic effects of the failure can be neglected, a statical analysis will show whether the structure can resist the redistributed internal forces or whether other failure elements will be stressed over their strengths immediately upon the first failure. In the last case the first failure triggers another element failure or even a cascade of element failures. Along the load path we may thus have either no failure, a sequence of single failures or a sequence of failures of which some or all occur in cascades. The load path terminates at a point that either corresponds to a safe state of the structure, that is, to a point of \mathcal{S} , or at a point that corresponds to loss of the carrying ability of the structure, that is, at a point of \mathcal{F} .

To be able to keep track of the succession of element failures in a cascade failure solely by statical calculations it is necessary to introduce a jury hypothesis that fix the succession of failures. For simplicity, but sufficiently general, consider the situation where the elements fail according to the applied jury hypothesis in the order of their numeration. In case the elements $1, 2, \dots, i$ are removed from the structure and the remaining structural configuration defines a system which is not movable, we can define the $q - i$ safety margins

$$M_{i+1}^{12\dots i}, \dots, M_q^{12\dots i} \quad (14.5.1)$$

as functions of the actual load \mathbf{x} . For $i = 0$ we get the safety margins for the failure elements of the original undamaged structure. During the load growth from the zero load point along the load path $L(\mathbf{X})$ these safety margins M_1^0, \dots, M_q^0 have initial values that are all in the positive domain. The event

$$L(\mathbf{X}) \subset S^0 = \{\mathbf{x} | M_1^0 > 0, \dots, M_q^0 > 0\} \quad (14.5.2)$$

will be denoted as the safe basis event. Obviously this event does not occur if the load path $L(\mathbf{X})$ has points in common with the set

$$F_1^0 = \{\mathbf{x} | M_1^0 \leq 0, M_2^0 > 0, \dots, M_q^0 > 0\} \quad (14.5.3)$$

since the load then reaches a point A on the load path where $M_1^0 = 0$ and $M_2^0 > 0, \dots, M_q^0 > 0$. At this point A, element 1 fails whereafter the safety margins M_2^1, \dots, M_q^1 become actual for the analysis of the behavior of the structure. If two or more of these new safety margins are zero or negative at A, a cascade of element failures occurs. Then we have a situation where it is undetermined which element fails first when solely statical calculations are made. Therefore we introduce the jury hypothesis that if the load path $L(\mathbf{X})$ has points in common with the set

$$F_2^1 = \{\mathbf{x} | M_2^1 \leq 0, M_3^1 > 0, \dots, M_q^1 > 0\} \quad (14.5.4)$$

then the element 2 is the first failure element in the cascade. The hypothesis gives a unique answer because all the safety margins vary linearly along the load path and all are positive at the zero load point. Consequently this hypothesis states that if the structure in which element 1 is missing is loaded from the zero load point along $L(\mathbf{X})$ and it by this loading is element 2 that fails first, then it is also element 2 that fails first in the actual structure as a consequence of the redistribution of the internal forces released by the failure of element 1. The principle of the hypothesis can without change be applied during the further load development. If $L(\mathbf{X})$ has points in common with the set

$$F_3^{12} = \{\mathbf{x} | M_3^{12} \leq 0, M_4^{12} > 0, \dots, M_q^{12} > 0\} \quad (14.5.5)$$

the hypothesis states that element 3 is the next element that fails either within the first cascade of failures or as a single failure or as the first failure of a new cascade of failures.

On the basis of the failure order specified in this way we thus see that the safe failure sequence $\{1, 2, \dots, i\}$ occurs if and only if the structure obtained by the removal of elements $1, \dots, i$ is not movable and that both the events

$$L(\mathbf{X}) \cap F_j^{12\dots(j-1)} \neq \emptyset, \quad j = 1, \dots, i \quad (14.5.6)$$

and the event

$$\mathbf{X} \in S^{12\dots i} \neq \emptyset \quad (14.5.7)$$

occur. The symbol \emptyset denotes the empty event and

$$F_j^{12\dots(j-1)} = \{\mathbf{x} | M_j^{12\dots(j-1)} \leq 0, M_{j+1}^{12\dots(j-1)} > 0, \dots, M_q^{12\dots(j-1)} > 0\} \quad (14.5.8)$$

$$S^{12\dots i} = \{\mathbf{x} | M_{i+1}^{12\dots i} > 0, \dots, M_q^{12\dots i} > 0\} \quad (14.5.9)$$

We have denoted the failure sequence $\{1, 2, \dots, i\}$ as a safe failure sequence because the load path $L(\mathbf{X})$ terminates at a point \mathbf{X} for which the structure is not totally failed.

The event

$$\mathbf{X} \in S^{12\dots i} \cap \left(\bigcap_{j=1}^i F_j^{12\dots(j-1)} \right) \quad (14.5.10)$$

obviously implies that the safe failure sequence $\{1, 2, \dots, i\}$ occurs. Therefore the probability

$$\begin{aligned} & P(M_1^0 \leq 0, M_2^0 > 0, \dots, M_q^0 > 0, \\ & M_2^1 \leq 0, M_3^1 > 0, \dots, M_q^1 > 0, \dots, \\ & M_i^{12\dots(i-1)} \leq 0, M_{i+1}^{12\dots(i-1)} > 0, \dots, M_q^{12\dots(i-1)} > 0, \\ & M_{i+1}^{12\dots i} > 0, \dots, M_q^{12\dots i} > 0) \end{aligned} \quad (14.5.11)$$

is a lower bound on the probability that the safe failure sequence $\{1, 2, \dots, i\}$ occurs.

This probability can be calculated approximately by use of single-point or multi-point FORM or SORM, see Section 6.6. If the set of all safety margins appearing in (14.5.11) is jointly Gaussian, the probability is given by the possibly singular m -dimensional normal distribution function

$$\begin{aligned} & \Phi_m(-\beta_1^0, \beta_2^0, \dots, \beta_q^0, \\ & -\beta_2^1, \beta_3^1, \dots, \beta_q^1, \dots, \\ & -\beta_i^{12\dots(i-1)}, \beta_{i+1}^{12\dots(i-1)}, \dots, \beta_q^{12\dots(i-1)}, \\ & \beta_{i+1}^{12\dots i}, \dots, \beta_q^{12\dots i}, \mathbf{P}_M) \end{aligned} \quad (14.5.12)$$

where $m = q + (q - 1) + \dots + (q - i) = (i + 1)(q - i/2)$. The matrix \mathbf{P}_M is the correlation matrix for the vector \mathbf{M} of m safety margins and $\beta_1^0, \dots, \beta_q^{12\dots i}$ are the corresponding reliability indices.

The safe failure sequences are disjoint events. The probability of the safe event is therefore the sum of the probability of the safe basis event and the probabilities of all the safe failure sequences. Except for very simple structures it is not practicable to include all the safe failure sequences in the reliability evaluation.

Of course, by only including some of the events (14.5.15) we get a lower bound evaluation. We will not discuss here systematic search methods for the identification of the safe failure sequences that give essential contributions to the sum. However, it should be noted that there is a simple way of deciding whether a given safe failure sequence contributes negligible relative to the contributions of other safe failure sequences. For this purpose an upper bound evaluation is needed. Such an evaluation can be constructed by use of the fact that the occurrence of the events (14.5.6) implies the occurrence of the events

$$L(\mathbf{X}) \cap \{\mathbf{x} | M_j^{12\dots(j-1)} \leq 0\} \neq \emptyset, \quad j = 1, \dots, i \quad (14.5.13)$$

Since the safety margin $M_j^{12\dots(j-1)}$ is negative for $\mathbf{x} = \mathbf{X}$ if it is negative at a point of the load path $L(\mathbf{X})$, it is seen that the events (14.5.13) are the same as the events

$$\mathbf{X} \in \{\mathbf{x} | M_j^{12\dots(j-1)} \leq 0\}, \quad j = 1, \dots, i \quad (14.5.14)$$

Thus we have that the probability

$$\begin{aligned} & P(M_1^0 \leq 0, M_2^1 \leq 0, M_i^{12\dots i} \leq 0, M_{i+1}^{12\dots i} > 0, \dots, M_q^{12\dots i} > 0) \\ & \leq \sum_{j=1}^i P(M_j^{12\dots(j-1)} \leq 0) + \sum_{j=i+1}^q P(M_j^{12\dots i} > 0) \end{aligned} \quad (14.5.15)$$

is an upper bound of the probability that the safe failure sequence $\{1, 2, \dots, i\}$ occurs.

A non-safe failure sequence $\{1, 2, \dots, i\}$ is characterized by the property that the structure is movable after the failure of the first i failure elements but still is not movable when solely the first $i - 1$ failure elements have failed. This non-safe failure sequence occurs only if the events (14.5.6) occur. If the last row of inequalities $M_{i+1}^{12\dots i} > 0, \dots, M_q^{12\dots i} > 0$ are removed in (14.5.11) we get a lower bound on the probability that the non-safe failure sequence $\{1, 2, \dots, i\}$ occurs. Since

the non-safe failure sequences just as the safe failure sequences are mutually disjoint, any sum of such lower bounds becomes a lower bound on the total failure probability. The relative importance of the different non-safe failure sequences can be judged by an evaluation as in (14.5.15) after removal of the last sum with the terms $P(M_j^{12\dots i} > 0)$.

It appears from this discussion that even for the considered very idealized structural type subject to proportional loading from zero it is quite complicated to formulate the safe set and to calculate the corresponding probability. It is noted that the events (14.5.14) are the events that are considered in the definition of the sequential stable-configuration set in Section 14.4. The safe set given by the union of the safe basis event and all the sets that correspond to the safe failure sequences is then a subset of the sequential stable-configuration set. The probability of the event defined by the sequential stable-configuration set therefore overestimates the reliability with respect to total failure.

14.6 Historical and bibliographical notes

There is a general theory for systems of components where failure of one or more components of the system does not change the action conditions for the remaining not failed components, or at least only does it in a very simple way. This theory is today a well-developed tool for the reliability analysis of electrical apparatus systems or similar systems. The concepts of cut sets and tie sets come from this theory. Among the contributors to the development of what today could be characterized as classical theories of system reliability we will here mention R.E. Barlow and F. Proschan for their books from 1965 and 1975 [14.2,3].

When it concerns reliability analysis of structural systems the problem becomes of a much more complicated type than dealt with in the classical theory of system reliability. This is caused both by the influence of the load-path history and the complicated redistribution of the load effects after each component failure. The development trends are described in 1985 by G.I. Schuëller [14.10]. He tends to require realism in the details of the system reliability analysis to a degree that can be somewhat relaxed, perhaps. The difficulties of the system reliability analysis have been pointed out by C.A. Cornell in 1982 [14.6]. Supported by the extremely fast development of the technical means of calculation it seems as if formal calculational methods for system reliability analysis has developed ahead of the development of logically healthy and transparent mechanical and probabilistic principles. The discussion given in Section 14.4 about jury definitions of the safe set is thus a reaction of O. Ditlevsen presented the first time in 1987 [14.8,9].

There are too many contributors to the development of the formal calculational methods of reliability analysis of general so-called realistic structural systems for it to be feasible to give references to them all. Instead reference is made to a state-of-the-art paper by O. Ditlevsen and P. Bjerager from 1986 [14.7].

Transparent reliability analysis of rigid-ideal-plastic structures using both the upper-bound theorem and the lower-bound theorem of the plasticity theory was published first by G. Augusti and A. Baratta in 1972 [14.1]. Most contributions to the topic are based solely on the upper-bound theorem, that is, on the identification of collapse mechanisms. References are given in [14.7].

The upper and lower bounds for ideal-brittle structures under proportional loading are given by

P. Bjerager in 1984 [14.5].

Bibliography

- [14.1] G. Augusti and A. Baratta (1972) Limit analysis of structures with stochastic strengths variations. *Journal of Structural Mechanics*, **1**, 43-62.
- [14.2] R.E. Barlow and F. Proschan (1965) *Mathematical Theory of Reliability*, John Wiley, New York.
- [14.3] R.E. Barlow and F. Proschan (1975) *Statistical Theory of Reliability and Life Testing*. Holt, Reinhart and Winston, New York.
- [14.4] R.M. Bennett and A.H.-S. Ang (1986) Formulations of structural system reliability. *Journal of Eng. Mech.*, ASCE, **112**, 1135-51.
- [14.5] P. Bjerager (1984) *Reliability Analysis of Structural Systems*. Thesis, Report No. 183, Department of Structural Engineering, Technical University of Denmark, Lyngby, Denmark.
- [14.6] C.A. Cornell (1982) Some thoughts on system and structural reliability. *Nucl. Eng. & Des.*, **71**,195-229.
- [14.7] O. Ditlevsen and P. Bjerager (1986) Methods of structural systems reliability. *Structural Safety*, **3**,345-48.
- [14.8] O. Ditlevsen (1987) The structural system reliability problem. Qualitative considerations. *Reliability and Risk Analysis in Civil Engineering 1, ICASP 5*, (ed. N.C. Lind), Institute for Risk Research, Univ. of Waterloo, Waterloo, Ontario, Canada, pp. 1-11.
- [14.9] O. Ditlevsen (1988) Probabilistic statics of discretized ideal plastic frames. *Journal of Eng. Mech.*, **114**, 2093-114.
- [14.10] G.I. Schuëller (1985) Current trends in systems reliability. *Structural Safety and Reliability*, Vol.I (eds. I. Konishi, A.H-S. Ang and M. Shinozuka), Proc. ICOSSAR '85, Kobe, Japan, , pp. 139-148.

Chapter 15

INTRODUCTION TO PROCESS DESCRIPTIONS

15.1 Processes. Gaussian processes. Poisson processes

In several of the previous chapters we have encountered examples of simple modeling of random variations in time and space. The formal mathematical tools for such modeling are given in the theory of random processes or fields. In this chapter we will give an introduction to some few of the concepts and results that have relevance in the theory of structural reliability. The mathematical side of the presentation will be based on heuristic arguments. Attempts to maintain mathematical rigor will complicate the essentials with finer points that hardly are particularly useful for a reader that primarily is interested in the engineering applications.

A random process or a random field $X(t)$ is a family of random variables or vectors. Each member of the family is determined by a scalar or vectorial parameter t . For example, this parameter can be the time or it can be a position vector. An outcome (realization, sample function) $x(t)$ of the random process $X(t)$ is a function of the parameter t . For $t = t_0$ the value $x(t_0)$ is an outcome of the random variable $X(t_0)$. An example of an outcome is a specific load history from a weighted set of possible load histories. This weighted set is an example of a random process

The principles of the probabilistic description of a random process follow directly from the evident property that any chosen set of parameter values (t_1, \dots, t_n) defines a random vector $(X(t_1), \dots, X(t_n))$ which is described by an n -dimensional distribution in dependency of (t_1, \dots, t_n) . The probability structure of the process is fixed by assigning the set of all finite-dimensional probability distributions given that the assignment is made such that certain obvious requirements of consistency are satisfied.

One of the most often applied examples of such a consistent assignment of finite-dimensional distributions is the one that leads to the class of Gaussian processes. Assume that the mean value $E[X(t)]$ is assigned as a function $\mu(t)$ of t (the mean value function) and that the covariance $\text{Cov}[X(t_1), X(t_2)]$ is assigned as a function $c(t_1, t_2)$ of (t_1, t_2) (the covariance function). Then the mean value vector $\{E[X(t_i)]\}$ and the covariance matrix $\{\text{Cov}[X(t_i), X(t_j)]\}$ are determined for any choice of (t_1, \dots, t_n) . The assumption that the distribution of the vector $(X(t_1), \dots, X(t_n))$ is Gaussian then leads to a complete definition of a process. This process is called Gaussian with

mean value function $\mu(t)$ and covariance function $c(t_1, t_2)$. It is noted that the class of covariance functions must satisfy certain requirements that ensure that variances cannot be negative (the requirement is that the expectation functional must be positive). The requirements to $c(t_1, t_2)$ are that

$$c(t_1, t_2) = c(t_2, t_1) \quad (15.1.1)$$

and that

$$\sum_{i=1}^n \sum_{j=1}^n c(t_i, t_j) a_i a_j \geq 0 \quad (15.1.2)$$

for any n and any choice of t_1, \dots, t_n and arbitrary numbers a_1, \dots, a_n . If these two requirements are satisfied, the function $c(t_1, t_2)$ is said to be non-negative definite. The left side of (15.1.2) is just the variance of the linear combination $a_1 X(t_1) + \dots + a_n X(t_n)$.

For a Gaussian process with constant mean value function it is the properties of the covariance function (continuity, differentiability, behavior in the infinite, etc) that determine the properties of the sample functions. For example, we may talk about a Gaussian process with sample functions that are differentiable with continuous derivatives. This characterization is interpreted such that realizations without these properties only occur with zero probability. Concerning further details the reader should consult the literature on random processes.

Another fundamental example of a class of random processes is the class of Poisson processes. A Poisson process can be defined as a so-called counting process $N(t)$, $t \in \mathbb{R}_+$, that counts the number of certain uniquely defined incidents that occur at random in time. Thus the sample functions of $N(t)$ are ascending step functions with jumps of size 1 each time an incident occurs. The probability laws for a so-called homogeneous Poisson process are fixed by assigning the properties:

1. $N(t)$ has mutually independent increments, that is, for any $t_1 < t_2 \leq t_3 < t_4$ the random variables $N(t_2) - N(t_1)$ and $N(t_4) - N(t_3)$ are mutually independent,
2. the probability that a jump occurs in the interval $]t, t + \Delta t]$ is $c\Delta t +$ (terms of higher order in Δt) where c is a constant,
3. the probability that two or more jumps occur in the interval $]t, t + \Delta t]$ is of second or higher order in Δt .

These conditions uniquely lead to the probabilities

$$P[N(t + \tau) - N(t) = i] = e^{-c\tau} \frac{(c\tau)^i}{i!}, \quad i = 0, 1, \dots \quad (15.1.3)$$

If $N(0) = 0$ we get the n -dimensional distribution

$$P[N(t_1) = i_1, \dots, N(t_n) = i_n] = e^{-ct_n} c^{i_n} \frac{t_1^{i_1} (t_2 - t_1)^{i_2 - i_1} \dots (t_n - t_{n-1})^{i_n - i_{n-1}}}{i_1! (i_2 - i_1)! \dots (i_n - i_{n-1})!} \quad (15.1.4)$$

where $0 \leq t_1 \leq \dots \leq t_n$, $i_1 \leq i_2 \leq \dots \leq i_n$. The parameter c is called the intensity of the Poisson process. The right side of (15.1.3) is called a Poisson distribution with parameter $c\tau$.

We get an inhomogeneous Poisson process if c is a function of the time t . All what is needed is to change $c\tau$ in (15.1.3) to the integral $\int_t^{t+\tau} c(x) dx$ while (15.1.4) is modified correspondingly.

More generally, we can define a Poisson field over the q -dimensional space as a counting process $N(x_1, \dots, x_q)$ that counts the number of randomly positioned points (concentrated objects) with coordinates that each at most is x_1, \dots, x_q , respectively. Using completely analogous assignments of properties as for $N(t)$, it follows that the number of objects belonging to any given set V is distributed according to the Poisson distribution with its parameter equal to the integral of the intensity function $c(x_1, \dots, x_q)$ over V .

The class of Gaussian processes and the class of Poisson processes make up the building stones for quite many of the random processes that appear in the applications.

15.2 Upper bound of the failure probability

Let a possibly time-dependent safe set $\mathcal{S}(t)$ for a structure be given. The input vector $\mathbf{X}(t)$ is modeled as a random vector process such that failure within the time interval $[0, T]$ occurs if and only if there is some point in time $t \in [0, T]$ at which $\mathbf{X}(t) \in \mathcal{F}(t) = \complement \mathcal{S}(t)$. The safe set $\{\mathbf{X}(t) \in \mathcal{S}(t)$ for all $t \in [0, T]\}$ is obviously identical to the event

$$\{\mathbf{X}(0) \in \mathcal{S}(0)\} \cap \{N(T) = 0\} \quad (15.2.1)$$

where $N(T)$ is the number of outcrossings of $\mathbf{X}(t)$ out of $\mathcal{S}(t)$ in $[0, T]$. Loosely speaking, an outcrossing at time t is the event that $\mathbf{X}(t)$ at time t passes from $\mathcal{S}(t)$ to the complementary set $\mathcal{F}(t)$. This definition obviously makes sense if the sample functions of $\mathbf{X}(t)$ are continuous. However, a point at which $\mathbf{X}(t)$ makes a jump from $\mathcal{S}(t)$ to $\mathcal{F}(t)$ is also denoted as an outcrossing point.

The complementary set to the safe set (15.2.1) is

$$\{\mathbf{X}(0) \in \mathcal{F}(0)\} \cup \{N(T) > 0\} \quad (15.2.2)$$

which is the failure set. Let the probability on this set be denoted by $p_f(0, T)$. Since the two events in (15.2.2) are not disjoint we have

$$p_f(0, T) \leq p_f(0, 0) + P[N(T) > 0] \quad (15.2.3)$$

where

$$p_f(0, 0) = P[\mathbf{X}(0) \in \mathcal{F}(0)] \quad (15.2.4)$$

Moreover, since

$$\begin{aligned} P[N(T) > 0] &= P[N(T) = 1] + P[N(T) = 2] + \dots \\ &\leq P[N(T) = 1] + 2P[N(T) = 2] + \dots = E[N(T)] \end{aligned} \quad (15.2.5)$$

we get by substitution into (15.2.3) that

$$p_f(0, 0) \leq P \left[\bigcup_{i=1}^n \{\mathbf{X}(t_i) \in \mathcal{F}(t_i)\} \right] \leq p_f(0, T) \leq p_f(0, 0) + E[N(T)] \quad (15.2.6)$$

where $t_1 = 0 < t_2 < \dots < t_n \leq T$ are arbitrary time points. The inequalities (15.2.6) remains true, of course, if $p_f(0,0)$ is replaced by $p_f(t_i,0) = P[\mathbf{X}(t_i) \in \mathcal{F}(t_i)]$ for any arbitrary t_i . The right side can similarly be replaced by $p_f(t,0) + E[N_{\text{in}}(0,t)] + E[N_{\text{out}}(t,T)]$ where $E[N_{\text{in}}(0,t)]$ is the number of incrossings in the time interval from 0 to t while $E[N_{\text{out}}(t,T)]$ is the number of outcrossings in the time interval from t to T . It follows from this that in order to determine an upper bound on the failure probability it is only needed to determine the instantaneous failure probability $p_f(t,0)$ (the marginal failure probability) corresponding to an arbitrary time point $t \in [0, T]$ and the expected number of incrossings in the interval $[0, t]$ and the expected number of outcrossings in the interval $[t, T]$.

For slowly varying load vector processes a statical analysis of the structure will usually be sufficient. For slowly varying stationary load processes and relevant planned lifetimes T of the structure the expectation $E[N(T)]$ is often of the same order of size as $p_f(0,0)$. (A vector process $\mathbf{X}(t)$ is said to be stationary if the vector process $\mathbf{X}(t+\tau)$ corresponding to an arbitrary but fixed τ has the same probabilistic structure as $\mathbf{X}(t)$.) Since uncertainties up to a factor as large as 2 in the determination of the practically relevant very small failure probability $p_f(0, T)$ only have modest consequences for the dimensions of the structure, it is in such cases less important to determine $E[N(T)]$ with great accuracy. Noting this we get the advantage in such cases that it is unnecessary to formulate a load model with large degree of detailing. A crude evaluation of $E[N(T)]$ can be sufficient especially when $E[N(T)] < p_f(0,0)$.

If the load process is not stationary, more care should be exercised. For example, the situation might be that the load process always starts within the safe set and at most has one outcrossing of the safe set in the interval $[0, T]$. Then $p_f(0,0) = 0$ such that the upper bound on $p_f(0, T)$ is determined solely by $E[N(T)]$. This situation is present for a rigid-ideal plastic structure with the load applied by proportional loading from zero. In this case we have $p_f(0, T) = p_f(T,0) = E[N(T)]$, that is, $p_f(0, T)$ is the marginal failure probability at the time T .

In Chapter 14 we assumed as a condition for the reliability analysis of a rigid-ideal-plastic structure that the loading path corresponds to proportional loading. The purpose of this limitation of the load path behavior was to ensure that there is at most one outcrossing out of the time invariant safe set \mathcal{S} such that the analysis can be based solely on a specification of the probability distribution of the end point of the loading path. It is seen here that if $E[N(T)]$ can be calculated, then completely general load paths corresponding to a random vector process $\mathbf{X}(t)$ can be handled. If the calculations are based on the lower-bound theorem of the plasticity theory we just use the right side of (15.3.6). In case of using the upper-bound theorem it is the left side of (15.3.6) that should be used, of course. This generality with respect to the loading path is a consequence of the fact that the safe set \mathcal{S} is independent of the load-path history. As it has been demonstrated in Chapter 14, this simple property is lost for the structural systems that are not rigid-ideal-plastic. The inequalities (15.3.6) are valid generally, however. The difficulty is to use the inequalities when the failure set depends on the loading path.

15.3 Expected number of outcrossings

If we assume that the vector process $\mathbf{X}(t)$ and the set $\mathcal{S}(t)$ have such properties that the time interval from t to $t + \Delta t$ contains two or more crossings through the boundary $\partial\mathcal{S}(t)$ (in- or outcrossings)

with a probability which is of higher order in Δt than Δt (that is, for each integer $i \geq 2$ there is a constant p_i such that the probability of getting $i \geq 2$ crossings is $p_i o(\Delta t)$) then we obviously have that

$$\lim_{\Delta t \rightarrow 0} \frac{1}{\Delta t} E[N(t + \Delta t) - N(t)] = \lim_{\Delta t \rightarrow 0} \frac{1}{\Delta t} P[N(t + \Delta t) - N(t) = 1] \quad (15.3.1)$$

provided $\sum_{i=2}^{\infty} i p_i < \infty$ and provided the limit value in (15.3.1) exists. Within the structural reliability theory it is sufficient to consider outcrossing problems for processes with these general properties. It is noted that the event

$$\{\mathbf{X}(t) \in \mathcal{S}(t)\} \cap \{\mathbf{X}(t + \Delta t) \in \mathcal{F}(t + \Delta t)\} \quad (15.3.2)$$

implies the event

$$\{N(t + \Delta t) - N(t) \geq 1\} \quad (15.3.3)$$

and that the difference event between (15.3.3) and (15.3.2) (that is, the event that (15.3.3) occurs without the occurrence of (15.3.2)) is a subevent of the event that at least two crossings occur (in or out). It follows from this that the probability of the event (15.3.3) is bounded between the probability of the event (15.3.2) and the sum of this probability and the probability of getting an even number of crossings. Since this last term is $o(\Delta t)$, we obviously get that

$$\lim_{\Delta t \rightarrow 0} \frac{1}{\Delta t} E[N(t + \Delta t) - N(t)] = \lim_{\Delta t \rightarrow 0} \frac{1}{\Delta t} P[\{\mathbf{X}(t) \in \mathcal{S}(t)\} \cap \{\mathbf{X}(t + \Delta t) \in \mathcal{F}(t + \Delta t)\}] \quad (15.3.4)$$

since $P[N(t + \Delta t) - N(t) \geq 1]$ and $P[N(t + \Delta t) - N(t) = 1]$ in (15.3.1) only differs by terms of the order $o(\Delta t)$. The limit on the left side of (15.3.4) is denoted as $v_+(t)$ and it is called the outcrossing intensity at the time t . For a given deterministic time variation of $\mathcal{S}(t)$ it is seen to depend solely on the two-dimensional distributions (in time) for the vector process $\mathbf{X}(t)$ and solely on the properties of these distributions within a neighborhood along the "diagonal" $t_1 = t_2$. Finally the mean number of outcrossings of $\mathcal{S}(t)$ during the time interval $[0, T]$ becomes

$$E[N(T)] = \int_0^T v_+(t) dt \quad (15.3.5)$$

because $N(T)$ is the sum of the increments $N(t + \Delta t) - N(t)$ from $t = 0$ to $t = T$.

In particular, if the process is a scalar process and $\mathcal{S}(t) =]-\infty, z(t)]$ where $z(t)$ is a given level function, the upcrossing intensity becomes, see Fig. 15.1 at the left side,

$$v_+ = \lim_{\Delta t \rightarrow 0} \frac{1}{\Delta t} \{F_{X(t)}[z(t)] - F_{X(t), X(t+\Delta t)}[z(t), z(t + \Delta t)]\} \quad (15.3.6)$$

Example 15.1 Define a load process according to the same principles as for the FBC load process but with the points of the load changes occurring as the incidents of a Poisson process. This type of process is called a Poisson "square-wave" process. Let the amplitudes be mutually independent

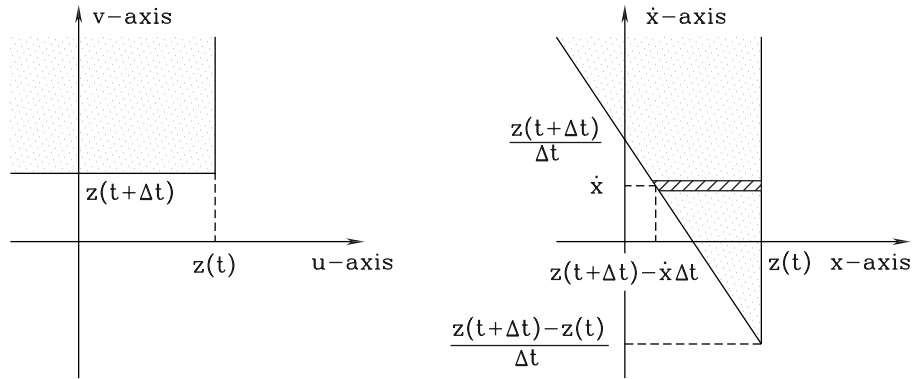

Figure 15.1: Coordinate system diagrams that illustrate the deduction of the level upcrossing intensity of a random process (Rice's formula).

with the distribution function $F(x)$ and let the Poisson process have the intensity c . According to (15.3.6) the upcrossing intensity of the level z equals

$$v_+ = \lim_{\Delta t \rightarrow 0} \frac{1}{\Delta t} \{F(z) - [F(z)(1 - c\Delta t) + F(z)^2\Delta t]\} = cF(z)[1 - F(z)] \quad (15.3.7)$$

This result is directly obtained by considering that the point process of upcrossings are obtained by independent thinning of the Poisson point by the thinning probability $F(z)[1 - F(z)]$. The point process of upcrossings is then itself a Poisson process. \square

If the process possesses two-dimensional probability densities, the formula (15.3.6) may be written as

$$v_+ = \lim_{\Delta t \rightarrow 0} \frac{1}{\Delta t} \int_{-\infty}^{z(t)} du \int_{z(t+\Delta t)}^{\infty} f_{X(t), X(t+\Delta t)}(u, v) dv \quad (15.3.8)$$

By the one-to-one mapping

$$(u, v) = (x, x + \dot{x}\Delta t), \quad (x, \dot{x}) = \left(u, \frac{v - u}{\Delta t}\right) \quad (15.3.9)$$

we have that

$$f_{X(t), X(t+\Delta t)}(u, v) = f_{X(t), \dot{X}(t)}(x, \dot{x}) \frac{1}{\Delta t} \quad (15.3.10)$$

where $\dot{X}(t) = [X(t + \Delta t) - X(t)]/\Delta t$. Thus (15.3.8) can be written as, see Fig 15.1 at the right side,

$$v_+ = \lim_{\Delta t \rightarrow 0} \int_{\frac{z(t+\Delta t) - z(t)}{\Delta t}}^{\infty} \left[\frac{1}{\Delta t} \int_{z(t+\Delta t) - \dot{x}\Delta t}^{z(t)} f_{X(t), \dot{X}(t)}(x, \dot{x}) dx \right] d\dot{x} \quad (15.3.11)$$

The mean-value theorem applied to the inner integral of (15.3.11) followed by the limit passage $\Delta t \rightarrow 0$ then gives

$$v_+ = \int_{\dot{z}(t)}^{\infty} [\dot{x} - \dot{z}(t)] f_{X(t), \dot{X}(t)}[z(t), \dot{x}] d\dot{x} \quad (15.3.12)$$

in which $\dot{z}(t)$ is the derivative of $z(t)$ and $\dot{X}(t)$ is the derivative of $X(t)$. This is *Rice's formula*, obtained here without consideration of mathematical rigor.

Example 15.2 For a stationary Gaussian process with mean value 0 and covariance function $c(t_1, t_2) = \sigma^2 \rho(t_2 - t_1)$, $\rho(0) = 1$, $\rho'(0) = 0$, $\rho''(0) > -\infty$, the variables $X(t)$ and $\dot{X}(t)$ are mutually independent because $X(t)$ and $\dot{X}(t)$ are uncorrelated for any stationary process. The derivative $\dot{X}(t)$ has zero mean value and the variance

$$\begin{aligned} \text{Var}[\dot{X}(t)] &= \lim_{\Delta t \rightarrow 0} \text{Var} \left[\frac{X(t + \Delta t) - X(t)}{\Delta t} \right] \\ &= \lim_{\Delta t \rightarrow 0} \left\{ \frac{1}{\Delta t^2} (\sigma^2 + \sigma^2 - 2\sigma^2 \rho(\Delta t)) \right\} = -\sigma^2 \rho''(0) \end{aligned} \quad (15.3.13)$$

using l'Hospital's rule. Thus we find that (15.3.12) gives

$$v_+(t) = \left[\int_0^\infty \dot{x} \frac{1}{\sigma \sqrt{-\rho''(0)}} \varphi \left(\frac{\dot{x} + \dot{z}(t)}{\sigma \sqrt{-\rho''(0)}} \right) d\dot{x} \right] \frac{1}{\sigma} \varphi \left(\frac{z(t)}{\sigma} \right) \quad (15.3.14)$$

In particular, if $\dot{z}(t) \equiv 0$, the mean upcrossing rate (15.3.14) becomes

$$v_+(t) = \sqrt{\frac{-\rho''(0)}{2\pi}} \varphi \left(\frac{z}{\sigma} \right) \quad (15.3.15)$$

□

The formula (15.3.12) can be interpreted directly by help of a sketch of the sample curves as they pass through the interval from t to $t + \Delta t$, see Fig. 5.2. With given slope \dot{x} the fraction of the set of sample curves that cross up through the curve defined by the level function $z(t)$ will be given by the product of the interval length $[\dot{x} - \dot{z}(t)]\Delta t$ for x and the density $f_{X(t), \dot{X}(t)}[z(t), \dot{x}]$. Since upcrossings only exist for slopes \dot{x} that are larger than the slope $\dot{z}(t)$, the probability of getting an upcrossing in the considered interval is obtained by integration of this product from $\dot{z}(t)$ to ∞ .

It is noted that (15.3.12) can be written as

$$v_+(t) = E[\max\{0, \dot{X}(t) - \dot{z}(t)\} | X(t) = z(t)] f_{X(t)}[z(t)] \quad (15.3.16)$$

The outcrossing intensity of the vector process $\mathbf{X}(t)$ out of $\mathcal{S}(t)$ can be written in an analogous way. Let the time development of $\mathcal{S}(t)$ be given by a deterministic velocity vector field $\mathbf{v}(\mathbf{x}, t)$ in the sense that the surface $\partial\mathcal{S}(t)$ follows the velocity field $\mathbf{v}(\mathbf{x}, t)$ and changes its form in accordance with $\mathbf{v}(\mathbf{x}, t)$. Consider any outcome $\mathbf{x}(t)$ of the vector process $\mathbf{X}(t)$ as the position vector of a particle that moves with the velocity $\dot{\mathbf{x}}(t) - \mathbf{v}(\mathbf{x}, t)$ relative to an infinitesimal surface element part of $\partial\mathcal{S}(t)$ with "area" $d\partial\mathcal{S}(t)$ and situated at the point \mathbf{x} . Then the particle will cross out through this surface element in the time interval from t to $t + dt$ if and only if $\mathbf{x}(t)$ is within an infinitesimal volume element contained in $\mathcal{S}(t)$ and having the volume $[\dot{\mathbf{x}}(t) - \mathbf{v}(\mathbf{x}, t)]^\top \mathbf{n}(\mathbf{x}) d\partial\mathcal{S}(t) dt$. The vector $\mathbf{n}(\mathbf{x})$ is the outwards directed unit normal vector to $\partial\mathcal{S}(t)$ at the point \mathbf{x} . If this volume is negative the particle crosses from the outside and into $\mathcal{S}(t)$. The probability of occurrence within a time unit at time t of an outcrossing with velocity $\dot{\mathbf{x}}(t)$ through the surface element at the point $\mathbf{x}(t) \in \partial\mathcal{S}(t)$ and with an orientation given by the unit normal vector $\mathbf{n}(\mathbf{x})$ thus is

$$\max\{0, [\dot{\mathbf{x}}(t) - \mathbf{v}(\mathbf{x}, t)]^\top \mathbf{n}(\mathbf{x})\} f_{\mathbf{X}(t), \dot{\mathbf{X}}(t)}(\mathbf{x}, \dot{\mathbf{x}}) d\partial\mathcal{S}(t) d\mathbb{R}^n \quad (15.3.17)$$

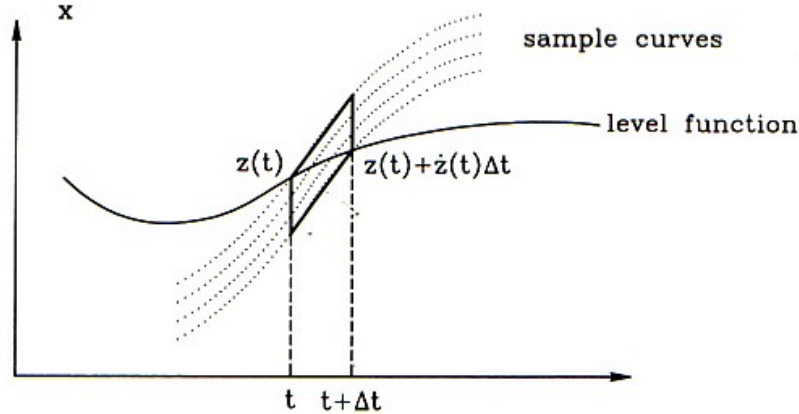

Figure 15.2: Direct graphical interpretation of Rice's formula.

Hereafter the probability of occurrence of an outcrossing through $\partial\mathcal{S}(t)$ within a time unit at time t is obtained by integration with respect to $\dot{\mathbf{x}}$ followed by an integration with respect to \mathbf{x} over all of $\partial\mathcal{S}(t)$. This is a consequence of the fact that outcrossing through disjoint surface elements at time t are mutually exclusive events. Thus we get the outcrossing intensity

$$\begin{aligned} v_+(t) &= \int_{\mathbf{x}(t) \in \partial\mathcal{S}(t)} d\partial\mathcal{S}(t) \int_{\dot{\mathbf{x}}(t) \in \mathbb{R}^n} \max\{0, [\dot{\mathbf{x}}(t) - \mathbf{v}(\mathbf{x}, t)]^\top \mathbf{n}(\mathbf{x})\} f_{\mathbf{X}(t), \dot{\mathbf{X}}(t)}(\mathbf{x}, \dot{\mathbf{x}}) d\mathbb{R}^n \\ &= \int_{\mathbf{x}(t) \in \partial\mathcal{S}(t)} E[\max\{0, [\dot{\mathbf{X}}(t) - \mathbf{v}(\mathbf{x}, t)]^\top \mathbf{n}(\mathbf{x})\} | \mathbf{X} = \mathbf{x}] f_{\mathbf{X}(t)}(\mathbf{x}) d\partial\mathcal{S}(t) \end{aligned} \quad (15.3.18)$$

This formula is a generalization of Rice's formula. It is sometimes referred to as *Belayev's formula*.

The formulas (15.3.4) and (15.3.6) and Rice's and Belayev's formulas for the determination of the integrand $v_+(t)$ in (15.3.5) form, together with the tools given in this textbook, the basis that with reference to the inequalities (15.2.6) can be used for a reliability analysis based on random process models. The practical calculation of the outcrossing intensity depends on the specific process type relevant for the application. The evaluation can often be made with sufficient accuracy by use of asymptotic results of the same nature as the results that underlie FORM and SORM. However, these topics are outside the scope of this book. Here we will be content by illustrating that the outcrossing intensity as given by Belayev's formula (15.3.18) can be estimated by use of the Monte Carlo simulation technique described in Chapter 9.

15.4 Determination of the expected number of outcrossings by directional simulation*

As in Chapter 9 on Monte Carlo methods we can reformulate the integral in (15.3.18) over the surface $\partial\mathcal{S}(t)$ to an expectation of a suitable random variable that has all its probability distribution concentrated on $\partial\mathcal{S}(t)$. This can be made in a simple way in a polar representation of the surface

$\partial\mathcal{S}(t)$. For simplicity, let us assume that the origin of the coordinate system is in the inner of $\mathcal{S}(t)$ and that $\mathcal{S}(t)$ is star-shaped with respect to the origin. Moreover, let us assume that the unit normal vector $\mathbf{n}(\mathbf{x})$ almost everywhere on the surface $\partial\mathcal{S}(t)$ is not orthogonal to \mathbf{x} , that is, $\mathbf{x}^\top \mathbf{n}(\mathbf{x}) \neq 0$ almost everywhere on $\partial\mathcal{S}(t)$ (by which we mean everywhere except for \mathbf{x} in a subset of zero “area”). By a projection consideration setting $\mathbf{x} = r(\boldsymbol{\alpha}, t)\boldsymbol{\alpha}$, $\|\boldsymbol{\alpha}\| = 1$, it is then seen that the relation

$$d\partial\mathcal{S}(t) = \frac{r(\boldsymbol{\alpha}, t)^{n-1}}{\boldsymbol{\alpha}^\top \mathbf{n}[r(\boldsymbol{\alpha}, t)\boldsymbol{\alpha}]} d\mathcal{K} \quad (15.4.1)$$

is valid between the “area” $d\mathcal{K}$ of the infinitesimal surface element on the unit sphere \mathcal{K} with center at the origin and the “area” $d\partial\mathcal{S}(t)$ of the infinitesimal surface element on the surface $\partial\mathcal{S}(t)$. This means that it is easy to rewrite the integral (15.3.18) to an integral over \mathcal{K} . If we define an everywhere positive probability density $f_{\mathbf{A}}(\boldsymbol{\alpha})$ on \mathcal{K} for the unit directional vector \mathbf{A} , we can divide and multiply the integrand by this density and thereafter interpret the integral as an expectation exactly as in Chapter 9. Here this expectation gets the form

$$v_+(t) = E \left[\frac{r(\mathbf{A}, t)^{n-1} w(\mathbf{A}, t)}{f_{\mathbf{A}}(\mathbf{A}) \mathbf{A}^\top \mathbf{n}[r(\mathbf{A}, t)\mathbf{A}]} f_{\mathbf{X}(t)}[r(\mathbf{A}, t)\mathbf{A}] \right] \quad (15.4.2)$$

where

$$w(\mathbf{A}, t) = E \left[\max\{0, \{\dot{\mathbf{X}}(t) - \mathbf{v}[r(\mathbf{A}, t)\mathbf{A}, t]\}^\top \mathbf{n}[r(\mathbf{A}, t)\mathbf{A}]\} \mid \mathbf{X}(t) = r(\mathbf{A}, t)\mathbf{A} \right] \quad (15.4.3)$$

In principle, therefore, we can get an estimate of the outcrossing intensity $v_+(t)$ by directional simulation under use of a suitable simulation distribution that defines the density $f_{\mathbf{A}}(\boldsymbol{\alpha})$ on the unit sphere \mathcal{K} . The class of simulation distributions suggested in Chapter 9 may also be useful in this connection. In particular the density corresponding to uniform directional simulation is

$$f_{\mathbf{A}}(\boldsymbol{\alpha}) = \frac{1}{\text{“area” of } \mathcal{K}} = \frac{\Gamma(n/2)}{2\pi^{n/2}} \quad (15.4.4)$$

where $\Gamma(x+1) = x\Gamma(x)$, $\Gamma(\frac{1}{2}) = \sqrt{\pi}$, and $\Gamma(1) = 1$.

In the particular case where $\mathbf{X}(t)$ is a Gaussian vector process that satisfies the condition that $\mathbf{X}(t)$ and $\dot{\mathbf{X}}(t)$ are mutually independent for any fixed t , the function $w(\mathbf{A}, t)$ in (15.4.3) becomes (see e.g. [9.5])

$$w(\mathbf{A}, t) = D[\dot{\mathbf{N}}(\mathbf{A}, t)] \psi \left(\frac{E[\dot{\mathbf{N}}(\mathbf{A}, t)]}{D[\dot{\mathbf{N}}(\mathbf{A}, t)]} \right) \quad (15.4.5)$$

where

$$\dot{\mathbf{N}}(\mathbf{A}, t) = \{\dot{\mathbf{X}}(t) - \mathbf{v}[r(\mathbf{A}, t)\mathbf{A}, t]\}^\top \mathbf{n}[r(\mathbf{A}, t)\mathbf{A}] \quad (15.4.6)$$

and $\psi(\cdot)$ is the function defined by the formula

$$\psi(x) = \varphi(x) + x\Phi(x) \quad (15.4.7)$$

The applicability of the simulation method depends to a large degree whether it is possible to obtain a fast determination of $w(\boldsymbol{\alpha}, t)$ for each outcome $\boldsymbol{\alpha}$ of \mathbf{A} .

15.5 Some simple load models of Poisson type

The load model in Chapter 10 (the FBC load model) is formulated with the purpose of representing so-called intermittent load histories and their combinations to a degree of detailing sufficient for the reliability analysis of buildings. A load history is said to be intermittent if it consists of a sequence of load pulses of more or less random form and duration separated by time intervals without loads. In particular, these time intervals without load can have vanishing duration. In the FBC model both the load pulse durations and the separating time intervals are discretized to have certain specific durations and the pulse shapes are rectangular. Moreover, the different FBC load processes considered for combination are artificially fitted to each other with respect to the choice of the load pulse durations and the duration of the separating intervals.

A more natural class of load models for intermittent load histories is generated by use of Poisson processes. Let $N(t), t \in \mathbb{R}_+$, be a homogeneous Poisson process with intensity c , that is, a process for which (15.1.3) is valid. Assume that each of the incidents that are counted by $N(t)$ are occurrences of a load pulse whose time position, shape and size are jointly given by a function $h(t, N(\cdot), S, D)$ of the time t , the Poisson process $N(\cdot)$, the pulse size S (= the amplitude), and the pulse duration D . Then the load process can be written as

$$X(t) = \sum_{n=0}^{N(t)} h(t, \{T_i\}, S_n, D_n) \tag{15.5.1}$$

in which we have written the Poisson process $N(\cdot)$ as the sequence T_i of jump points. Examples are the compound Poisson point process where the load pulse has the shape

$S_n \delta(t - T_n)$

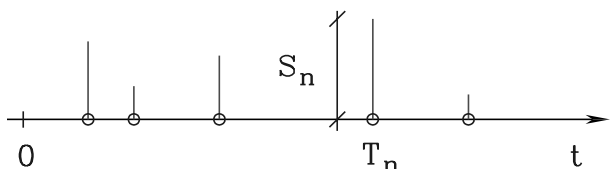

The graph shows a horizontal time axis t starting at 0 . Several vertical spikes (impulses) are plotted at jump points T_n . The height of each spike is labeled S_n . The spikes occur at irregular intervals along the time axis.

(15.5.2)

the Poisson “square-wave” process where the load pulse has the shape, see Example 15.1,

$S_n \mathbf{1}_{T_n \leq t < T_{n+1}}$

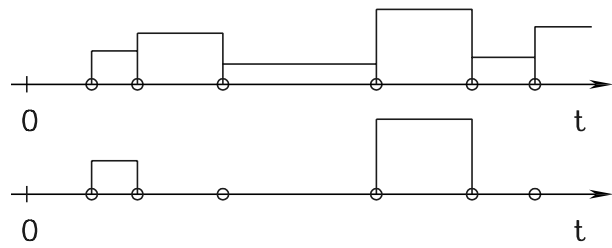

The graph shows two horizontal time axes t starting at 0 . The top axis shows a sequence of rectangular pulses. Each pulse starts at a jump point T_n and ends at the next jump point T_{n+1} . The height of each pulse is constant. The bottom axis shows the same jump points T_n as small circles on the time axis.

(15.5.3)

and which is a special case of the Poisson pulse process where the load pulse has the shape

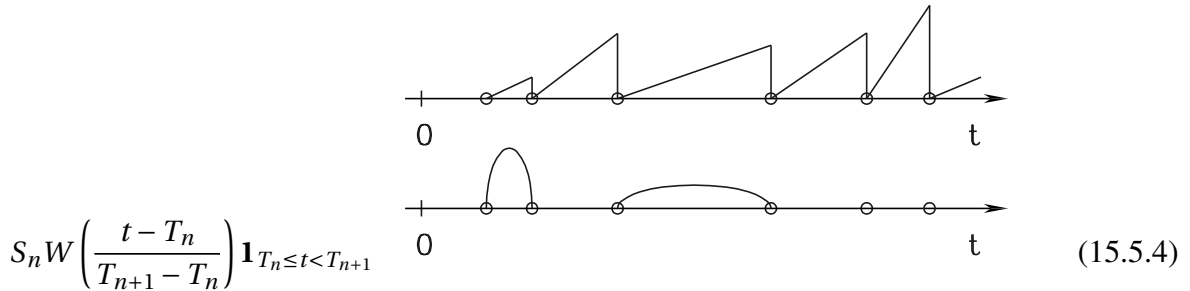

In (15.5.4), $W(\cdot)$ is a pulse shape function with the interval $[0, 1]$ as definition set. Finally the filtered Poisson “square-wave” process should be mentioned. In this process the load pulse has the shape

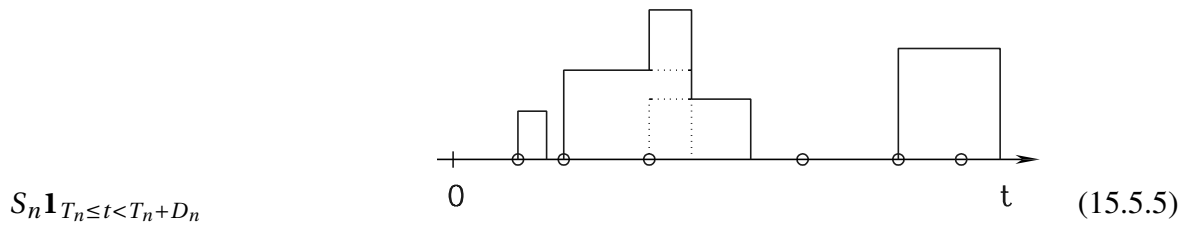

and the load pulses may overlap each other.

For these types of load models the load combination problem becomes quite difficult. In this respect the compound Poisson point process defined by (15.5.2) is an important exception. This is because the sum of an arbitrary number of mutually independent Poisson processes is a Poisson process with intensity $c_1 + \dots + c_m$, where c_1, \dots, c_m are the intensities of the individual Poisson processes. Since the load pulses are of zero duration and the jumps of a Poisson process are separated in time, the load pulses will almost never overlap each other.

Assume that the load pulses of the i th process are mutually independent and identically distributed with the distribution function $F_i(x)$ and denote the complementary distribution function by $\bar{F}_i(x) = 1 - F_i(x)$. Then the probability that a load pulse with amplitude larger than x occurs in the time interval from t to $t + \Delta t$ in the i th process is equal to $c_i \bar{F}_i(x) \Delta t +$ (terms of higher order in Δt). Thus the counting process that counts the number of load pulses with amplitude larger than x is a Poisson process with intensity $c_i \bar{F}_i(x)$. For the sum of the m compound Poisson point processes we therefore have that the corresponding counting process is a Poisson process $N(t)$ with intensity $c_1 \bar{F}_1(x) + \dots + c_m \bar{F}_m(x)$. The probability that there is no load pulse with amplitude that exceeds x within the interval $[0, T]$ is thus

$$P[N(T) - N(0) = 0] = \exp \left[-T \sum_{i=1}^m c_i \bar{F}_i(x) \right] \quad (15.5.6)$$

As a function of x the right side of (15.5.6) is the distribution function of the maximal load pulse amplitude (or load effect amplitude, if the load amplitudes have been multiplied by the relevant influence factors) within the time interval $[0, T]$.

This simple model is applicable if the load pulse durations are very short relative to the time distances between the load pulses in all the load processes that are considered for combination. If

this assumption is doubtful, it is possible to introduce corrections to (15.5.6) that take the possibility of overlapping load pulses into consideration. These corrections give some overestimation of the probability that the combined load process gets a realization with a load effect value larger than x in the interval $[0, T]$. The procedure is only reasonable, however, if it can be assumed that the load pulse durations are essentially shorter than the time distances between the load pulses.

Let us assume that the load processes considered for combination are mutually independent filtered Poisson "square-wave" processes with $E[D_n] \ll E[T_{n+1} - T_n] = 1/c$, see (15.5.5). Moreover, let us assume that all the pulse amplitudes and pulse durations within the same process are identically distributed and mutually independent, and that the amplitudes and durations are mutually independent. In the following we change the indexing such that $F_{D_i}(x)$ and $F_{S_i}(x)$ from now on denote the distribution functions for the load pulse duration and the load effect pulse amplitude in the i th process, respectively.

Obviously the probability that there is a load pulse from the i th process in the time interval $[t, t + \Delta t]$ followed by one or more load pulses from the j th process within the duration interval given by D_i is (assuming that D_i has the density function $f_{D_i}(x)$)

$$[c_i \Delta t + o(\Delta t)] \int_0^\infty (1 - e^{-c_j x}) f_{D_i}(x) dx < c_i c_j E[D_i] \Delta t + o(\Delta t) \quad (15.5.7)$$

since $1 - e^{-c_j x} < c_j x$ is the probability that at least one load pulse occurs in process j within a time interval of duration x . For $E[D_i] \ll 1/c_j$ there is only a small difference between the two sides of (15.5.7). The considered event implies that after the occurrence of the load pulse from the i th process in $[t, t + \Delta t]$ there occurs an overlap with a load pulse from the j th process. By interchanging of i and j another event of overlap is obtained. The event of getting an overlap directly after the occurrence of a load pulse either from the i th process or the j th process within the time interval $[t, t + \Delta t]$ is the union of the two events. Thus the overlap events occurring in the sum of the two processes are incidents in a Poisson process with an intensity which is less than

$$c_{ij} = c_i c_j (E[D_i] + E[D_j]) \quad (15.5.8)$$

Due to the overlapping load pulses the intensity of the Poisson point process with isolated load pulses within the i th process will be less than c_i .

For the case $m = 2$ in (15.5.6) we thus get that (15.5.6) can be modified to the inequality

$$P \left(\max_{[0, T]} \left\{ \begin{array}{l} \text{combined} \\ \text{load process} \end{array} \right\} \leq x \right) \geq \exp\{-T[c_1 \bar{F}_{S_1}(x) + c_2 \bar{F}_{S_2}(x) + c_{12} \bar{F}_{S_1+S_2}(x)]\} \quad (15.5.9)$$

We now take a step further and consider the overlap of three load pulses, one from each of the processes with indices i, j and k . For this case the probability problem becomes much more difficult. Therefore we will be content by considering an event that contains the overlap event as a subevent. Consider the event that there is a load pulse from the k th process in the interval $[t, t + \Delta t]$ and that this event is followed by one or more pairs of overlapping load pulses from the i th and the j th process with start of occurrence within the duration interval given by D_k . Following the principle in (15.5.7) we then have by use of (15.5.8) that the intensity of the Poisson process of this type of events are less than

$$c_i c_j (E[D_i] + E[D_j]) c_k E[D_k] \quad (15.5.10)$$

The considered event implies an overlap of a load pulse from the k th process with a load pulse from the i th process or the j th process where the load pulses from the last two processes overlap. The succession of load pulse starts in time is either k, i, j or k, j, i with load pulse start for the k th process in the interval $[t, t + \Delta t]$. Since besides this there are two index combinations that start with i and j , respectively, that can imply overlap of all three load pulses, we find that the Poisson process with the intensity

$$2c_{ijk} = 2c_i c_j c_k (E[D_i]E[D_j] + E[D_i]E[D_k] + E[D_j]E[D_k]) \quad (15.5.11)$$

has larger intensity than the Poisson process in which the incidents are overlap of three load pulses, one from each of the three load processes.

For the case $m = 3$ in (15.5.6) we thus have that (15.5.6) can be modified to the inequality

$$P\left(\max_{[0, T]} \{\text{combined load process}\} \leq x\right) \geq \exp\left\{-T \left[\sum_{i=1}^3 c_i \bar{F}_{S_i}(x) + \sum_{i \neq j}^3 \sum_{i \neq j}^3 c_{ij} \bar{F}_{S_i + S_j}(x) + 2 \sum_{i \neq j \neq k}^3 \sum_{i \neq j \neq k}^3 c_{ijk} \bar{F}_{S_i + S_j + S_k}(x) \right]\right\} \quad (15.5.12)$$

The principle for generalization of (15.5.12) is now obvious. We have

$$P\left(\max_{[0, T]} \{\text{combined load process}\} \leq x\right) \geq \exp\left\{-T \sum_{n=1}^m (n-1)! \sum_{i_1 \neq i_2 \neq \dots \neq i_n}^m \dots \sum_{i_1 i_2 \dots i_n}^m c_{i_1 i_2 \dots i_n} \bar{F}_{S_{i_1} + S_{i_2} + \dots + S_{i_n}}(x)\right\} \quad (15.5.13)$$

By approximate probability considerations and simulation studies Wen [15.7,8] has experienced that (15.5.13) without the factors $(n-1)!$ in a large number of examples gives a good approximation to the left side. In fact, in the special case where all durations are equal one finds that the overlap event conditional on the event considered in the derivation of (15.5.10) occurs with the probability $\int_0^1 dx_2 \int_0^{x_2} dx_3 \dots \int_0^{x_{n-2}} x_{n-1} dx_{n-1} = 1/(n-1)!$.

This model for combination of intermittent load processes with "rare" load pulses of short duration is in the literature known as *Wen's load-coincidence model*. It is clear that the inequality (15.5.13) is valid for any type of load processes of the form (15.5.1) and not just for the filtered Poisson "square-wave" process given that the load effect pulses all are non-negative and that S denotes the maximal load effect within the load pulse.

Finally it is noted that the combined intermittent load process with "rare" occurrences of load pulses of short duration usually is considered for combination with an intermittent load process that have load pulses of long duration and very short time intervals without load (e.g. a load process for sustained load and service load). An exact solution exists for the sum of a compound Poisson point process (process 1) and a Poisson square-wave process (process 2). Without giving the proof, [15.3], we have that

$$P[\max_{[0, T]} \{X_1(t) + X_2(t)\} \leq x] = g(T, x) e^{-c_2 T} \quad (15.5.14)$$

where the function $g(T, x)$ satisfies the integral equation

$$F(t, x) + c_2 \int_0^t F(t-u, x)g(u, x) du = g(t, x) \quad (15.5.15)$$

with

$$F(t, x) = \int_0^x f_{X_2}(x-y) \exp\{-c_1 t[1 - F_{X_1}(y)]\} dy \quad (15.5.16)$$

15.6 Historical and bibliographical notes

The evaluation of the failure probability by the expected number of outcrossings through the limit-state surface was first considered by V.V. Bolotin in 1959 [15.1,p.371] and in the more complete form (15.2.6) by M. Shinozuka in 1964 [15.6].

Load coincidence studies for pulse process models of Poisson type were made systematically by Y-K. Wen in 1977 [15.7], and in 1990 he published a monograph about the topic [15.8]. The integral equation (15.5.15) is formulated by A.M. Hasofer in 1974 [15.3].

Examples on the application of the random processes described in this chapter to model the commonly appearing load types are given by H.O. Madsen *et al.* [15.4]. There exists a very large literature that describes applications of the concept of random processes in the theory of structural reliability. Since the present chapter is only introductory, the description of this literature is outside the scope of the book. Also it is not relevant to make a historical exposition of the enormous literature on random processes in general. Here it should only be mentioned that the book of H. Cramér and M.R. Leadbetter [15.2] has been a useful source for the authors. Concerning Poisson processes the book of E. Parzen [15.5] is reasonably easy for engineers with good mathematical background.

Bibliography

- [15.1] V.V. Bolotin (1981) *Wahrscheinlichkeitsmethoden zur Berechnung von Konstruktionen*, VEB Verlag für Bauwesen Berlin, Berlin, Germany.
- [15.2] H. Cramér and M.R. Leadbetter (1967) *Stationary and Related Stochastic Processes*, Wiley, New York.
- [15.3] A.M. Hasofer (1974) Time dependent maximum of floor live loads, *J. Eng. Mech.*, ASCE, **100**, 1086-1091.
- [15.4] H.O. Madsen, S. Krenk and N.C. Lind (1986) *Methods of Structural Safety*, Prentice-Hall, Englewood Cliffs, New Jersey.
- [15.5] E. Parzen (1962) *Stochastic Processes*. Holden-Day, San Francisco.
- [15.6] M. Shinozuka (1964) Probability of structural failure under random loading, *Journal of the Eng. Mech. Div.*, ASCE, **90**, 147-70.
- [15.7] Y-K.Wen (1977) Statistical combination of loads, 3. *Journal of Struct. Div.*, ASCE, **103**, 1079-93.

[15.8] Y-K.Wen (1990) *Structural Load Modeling and Combination for Performance and Safety Evaluation*. Developments in Civil Engineering, Elsevier, Amsterdam.

This page is intentionally left blank.

Chapter 16

Appendix 1: CODE CALIBRATION

16.1 Principles of code calibration

The concept of a design code for structures is explained in Chapter 2. In this appendix we need the abstract concept of a code format. A code format is a formal system of variables together with a set of rules. The rules define the relations between these variables and their relations to the mechanical modeling of the structure and the actions on the structure. Code calibration is the particular activity exercised by some authority (a code committee, say) when it applies some superior method to assign values to the variables of the code format such that a specific design code is formulated. For a code format of the partial safety factor type, the variables are characteristic values, partial coefficients, and load reduction factors. A code can be calibrated on different levels of superior methods. By and large the calibration levels can be categorized as use of judgemental value assignment, calibration to existing design practice, or best fit to a superior formal reliability evaluation method (code optimization).

Calibration by judgment was the predominant way of value assignment until about 1960. A code that gives satisfactory experiences of safe design through several years of practical use was considered to have reasonably correct values of the parameters. Economical reasons might lead to revisions of the values in the direction of giving cheaper and less safe structures. On the other hand, experiences about too many failures or weaknesses caused revisions with changes of the parameter values in the direction of more safe structures. In the long run the value assignments to the code format stabilize because no reasons appear for pointing at the necessity of new revisions. Obviously there are several drawbacks of such judgemental calibration. In particular it has a restrictive influence on the use of new materials, new structural principles, and developments in new fields where only limited experiences about the extreme actions are available. Due to the lack of rational analysis as the basis for the judgemental calibration, the resulting code, when used on such new developments, will often lead to unnecessarily safe and expensive structures and thus be restrictive with respect to the technological development.

Calibration to existing design practice is often used as a value assignment method in situations where a change of the code format is actual. The motivation for such a change of the code format can be the wish to get a simpler code or it can be caused by a superior goal of obtaining national or international harmonization of different codes. The calibration then is about assigning values to

the new code format such that the obtained code to the largest possible degree leads to the same structural dimensions as obtained by use of the existing and supposedly well functioning codes. Thus the calibration is based solely on comparative consequence calculations.

The highest level of code calibration consists of a best fit optimization aiming at approximating the results of a superior reliability analysis model. Several codes made since about 1975 are based on more or less extended principles of best fit optimization. The following sections describe one possibility of a procedure for optimal value assessment for a partial safety factor code format. The aim is to produce a code with a specified target value of the generalized reliability index for the structures that will be designed according to the rules of the code.

16.2 Formulation of code optimization

The formulation of a code optimization problem can be made in five steps. Possibly this five step formulation is both too simple and too rigid. It may not be a particularly precise description of the way a code optimization problem is formulated in practice. Neither it is a recipe for the formulation but rather to be considered as a crude schematic description of the most important components of the best fit code optimization procedure.

Structure class

The *first step* is to define the class of structures on which the code should operate. This definition may contain limitations, e.g. in geographical domains of validity of the code, failure modes, materials and geometric properties.

With the exception of well-defined physical or mathematical constants (e.g. the mass density of water or the acceleration of gravity) the numerical constants of a code can be considered as variables. With these variables taking values from some set of values, a set of different codes is obtained. This set of codes is the *code format* as defined in the previous section and the actual code is one of several possible realizations of the code format.

A code format can be more or less complicated. For example, it can consist of a specific set of characteristic values and a simple table of corresponding partial safety factors. Alternatively, more complicated partial safety factors can be given as functions of different cases (e.g. as different load factors for steel columns and beams or for different types of structures depending of the type and size of the risk related to a failure) or be defined implicitly in terms of mathematical expressions. Compared to what can be achieved by a simple code format, a complicated code format generally makes it possible to obtain structures that are closer to be optimal, that is, closer to satisfy the goal of the code. It is emphasized, however, that an accurate definition of the domain of the code is a necessity. A set of load factors that is best suited for a given technology is not necessarily best for another technology.

Goal of the code

The *second step* is to define the goal of the code. For a partial safety factor code format the goal can be the maximization of the expected utility as considered in Chapter 12, to obtain a specified failure probability, or to obtain a specified geometric or generalized reliability index. The goal is thus defined in terms of a reliability method on a higher level.

Importance weighting

The *third step* is to obtain information about the frequency of practical occurrence of different structural designs and related parameter values within the structural class defined in the first step. Since a code in general cannot be both simple and exactly satisfy the goal, it is necessary to define the most important structural data for which the goal should be satisfied as well as possible. For example, if most action effects in a cross-section are limited to the effects that correspond to a ratio between self weight and movable load that ranges from 1/2 to 2, it is generally possible to obtain a better fit for this restricted interval than for the entire load ratio interval from 0 to ∞ .

16.2.1 Measure of fit

The *fourth step* is to define a measure for the degree of fit between a code and the goal of the code. Consider the example where a probabilistic reliability analysis model has been formulated and the goal of the code is to have a given target value p_t of the failure probability with corresponding target reliability index $\beta_t = -\Phi^{-1}(p_t)$. Let β be the value of the reliability index for a design case within the class of structures of the code. Then the degree of fit between β and β_t can be measured by the difference between the expected total costs corresponding to β and β_t , respectively. In a simple way the expected total cost C_T can be written as, see Example 12.1,

$$C_T = C_I + C_F p \quad (16.2.1)$$

where p is the failure probability corresponding to β , C_I is the initial cost and C_F is the failure cost. The initial cost C_I can as in Example 12.1 be approximated by

$$C_I = a(1 + b\beta) \quad (16.2.2)$$

where a and b are constants for the individual structural part. The expected failure costs $C_F p$ can be approximated by

$$C_F p = C_F \Phi^{-1}(-\beta) \approx C_F c \exp\left(-\frac{\beta}{d}\right) \quad (16.2.3)$$

where c and d are constants of which c will be eliminated in the following. The value $d \approx 0.23$ gives a good approximation within a range of p from 10^{-6} to 10^{-3} . As a function of β the total expected cost can then be written as

$$C_T(\beta) = a(1 + b\beta) + C_F c \exp\left(-\frac{\beta}{d}\right) \quad (16.2.4)$$

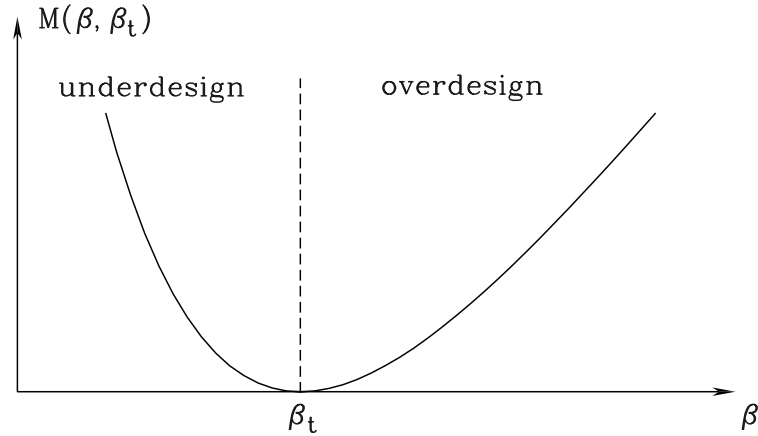

Figure 16.1: The penalty function defined by (16.2.6) to be used for code calibration with respect to the goal of achieving a target reliability index β_t .

According to the goal of the code (the optimality postulate, Chapter 12) this function takes its smallest value for $\beta = \beta_t$. From this it follows that

$$C_F = \frac{abd}{c} \exp\left(\frac{\beta_t}{d}\right) \quad (16.2.5)$$

such that

$$\frac{C_T(\beta) - C_T(\beta_t)}{abd} = \frac{\beta - \beta_t}{d} - 1 + \exp\left(-\frac{\beta - \beta_t}{d}\right) \quad (16.2.6)$$

The right side of (16.2.6) defines a function $M(\beta, \beta_t)$ which is proportional to the loss coming from the deviation of β from β_t . In the following such a function is called a *penalty function*. The graph of the right side of (16.2.6) is shown in Fig. 16.1.

The weighted average

$$\Delta = \sum_{\text{geographical domain}} \sum_{\text{materials}} \sum_{\text{failure modes}} \sum_{\text{parameters}} p_i M(\beta_i, \beta_{t,i}) \quad (16.2.7)$$

of the penalty function is a measure of the degree of fit between the code and its goal. The averaging is made over all structures within the class of the structures defined in the first step. The weights p_i are chosen on the basis of the relative frequencies determined in the third step under consideration of the variation with respect to the summation index i of the parameters a and b . These parameters determine the initial cost of the i th design case. The influence from a and b can be neglected if the monetary values of the structural elements do not vary essentially within the domain of the code. It is indicated in (16.2.7) by the index i that different values of the target value β_t may be actual. For example, this may be the case when different failure modes are considered. The code optimization hereafter consists in determination of the values of the variables in the code format such that Δ takes its smallest value. The optimization can also be made with restrictions like $\beta_i \geq \beta_{i,\min}$ where $\beta_{i,\min}$ is a specified smallest allowable value of the reliability index. Also some of the variable values may be chosen in advance.

It is seen from Fig. 16.1 that the penalty function defined by (16.2.6) is skewed such that underdesign gives a larger penalty than overdesign. A simpler penalty function without this skewness is the square of the deviation $\beta - \beta_t$. It turns out that the final result of the code optimization is not very sensitive to the choice of the penalty function.

Remark 16.1 If β_{opt} as given by (12.4.2) is taken as the target reliability index β_t for calibration of a design value code format, Section 16.3, the penalty function on the reliability index deviations from the target reliability index should ideally be such that it preserves the damage cost expectation $E[D]$. This suggests that the penalty function should be chosen such that it is a function of β solely through $\exp[\frac{1}{2}(\beta^2 - \beta_t^2)] - 1$ rather than through $\beta - \beta_t$. \square

An example of results from a code optimization comes from the calibration of the 1977-edition of the Canadian code for buildings. The chosen code format was

$$\varphi R \geq \begin{cases} 1.25 D + 1.50 L \\ 1.25 D + 0.70(1.50 L + 1.40 W) \end{cases} \quad (16.2.8)$$

where the capital letters symbolize characteristic values for strength R and load effects from dead load D , imposed load (live load) L and wind load W , and where φ is an unknown partial safety factor on the strength. The partial safety factors and the reduction factor for load effects were chosen in advance. The target reliability index values were

$$\beta_t = \begin{cases} 4.00 & \text{for collapse by yielding in tension or bending} \\ 4.75 & \text{for collapse by compression or by loss of stability} \\ 4.25 & \text{for collapse by shear} \end{cases} \quad (16.2.9)$$

These target reliability-index values were chosen on the basis of an analysis of structural elements designed according to the code actually in use. The penalty function was chosen as the square of $\beta - \beta_t$. The result of the optimization was

cold formed steel	yielding	$\varphi_1 = 0.90$
hot rolled steel	yielding	$\varphi_2 = 0.85$
	compression/instability	$\varphi_3 = 0.85$
reinforced concrete	bending	$\varphi_4 = 0.83$
	compression/instability	$\varphi_5 = 0.68$
	compression/instability	$\varphi_6 = 0.64$

A flow chart with the different steps of the calibration procedure is shown in Fig. 16.2.

Code format optimization

A *fifth step* may be taken doing a code optimization for each code format in a chosen sequence of code formats ordered with respect to increasing complexity. In general even the simplest goal

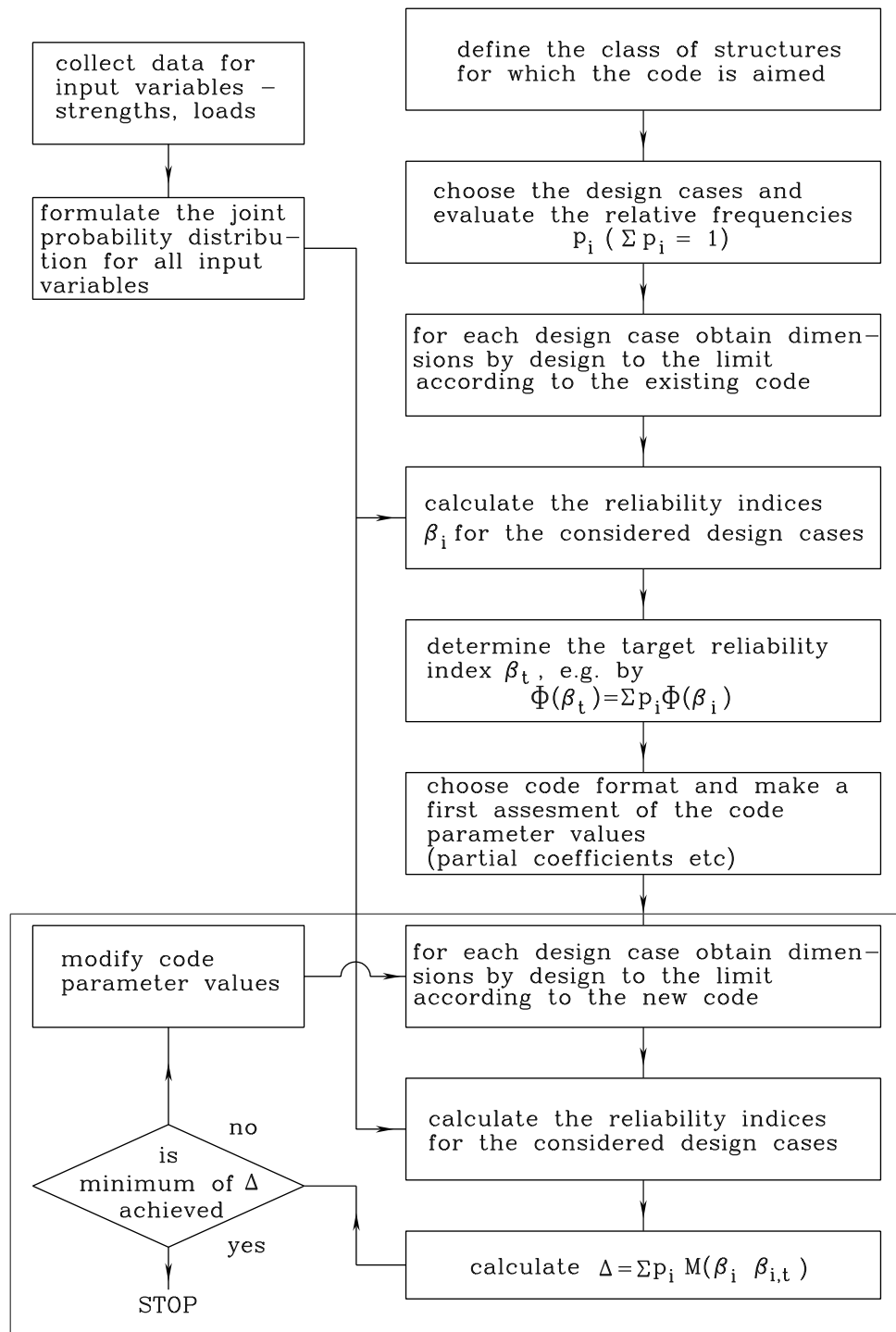

Figure 16.2: Flow chart for code optimization.

cannot be satisfied exactly by any chosen code format except possibly for code formats of an unacceptable level of complexity. Thus the search for a reasonable choice of a code must be

restricted to formats that lead to sufficiently simple design methods. In the obtained sequence of realizations of the code formats, a code is chosen on the basis of a compromise between simplicity and degree of fit to the goal.

According to [A1.1] such an optimization procedure has been applied to the British code for steel bridges BS 5400: Part 3. This code calibration example is described in detail in [A1.2,p.196].

16.3 Design-value format

The design-value format represents a code format which is well adapted to be calibrated with respect to the reliability-index method. The following considerations are based on single-point FORM (the geometric reliability index).

For an independent input variable X the relation between the design value x_d in the physical formulation space and the corresponding coordinate $\alpha\beta$ to the globally most central limit-state point in the standardized Gaussian space is determined by

$$F_X(x_d) = \Phi(\alpha\beta) \quad (16.3.1)$$

The design value x_d then is

$$x_d = F_X^{-1}[\Phi(\alpha\beta)] \quad (16.3.2)$$

For some common distributions of mean value μ and coefficient of variation V the result is

$$x_d = \begin{cases} \mu(1 + \alpha\beta V) & \text{normal distribution} \\ \mu \exp(\alpha\beta V - \frac{1}{2}V^2), \quad V^2 \ll 1 & \text{lognormal distribution} \\ \mu(1 - 0.78 V \{0.577 + \log[-\log \Phi(\alpha\beta)]\}) & \text{Gumbel distribution} \end{cases} \quad (16.3.3)$$

If the mean value μ is known, the design value can thus be determined by explicit consideration of distribution type F_X , coefficient of variation V , importance of uncertainty α and reliability level β .

For the possible design cases within the domain of a code the directional vector α for a given target reliability index β_t will vary from case to case. The situation is illustrated in two dimensions in Fig. 16.3 with two different limit states 1 and 2. The radius β of the circle defines the common reliability level. If this β is the target reliability level β_t , the value of the design variable (reinforcement area of a concrete beam cross-section, say) in the limit-state problem 1 is determined such that the limit-state curve 1 becomes tangential to the circle. For this particular design there are an infinity of partial safety factor pairs applied to given characteristic values for X_1 and X_2 , see Section 2.5. Clearly all what is needed is arbitrarily to define a single design point Q on the limit-state curve, given that the family of limit-state curves for the design situation 1 is a one-parameter family with the design variable as parameter. If D_1 is chosen as design point, where D_1 is the most central limit-state point, the partial safety factors, Section 2.4, that produce the same design become

$$\gamma_{11} = \frac{F_{X_1}^{-1}[\Phi(\alpha_{11}\beta_t)]}{x_1^c}, \quad \gamma_{12} = \frac{x_{2c}}{F_{X_2}^{-1}[\Phi(\alpha_{12}\beta_t)]} \quad (16.3.4)$$

where (in accordance with Fig. 16.3) x_1^c is an upper fractile characteristic value of X_1 (load type variable) and x_{2c} is a lower fractile characteristic value of X_2 (resistance type variable), e.g.

$$x_1^c = F_{X_1}^{-1}(p_1), \quad x_{2c} = F_{X_2}^{-1}(p_2) \quad (16.3.5)$$

with $p_1 = 0.98$, say, and $p_2 = 0.05$, say. For the other limit state 2 the point D_2 may be taken as design point and partial safety factors γ_{21}, γ_{22} .

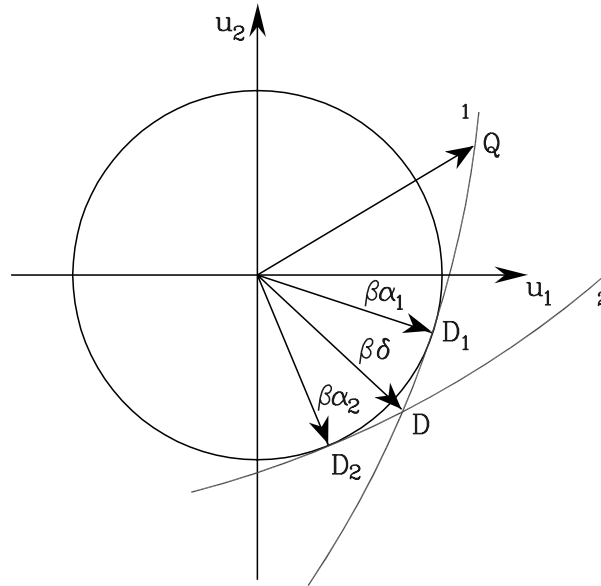

Figure 16.3: Exact replacement vector δ for two α -vectors α_1 and α_2 .

Needless to say, since the partial safety factor method serves a purpose only if it can be used directly for design without first making a design according to the reliability-index method, it is necessary that the partial safety factors be fixed at least within a reasonably wide class of design problems. For the case with the two limit states in Fig. 16.3 it is immediately seen that if the intersection point D between the two limit-state curves is taken as design point, then the partial safety factors are common for the two limit states. The vector δ acts as a replacement vector for α_1 and α_2 without introducing any error of approximation. Clearly, with more than two limit states in the class of design problems containing solely the two random variables X_1 and X_2 there is no replacement vector δ that exactly reproduces all the designs. By given superior requirement there will only be one design point $\beta\delta$ for the class, and all the limit-state curves are therefore adjusted to contain this point. Thus the reliability indices will vary over the class. The strategy is then to determine the replacement vector δ such that the expected loss (penalty) for the entire design class becomes minimal, that is, such that the function Δ in (16.3.7) is minimized. In this optimization problem it is not required that δ is a unit vector. By design "to the limit" in the i th design case the limit-state surface will, in stead of the equation $g_i(\mathbf{u}) = 0$, get an equation $\tilde{g}_i(\mathbf{u}) = 0$ which is satisfied for the point $\mathbf{u} = \beta_i\delta$. In general this point is not necessarily the same as, or even close to, the most central point on the surface $\tilde{g}_i(\mathbf{u}) = 0$.

The situation is illustrated in Fig. 16.4 . If the limit-state surfaces defined by $g_i(\mathbf{u}) = 0$ and $\tilde{g}_i(\mathbf{u}) = 0$ are almost plane and parallel within a domain that contains the points $\beta_t \alpha_i$, $\beta_t \delta$, $\beta_i \tilde{\alpha}_i$, then it follows directly from the figure that the geometric reliability index β_i is approximately

$$\beta_i \approx \beta_t \alpha_i^T \delta \tag{16.3.6}$$

The penalty function (16.3.6) can hereafter with sufficient accuracy be modified to

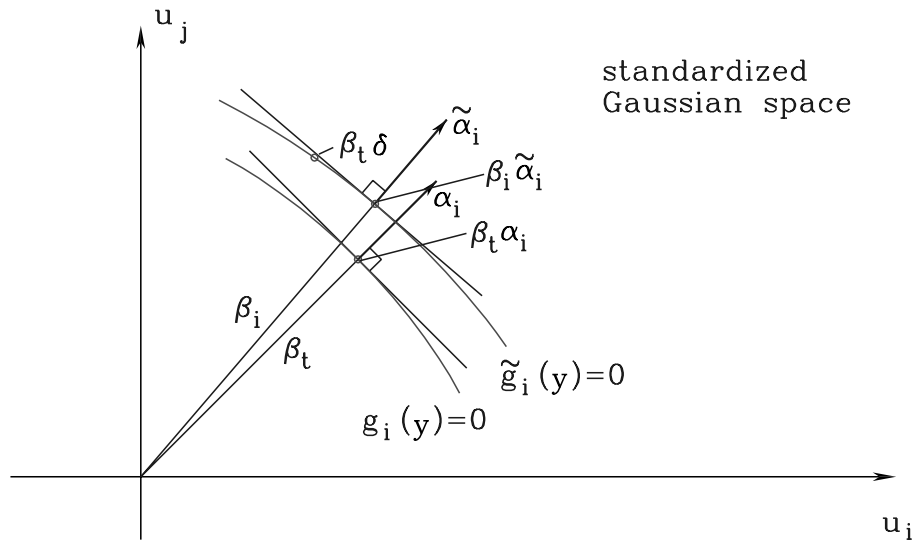

Figure 16.4: Illustration of limit-state surfaces and reliability indices for the i th design case in the optimization of a design value format with fixed replacement vector δ for direction vector α_i to the most central limit-state point.

$$M(\beta_i, \beta_t) = \frac{\beta_t(\alpha_i^T \delta - 1)}{d} - 1 + \exp\left(-\frac{\beta_t(\alpha_i^T \delta - 1)}{d}\right) \tag{16.3.7}$$

and the optimization of the weighted average Δ defined in (16.3.7) can be made. A flow chart for this optimization is shown in Fig. 16.4. Compared to the optimization in Fig. 16.2 a major computer time saving is gained because the box: “Determination of dimensions by design to the limit according to new code” due to (16.3.6) can be moved outside the optimization procedure. Thus it is only made once and the optimization can be made by a standard algorithm. Of course, the range of obtained reliability index values within the class should be controlled. If the range is judged to be too wide, the class should be divided into subclasses each with its own set of partial safety factors.

It should be noted that the obtained optimal replacement vector δ for α can be used with good accuracy for other specified values of β_t in the vicinity of the value used in the optimization. By a moderate change of the target reliability level it is therefore not necessary to make a new optimization as it is the case if the procedure of Fig. 16.2 is used.

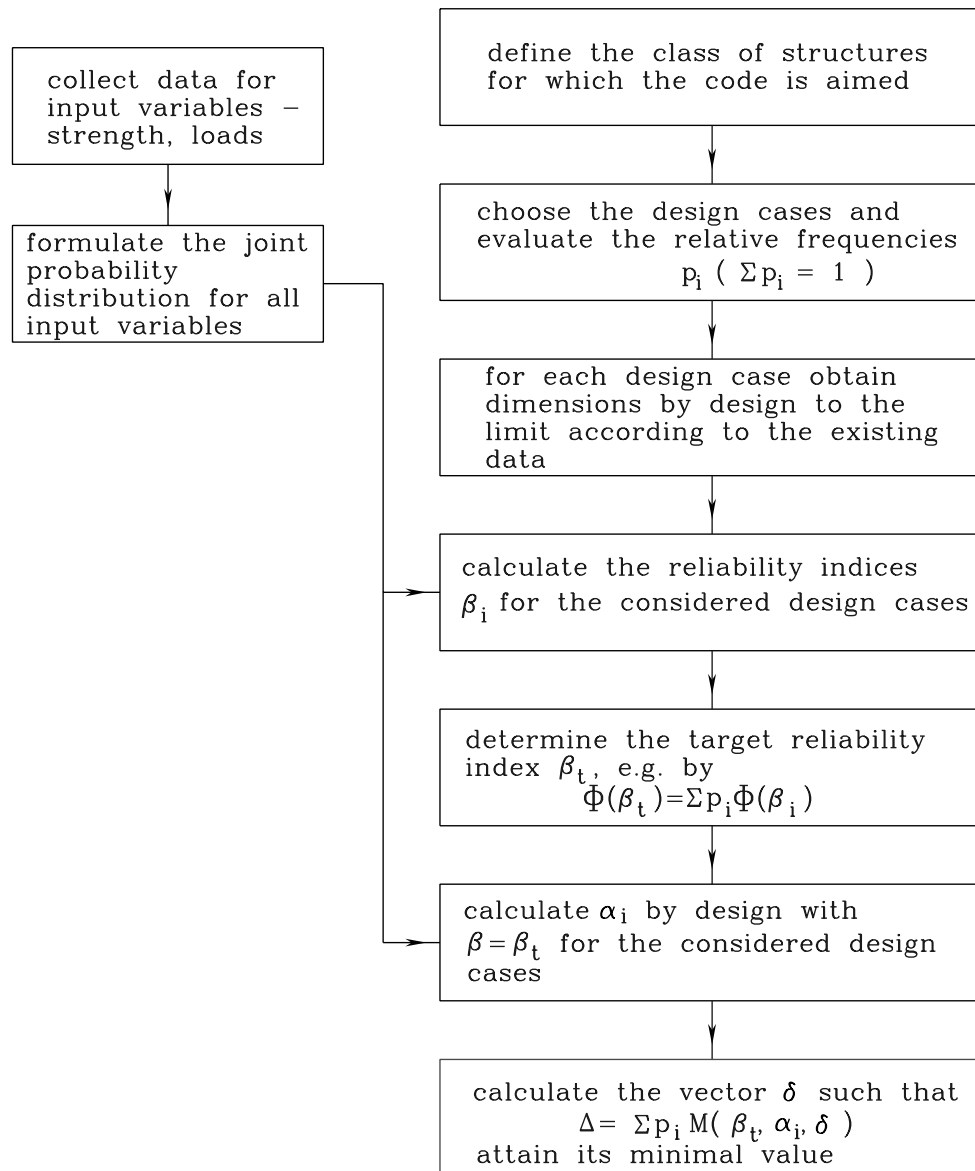

Figure 16.5: Flow chart for code optimization of design-value format.

Example 16.1 A rectangular cross-section of a reinforced concrete beam has in pure bending the yield moment

$$M_u = \left(1 - K \frac{A_s f_y}{b h_n \sigma'_c}\right) A_s f_y h_n \quad (16.3.8)$$

given that the cross-section is normally reinforced. A_s is the cross-section area of the reinforcement, f_y is the yield stress of the reinforcement, σ'_c is the compression failure stress of the concrete, b is the width of the cross-section, h_n is the effective height, and K is a factor that depends on the strain-stress curve of the concrete. For a linear-elastic strain-stress curve we have $K = 2/3$ while $K = 1/2$ for a rigid-ideal-plastic strain-stress curve.

The acting bending moment consists of a contribution M_g from the dead load and a contribution M_q from the live load such that the limit-state function in the physical formulation space is given by

$$G = M_u - M_g - M_q \quad (16.3.9)$$

Table 16.1 shows the uncertainty modeling for this example. Six different design cases are chosen corresponding to three values of the ratio between the mean values of M_g and M_q and two values of the coefficients of variation for M_q . The six design cases are assumed to occur with the same frequency, that is, $p_i = 1/6, i = 1, 2, \dots, 6$.

Parameter	Mean value	Coefficient of variation	Distribution type
M_g	25,75,25 kNm	0.07	normal
M_q	25,25,75 kNm	0.15,0.30	Gumbel
σ'_c	35 MPa	0.10	lognormal
f_y	485 MPa	0.06	normal
K	0.55	0.05	lognormal
b	0.25 m	-	fixed value
h_n	0.50 m	(A_s is the design variable)	fixed value
A_s	$6 \times 10^{-4} \text{ m}^2$	(h_n is the design variable)	fixed value

Table 16.1: Distributions for input parameters in bending failure model for normally reinforced concrete beam.

The target value of the reliability index is $\beta_t = 5.00$. For the six design cases the beam is designed such that $\beta = 5.00$. The design variable is first taken to be the reinforcement area A_s and $h_n = 0.50$ m. 16.2 shows the vector α for the six cases and the solution δ to the optimization problem.

$E[M_g]/E[M_q]$	V_{M_q}	M_g	M_q	σ'_c	f_y	K	
1/1	0.15	[0.11	0.92	-0.01	-0.38	0.01]	α_1^T
3/1	0.15	[0.34	0.72	-0.03	-0.60	0.02]	α_2^T
1/3	0.15	[0.04	0.95	-0.03	-0.29	0.01]	α_3^T
1/1	0.30	[0.06	0.96	-0.01	-0.27	0.01]	α_4^T
3/1	0.30	[0.17	0.91	-0.03	-0.37	0.01]	α_5^T
1/3	0.30	[0.02	0.98	-0.04	-0.22	0.02]	α_6^T
		[0.20	0.90	-0.04	-0.44	0.02]	δ^T

Table 16.2: Calculated sensitivities (that is, components of α) for each of the 6 design cases for a reinforced concrete section and all with the reliability index $\beta = 5.00$. The last row shows the optimal replacement vector δ .

The design values for the individual input parameters are next calculated by use of (16.3.2) and (16.3.3) substituting the relevant coordinate of $\beta_t \delta$ for $\beta \alpha$. The design values become:

$M_{gd} = 1.07 E[M_g]$, $M_{qd} = 2.41 (3.81) E[M_q]$ for $V_{M_q} = 0.15 (0.30)$, respectively, $\sigma'_{cd} = 0.98 E[\sigma'_{cd}]$, $f_{yd} = 0.87 E[f_y]$, $K_d = 1.004 E[K]$. If the characteristic value for M_q is the 98%-fractile, it is $1389 (1778) E[M_q]$ for $V_{M_q} = 0.15 (0.30)$, respectively. The corresponding partial safety factors thus become 1.74 (2.14), respectively.

Next the beam is designed on the basis of these design values. The design parameter A_s is determined as

$$A_s = \frac{h_n \pm \sqrt{h_n^2 - 4K(M_{gd} + M_{qd})/(b\sigma'_{cd})}}{2Kf_{yd}/(b\sigma'_{cd})} \quad (16.3.10)$$

The values of the reliability index for the resulting cross-sections are shown in Table 16.3. It is seen that there is a good fit to the target value $\beta_t = 5.00$ by the values obtained from use of the optimal replacement vector δ given in Table 16.2. This replacement vector for α has also been applied upon a change of the target reliability index to $\beta_t = 3.00$. New design values are calculated by use of (16.3.3) and the reliability index values for the resulting cross-sections are given in Table 16.3. It is seen that there is a good fit between the target and the calculated values even though the optimal replacement vector δ is determined for $\beta_t = 5.00$.

$E[M_g]/E[M_q]$	V_{M_q}	$\beta(\beta_t = 5.00)$	$\beta(\beta_t = 3.00)$
1/1	0.15	5.10	3.08
3/1	0.15	5.01	2.83
1/3	0.15	5.01	3.02
1/1	0.30	5.00	3.01
3/1	0.30	5.12	3.07
1/3	0.30	4.92	2.95

Table 16.3: Resulting reliability indices for each of six design cases of the steel area in reinforced concrete beam cross-section for a fixed replacement vector δ determined to be optimal for $\beta_t = 5.00$.

Calculations with the effective height h_n as design parameter have also been made with $A_s = 6 \times 10^{-4} \text{ m}^2$. A table like Table 16.2 is produced and the optimal replacement vector δ is obtained as $\delta' = [0.18 \ 0.89 \ -0.02 \ -0.47 \ -0.01]$. It is seen not to deviate much from the replacement vector obtained in Table 16.2 where A_s is the design variable.

The effective height is determined from the obtained design values as

$$h_n = \frac{M_{gd} + M_{qd}}{A_s f_{yd}} + \frac{K A_s f_{yd}}{b\sigma'_{cd}} \quad (16.3.11)$$

Table 16.4 in analogy with Table 16.3 gives the values for the resulting reliability index for the same two values of the target reliability index as for the case of A_s as design variable.

□

There is a particularly important issue related to the classification of design problems into classes of constant partial safety factors. For limit states of the same mechanical type (same collapse mode) the α -vectors as defined in Fig. 16.3 tend to be close to each other such that the

$E[M_g]/E[M_q]$	V_{M_q}	$\beta(\beta_t = 5.00)$	$\beta(\beta_t = 3.00)$
1/1	0.15	5.00	3.07
3/1	0.15	5.01	2.84
1/3	0.15	5.01	3.02
1/1	0.30	4.99	3.00
3/1	0.30	5.11	3.06
1/3	0.30	4.93	2.94

Table 16.4: Resulting reliability indices for each of six design cases of the effective height of a reinforced concrete beam cross-section for a fixed replacement vector δ determined to be optimal for $\beta_t = 5.00$.

corresponding most central points form a cluster on the sphere of radius β_t (in Fig. 16.3 the points D_1 and D_2 on the circle of radius β). As an example consider reinforced concrete, and in particular consider, as one type, the bending failure of a beam cross-section where the yield moment is mainly determined by the yield strength X_1 of the tension reinforcement and, as another type, the compression failure of a short column where the carrying capacity is mainly determined by the compression strength X_2 of the concrete. Then the situation in the (u_1, u_2) -plane is as sketched in Fig. 16.6. For the bending failure limit states the variability of X_2 has only small influence and the cluster of most central limit-state points is therefore situated on the vicinity of $(-\beta, 0)$. For the limit states of compression failure type the cluster of most central limit-state points is similarly situated on the circle in the vicinity of $(0, -\beta)$, about 90° apart from the first cluster of points. If the two limit-state types are put in two different design-case classes we get the two optimal replacement vectors δ_1 and δ_2 centrally placed within each cluster, as illustrated in Fig. 16.6. If both types of limit states are required to be treated by the same partial safety factors, that is, if they are put together in one class, the optimal replacement vector δ will have some direction between the two clusters depending on the relative weighting of the two types. In the final steps of the iterative optimization procedure to obtain δ the approximation (16.3.6), and thus the penalty function (16.3.7), may not be sufficiently accurate. Fig. 16.6 (left) shows two limit states of each type. With equal weight on the two types a first crude assessment of an optimal δ is obtained by letting $\beta\delta$ be the vector to the crossing point of the two orthogonals to δ_1 and δ_2 at the points $\beta\delta_1$ and $\beta\delta_2$, respectively.

Fig. 16.6 (right) illustrates the possible consequence of having a single replacement vector δ for the α -vectors of about 90° separated clusters of most central limit-state points. All the limit states are now required to contain the point $\beta\delta$ with $\beta = \beta_t$. Obviously the approximation errors for the reliability indices increase when extending the class of design cases. What intuitively can be seen from Fig. 16.6 (right) is that from having quite small approximation errors when keeping δ_1 and δ_2 for practical design, the error may blow up to considerable size when requiring that there should only be one set of partial safety factors.

Whether the minor complication of having some few classes of partial safety factors is of sufficient inconvenience to justify the resulting much larger reliability variability when there is only a single class, can in principle be decided in a rational way by a cost benefit analysis. At the very least it must be ensured that there within the class is no relevant structures for which the reliability index becomes much smaller than the target reliability index.

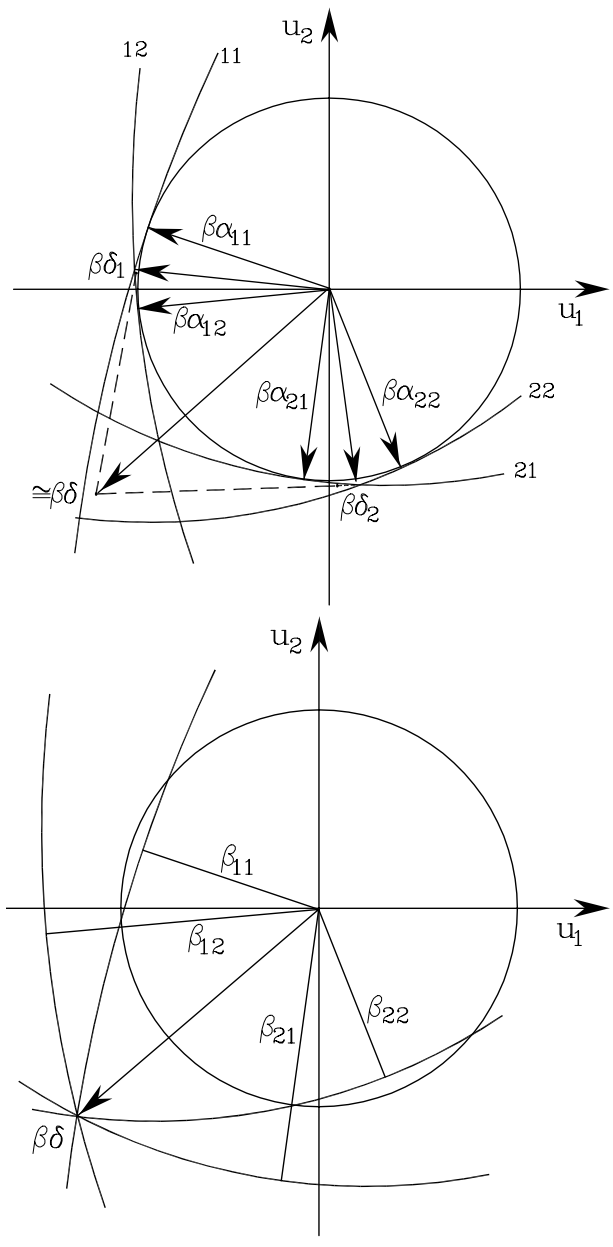

Figure 16.6: Illustration of effect of using replacement vector

16.4 Sensitivity of the replacement vector δ in the design-value format*

Under the approximation $\beta_i \approx \beta_t \alpha_i^\top \delta$, (16.3.6), any twice differentiable penalty function defined as a function of $\beta_i - \beta_t$ becomes some function $h(\alpha_i^\top \delta)$ solely of the scalar product $\alpha_i^\top \delta$ such that $h(1) = h'(1) = 0$, $h''(1) > 0$. Then Δ in (16.3.7) may be written as

$$\Delta = \sum_i p_i h(\alpha_i^\top \delta) \quad (16.4.1)$$

and the optimal replacement vector δ is obtained as the solution to the n equations $\partial\Delta/\partial\delta_1 = \dots = \partial\Delta/\partial\delta_n = 0$. Written together on vector form these n equations become

$$\sum_i p_i h'(\alpha_i^\top \delta) \alpha_i = \mathbf{0} \quad (16.4.2)$$

The sensitivity of the optimal δ with respect to some parameter θ is now obtained through implicit differentiation by interpreting (16.4.2) as an identity with respect to θ . Thus we get

$$\sum_i p_i \left[h''(\alpha_i^\top \delta) \left(\frac{d\alpha_i^\top}{d\theta} \delta + \alpha_i^\top \frac{d\delta}{d\theta} \right) \alpha_i + h'(\alpha_i^\top \delta) \frac{d\alpha_i}{d\theta} \right] = \mathbf{0} \quad (16.4.3)$$

assuming that the weights p_i are independent of θ .

The solution of (16.4.3) with respect to $d\delta/d\theta$ becomes

$$\frac{d\delta}{d\theta} = - \left[\sum_i p_i h''(\alpha_i^\top \delta) \alpha_i \alpha_i^\top \right]^{-1} \sum_i p_i \left[h''(\alpha_i^\top \delta) \alpha_i \delta^\top + h'(\alpha_i^\top \delta) \mathbf{I} \right] \frac{d\alpha_i}{d\theta} \quad (16.4.4)$$

The sensitivity $d\alpha_i/d\theta$ is given by (8.2.25) for $\beta = \beta_i$, $g = g_i$.

16.5 Sensitivity of the partial safety factors in the design-value format*

Let x_{dj} be the design value corresponding to the component δ_j of the replacement vector δ , and let x_{cj} be the characteristic value of the random variable X_j . In the following we simplify the writing by omitting index j . Then

$$x_d = F_X^{-1}[\Phi(\beta_t \delta); \theta] \quad (16.5.1)$$

$$x_c = F_X^{-1}[\Phi(p); \theta] \quad (16.5.2)$$

explicitly indicating the possibility that the distribution of X depends on the parameter θ . Then the derivative of the partial safety factor $\gamma = x_d/x_c$ with respect to θ becomes

$$\begin{aligned} \frac{d\gamma}{d\theta} &= \frac{1}{x_c^2} \left(x_c \frac{dx_d}{d\theta} - x_d \frac{dx_c}{d\theta} \right) \\ &= \frac{1}{x_c^2} \left\{ \frac{x_c}{f_X(x_d; \theta)} \left[\varphi(\beta_t \delta) \beta_t \frac{d\delta}{d\theta} - \frac{\partial}{\partial \theta} F_X(x_d; \theta) \right] + \frac{x_d}{f_X(x_c; \theta)} \frac{\partial}{\partial \theta} F_X(x_d; \theta) \right\} \end{aligned} \quad (16.5.3)$$

For $\gamma = x_c/x_d$ the derivative $d\gamma/d\theta$ is obtained from (16.5.3) by replacing the left side by $d(1/\gamma)/d\theta$. The derivative $d\delta/d\theta$ is the j th component of $d\delta/d\theta$ given by (16.4.4).

Bibliography

[A1.1] A.R. Flint, B.W. Smith, M.J. Baker, and W. Manners (1981) The derivation of safety factors for design of highway bridges. *Proc. Conf. on the New Code for the Design of Steel Bridges*, Cardiff 1980. Granada Publishing.

[A1.2] P. Thoft-Christensen and M.J. Baker (1982) *Structural Reliability Theory and its Applications*. Springer-Verlag, Berlin, Heidelberg, New York.

Chapter 17

Appendix 2: NATAF DISTRIBUTION

17.1 Correlation coefficients in Nataf distribution

The ratio $R = \rho_{ij}/r_{ij}$ of the correlation coefficients in (7.2.9) to be used for defining the Nataf distribution can be determined exactly or approximately by solving the equation (7.2.6) with respect to ρ_{ij} for given $r_{ij} = r$. The following tables give the results that are obtained from [7.2]. The tables are set up with reference to a categorization of the considered marginal distribution types into two categories. The first category consists of those distribution types that by a suitable transformation of the random variable can be given a parameter-free standard form. The second category consists of those distribution types that are not of the first category. All the considered distributional types are listed in Tables 17.1 and 17.2.

Among the possible pairs of distribution types there are two for which R is given explicitly. These are (see distribution class symbols in Table 17.1 and 17.2):

$$(X_i, X_j) \in (N, LN) : R = \frac{V_j}{\sqrt{\log(1 + V_j^2)}} \quad (17.1.1)$$

$$(X_i, X_j) \in (LN, LN) : R = \frac{\log(1 + r V_i V_j)}{r \sqrt{\log(1 + V_i^2) \log(1 + V_j^2)}} \quad (17.1.2)$$

The ratio R is independent of r if $X_i \in N$. Under this assumption, Table 17.3 lists the values of R when X_j has a distribution of the first category. Table 17.4 lists the coefficients of 1, V_j and V_j^2 , respectively, of a linear combination that approximates R . The error of this approximation is bounded as indicated in the table given that $0.1 \leq V_j \leq 0.5$.

The other cases of combinations of distributional types into pairs are given in the Tables 17.5, 17.6 and 17.7, which are all self-explanatory. The intervals for V_i and V_j are in all cases from 0.1 to 0.5.

The allowable domain of variation for the correlation matrix $\{r_{ij}\}$ depends on the dimension of the corresponding multidimensional distribution. The Nataf distribution is only definable if the solutions to the equation (7.2.6) define a positive definite matrix $\{\rho_{ij}\}$.

Name (symbol)	Distribution function	Standard parameter-free distribution function
normal (Gauss) (N)	$\Phi\left(\frac{x-\mu}{\sigma}\right)$	$\Phi(y)$
uniform (U)	$\frac{x-a}{b-a}, x \in [a, b]$	$y, y \in [0, 1]$
shifted exponential (SE)	$1 - \exp[-\lambda(x-a)]$ $x \in [a, \infty[$	$1 - e^{-y}$ $y \in [0, \infty[$
shifted Rayleigh (SR)	$1 - \exp\left[-\frac{1}{2}\left(\frac{x-a}{\alpha}\right)^2\right]$ $x \in [a, \infty[$	$1 - \exp\left(-\frac{1}{2}y^2\right)$ $y \in [0, \infty[$
Gumbel (type I) largest value (GL)	$\exp\{\exp[-\alpha(x-a)]\}$	$e^{e^{-y}}$
Gumbel (type I) smallest value (GL)	$1 - \exp\{\exp[-\alpha(x-a)]\}$	$1 - e^{e^{-y}}$

Table 17.1: Distributions of the first category

Name (symbol)	Distribution function
lognormal (LN)	$\Phi\left(\frac{\log x - \lambda}{\zeta}\right), x \in \mathbb{R}_+$
gamma (Γ)	$\frac{\Gamma(k, \lambda x)}{\Gamma(k)}, x \in [0, \infty[$ $\Gamma(k, x) = \int_0^x u^{k-1} e^{-u} du, \Gamma(k) = \Gamma(k, \infty)$
Fréchet (type II) largest value (F)	$\exp\left[-\left(\frac{a}{x}\right)^k\right], x \in \mathbb{R}_+$
Weibull (type III) smallest value (W)	$1 - \exp\left[-\left(\frac{x-a}{b-a}\right)^k\right], x \in [a, \infty[$

Table 17.2: Distributions of the second category

For the two-dimensional Nataf distribution with marginal distributions of the first category the allowable variation intervals for r are shown in Table 17.8. For distributions of the second category the allowable variation intervals depend on V_i and V_j but similarly wide intervals are obtained.

(X_i, X_j)	(N,U)	(N,SE)	(N,SR)	(N,GL)	(N,GS)	max error %
R	1.023	1.107	1.014	1.031	1.031	0.0

Table 17.3: Values of R for X_i normal and X_j of the first category

(X_i, X_j)	1	V	V^2	max error %
(N, Γ)	1.001	-0.007	0.118	0.0
(N,F)	1.030	0.238	0.364	0.1
(N,W)	1.031	-0.195	0.328	0.1

Table 17.4: Coefficients of 1, V , V^2 in a linear combination of 1, V , V^2 that approximates R . $V = V_j$.

(X_i, X_j)	1	r	r^2	max error %
(U,U)	1.047	-	-0.047	0.0
(U,SE)	1.133	-	0.029	0.0
(U,SR)	1.038	-	-0.008	0.0
(U,GL)	1.055	-	0.015	0.0
(U,GS)	1.055	-	0.015	0.0
(SE,SE)	1.229	-0.367	0.153	1.5
(SE,SR)	1.123	-0.100	0.021	0.1
(SE,GL)	1.142	-0.154	0.031	0.2
(SE,GS)	1.142	0.154	0.031	0.2
(SR,SR)	1.028	-0.029	-	0.0
(SR,GL)	1.046	-0.045	0.006	0.0
(SR,GS)	1.046	0.045	0.006	0.0
(GL,GL)	1.064	-0.069	0.005	0.0
(GL,GS)	1.064	0.069	0.005	0.0
(GS,GS)	1.064	-0.069	0.005	0.0

Table 17.5: Coefficients of 1, r , r^2 in the linear combination of 1, r , r^2 that approximates R .

(X_i, X_j)	(U, LN)	(SE, LN)	(SR, LN)	(GL, LN)	(GS, LN)
1	1.019	1.098	1.011	1.029	1.029
r	-	0.003	0.001	0.001	-0.001
r^2	0.010	0.025	0.004	0.004	0.004
V	0.014	0.019	0.014	0.014	0.014
V^2	0.249	0.303	0.231	0.233	0.233
rV	-	-0.437	-0.130	-0.197	0.197
max error %	0.7	1.6	0.4	0.3	0.3
(X_i, X_j)	(U, Γ)	(SE, Γ)	(SR, Γ)	(GL, Γ)	(GS, Γ)
1	1.023	1.104	1.014	1.031	1.031
r	-	0.003	0.001	0.001	-0.001
r^2	0.002	0.014	0.002	0.003	0.003
V	-0.007	-0.008	-0.007	-0.007	-0.007
V^2	0.127	0.173	0.12	0.131	0.131
rV	-	-0.296	-0.090	-0.132	0.132
max error %	0.1	0.9	0.9	0.3	0.3
(X_i, X_j)	(U, F)	(SE, F)	(SR, F)	(GL, F)	(GS, F)
1	1.033	1.109	1.036	1.056	1.056
r	-	-0.152	-0.038	-0.060	0.060
r^2	0.074	0.130	0.028	0.020	0.020
V	0.305	0.361	0.266	0.263	0.263
V^2	0.405	0.455	0.383	0.383	0.383
rV	-	-0.728	-0.229	-0.332	0.332
max error %	2.1	4.5	1.2	1.0	1.0
(X_i, X_j)	(U, W)	(SE, W)	(SR, W)	(GL, W)	(GS, W)
1	1.061	1.147	1.047	1.064	1.064
r	-	0.145	0.042	0.065	-0.065
r^2	-0.005	0.010	-	0.003	0.003
V	-0.237	-0.271	-0.212	-0.210	-0.210
V^2	0.379	0.459	0.353	0.356	0.356
rV	-	-0.467	-0.136	-0.211	0.211
max error %	0.5	0.4	0.2	0.2	0.2

Table 17.6: Coefficients of $1, r, r^2, V, V^2, rV$ in the linear combination of these parameters that approximates R for X_i of the first category and X_j of the second category. $V = V_j$.

(X_i, X_j)	(LN,GM)	(LN,F)	(LN,W)	(GM,GM)	(GM,F)	(GM,W)	(F,F)	(F,W)	(W,W)
1	1.001	1.026	1.031	1.002	1.029	1.032	1.086	1.065	1.063
r	0.033	0.082	0.052	0.022	0.056	0.034	0.054	0.146	-0.004
r^2	0.002	0.018	0.002	0.001	0.012	-	-0.055	0.013	-0.001
r^3	-	-	-	-	-	-	-0.020	-	-
V_i	0.004	-0.019	0.011	-0.012	-0.030	-0.007	0.104	0.241	-0.200
V_i^2	0.223	0.288	0.220	0.125	0.174	0.121	0.662	0.372	0.337
V_j	-0.016	0.222	-0.210	-0.012	0.225	-0.202	0.104	-0.259	-0.200
V_j^2	0.130	0.379	0.350	0.125	0.379	0.339	0.662	0.435	0.337
rV_i	-0.104	-0.441	0.005	-0.077	-0.313	-0.006	-0.570	0.005	0.007
rV_j	-0.441	-0.277	-0.174	-0.077	-0.182	-0.111	-0.570	-0.481	0.007
V_iV_j	0.029	0.126	0.009	0.014	0.075	0.003	0.203	0.034	-0.007
$V_i^3+V_j^3$	-	-	-	-	-	-	-0.218	-	-
$r(V_i^2+V_j^2)$	-	-	-	-	-	-	-0.371	-	-
$r^2(V_i+V_j)$	-	-	-	-	-	-	0.257	-	-
$V_iV_j(V_i+V_j)$	-	-	-	-	-	-	0.141	-	-
max error %	4.0	4.3	2.4	4.0	4.2	4.0	4.3	3.8	2.6

Table 17.7: Coefficients in linear combinations of the variables listed in the first column of the table. Each column defines a linear combination that approximates R with both X_i and X_j of the second category as indicated in the first row.

Distribution	N	U	SE
N	-1.000/1.000	-0.977/0.977	-0.903/0.903
U	-0.977/0.977	-0.999/0.999	-0.886/0.886
SE	-0.903/0.903	-0.866/0.866	-0.645/1.000
SR	-0.986/0.986	-0.970/0.970	-0.819/0.957
GL	-0.969/0.969	-0.936/0.936	-0.780/0.981
GS	-0.969/0.969	-0.936/0.936	-0.981/0.780
distribution	SR	GL	GS
N	-0.986/0.986	-0.969/0.969	-0.969/0.969
U	-0.970/0.970	-0.936/0.936	-0.936/0.936
SE	-0.819/0.957	-0.780/0.981	-0.981/0.780
SR	-0.947/1.000	-0.915/0.993	-0.993/0.915
GL	-0.915/0.993	-0.886/1.000	-1.000/0.886
GS	-0.983/0.915	-1.000/0.886	-0.886/1.000

Table 17.8: Variation intervals for the correlation coefficient r in the two-dimensional Nataf distribution when both marginal distributions are of the first category.

This page is intentionally left blank.

Chapter 18

Appendix 3: PROPOSAL FOR A CODE FOR THE DIRECT USE OF RELIABILITY METHODS IN STRUCTURAL DESIGN

Reprint of Working Document of November 1989 of the JOINT COMMITTEE ON STRUCTURAL SAFETY (Associations supporting the JCSS: CEB, CIB, ECCS, FIP, IABSE, IASS, RILEM, authored by O. Ditlevsen and H.O. Madsen)

Introduction

This is the first document of an envisaged series of publications, prepared by individual authors but discussed within the Joint Committee on Structural Safety (JCSS), in particular within its Working Party. They are referred to as "working documents" since they generally will give information on the state of development of certain concepts or subjects, rather than giving approved guidelines. Where a document is officially approved by the Plenum of the JCSS, this will be identified explicitly.

This document is a first step towards a code for direct use of reliability methods in design. Previous JCSS documents as, for example the "General Principles on Reliability for Structural Design" also published by IABSE, were mainly concerned with providing the background for a reliability based code. It is the general opinion of the JCSS Working Party, that reliability methods have advanced to an extent, that they may not only be used for deriving safety provisions in codes. A design which utilizes the full statistical information available and the advantages of a direct probabilistic modelling is possible - if only relevant for - special situations. These special situations may arise, for example, where a major part of the design information needs to be updated to account for specific conditions of the project or where detailed failure analyses are required.

It is well understood, that this type of code will never replace present (deterministic or reliability-based) codes. However, it may serve as a fundamental code which is supplemented by codes giving

rules for common design.

With this document it is intended to show, how a code for direct use of reliability methods may look like. Main emphasis is given on identifying those conventions and models which need to be codified. It is far from being a complete proposal. In the present form the document addresses reliability experts only, i.e. - as a potential code - it does not intend to promote the general understanding of reliability concepts. This issue may be disputable.

This document has been discussed within the JCSS Working Party and the basic ideas and concepts are approved. Some details of modelling, e.g. concerning model uncertainties and numerical values, in particular for safety indices, mainly reflect the opinion of the authors. Also, the terminology and some conceptual details are still under discussion.

Irrespective of these reservations, publication is supported in order to initiate discussions and exchange of comments at an early stage. The document will be revised subsequently.

Marita Kersken-Bradley
for the Working Party

Julio Ferry Borges
(General Reporter of the JCSS) (President of the JCSS)

1 Preface

When making considerations about structural safety it is essential to appreciate that a measure of safety based on a general probabilistic model in general does not express a pure physical property of the structure in its environments of actions. Rather the safety measure is a decision variable that embraces the applied knowledge about the strength properties of the structure in relation to the actions on the structure. The value of the safety measure therefore may change in both directions with the amount and quality of the information on basis of which it is calculated.

With this philosophy in mind the structural reliability theory becomes a design decision tool based on scientific methods rather than being a scientific theory itself aiming at a description of the "truth of nature". It may be looked upon as a formal language of rational thinking to facilitate good engineering decisions in the process of the design of structures. It should contain several formal elements and mathematical composition rules to allow for inclusion of all sorts of relevant information of sufficient confidence to let it effect the decisions. On the other hand, it should not be too rich of elements forcing the user of this reliability theory to make almost non-verifiable value assignments to which the design decisions are unreasonably sensitive. The consequence is that reliability theories for codes of practice should contain certain restrictive standardized value assignments.

In this context "code of practice" means a model universe agreed upon as a basis for design decisions. This agreement is thought of as made within the group of parties of concern (e.g. the designer, the manufacturer, the owner, the user, the last two parties possibly being represented by the public authorities). The code of practice may in this sense be specific for a given project, or it may be more general as a part of public building regulations. Thus the terminology "code of practice" as applied herein is an abstraction that should not be tied to existing types of codes of

practice. In the same spirit the term “code committee” should be interpreted as the group of parties agreeing on a code of practice.

The following text aims at presenting an example (a model) of a code of practice enabling reliability methods for design. The code text is indented. It is given in parallel with an explanatory text, which is not indented. The latter does not have the status of a code. The terminology has been discussed within the JCSS-Working Party but general agreement has not been reached. The terminology is therefore up to revision.

2 General

It is a fundamental requirement of this code that the reliability measure is relative in the sense that it induces an ordering of any set of structures according to their reliability with respect to any well-defined adverse event. Furthermore, for each structure it is required that the measure induces an ordering of any set of adverse events. It must even possess sufficient generality to allow for an ordering of any set of pairs: (structure, adverse event).

A reliability ordering relation like

$$(\text{structure 1, adverse event 1}) < (\text{structure 2, adverse event 2})$$

may be needed for different types of structures for which the adverse events are not the same.

The question of whether there is an absolute interpretation of the reliability measure is less important for the applications. Often there is no direct physical relative frequency interpretation related to the measure. Rather such an interpretation is related to the relative frequency of no adverse event occurring in the consistent long run use of the reliability analysis methodology in the absence of gross errors (mistakes).

This code allows for design on the basis of a reliability measure that deviates from the reliability measure defined herein provided it is within the scope of probability theory and well-documented by scientific methods and arguments.

If the reliability requirement is given in terms of a value of the reliability measure of this code, but an alternative reliability measure is used for the design decisions, a corresponding transformation of the requirement must be made. This transformation must be such that the alternative reliability measure when meeting the requirement leads to at least the same structural dimensions as obtained by use of the code reliability measure when both measures are applied on a sufficiently representative example structure.

Further details on reliability requirements are given in Section 6.

3 Concept of adverse state

The structural performance of a whole structure or part of it should be described with reference to a specified set of adverse states beyond which the structure no longer satisfies the performance requirements. Each adverse state is the boundary of an adverse event declared to be so by the committee setting up the performance requirement. A binary description of the performance is inherent in the adverse event concept.

Examples of adverse events are:

- loss of static equilibrium of the structure, or a part of the structure, considered as a rigid body,
- rupture of critical sections of the structure caused by exceeding the ultimate strength, possibly reduced by repeated loading, or the ultimate deformation of the material,
- transformation of the structure into a mechanism,
- loss of stability,
- progressive collapse,
- deformations which affect the efficient use or appearance of structural or non-structural elements,
- excessive vibrations producing discomfort or affecting non-structural elements or equipment,
- local damage, including cracking, which reduces the durability of a structure or affects the efficiency or appearance of structural or non-structural elements.

4 Basic variables and uncertainty modelling

The uncertainties of the mechanical models and their parameters as used in the process of making decisions are represented in terms of concepts from the mathematical probability theory.

Among the parameters of relevance some are presented as being basic variables in the sense that they are assumed to carry the entire input information to the mechanical model.

Typically the basic variables are material parameters, external action parameters, and geometric parameters. All other parameters are functions of these basic variables. The functions are defined by the geometric properties of the structure, the action model and the mechanical model. Typically they are cross-section resistances, member buckling resistances, load effects, areas, volumes, safety margins, event margins, etc.

In the simplest case of modeling the basic variables may be joined into a finite-dimensional vector. Then the uncertainties of the problem is modeled by letting this vector, or a subvector of it, be a vector of random variables.

The concept of basic variables should not be confused with the probabilistic concept of mutual independent random variables. The basic variables are defined as the free input variables in the mechanical model before the probabilistic properties are defined. (In the standard mathematical analysis these variables are called the independent variables while a function of the independent variables is called the dependent variable).

The imposed probabilistic properties may imply that there is mutual stochastic dependence between the basic variables after these have been declared to be random variables. An example of a pair of basic variables is the compressive strength and the modulus of elasticity at zero stress both measured on the same concrete test cylinder. Usually these two basic variables, when considered to be random variables, are modeled as being mutually dependent.

Within given classes of structural design problems the joint distribution types of the basic random variables are standardized in the code. These standardizations are defined in subsequent sections either directly in distributional terms or in terms of one-to-one transformations into Gaussian random variables.

Basic variables may more generally be functions in time and space. The action history within a given time interval is an example of a basic variable. Also such functions may be uncertain. The corresponding probabilistic concept is that of a random process or a random field.

If the mechanical model contains input variables which represent outputs from other mechanical models the joint distribution type of these input variables must be consistent with the standardized distribution types of the code after these have been transformed by the latter models.

If some input variables represent information from prototype testing the joint distributional type of these variables must follow from a mechanical model of the prototype test. This model relates the test results to the relevant basic variables for which the code gives distribution type specifications. Statistical uncertainty should be taken into account in this deduction (see below).

Uncertainties from all essential sources must be evaluated and integrated into the reliability model. Types of uncertainty to be taken into account are physical (intrinsic) uncertainty, statistical uncertainty, and model uncertainty.

Physical uncertainty is the ubiquitous background randomness the level of which may or may not be controlled by active means. Statistical uncertainty is due to limited information as it is provided by a sample of finite size. Model uncertainty is due to the necessary idealizations on which the physical model formulation and the distributional model formulation are based. The corresponding errors are more or less unknown. This type of uncertainty may for each adverse event be described as uncertainty of the corresponding adverse state surface.

Statistical uncertainty. If the design decisions are based on a small sample of observations of a basic variable (or a function of basic variables such as for prototype testing), statistical uncertainty must be quantified in the decision model as follows. By use of a well-documented natural conjugate prior distribution to the standardized distribution type of the actual random variable or, if a natural conjugate distribution does not exist, by use of a prior of mathematical form as the posterior, or by use of a non-informative prior, a predictive posterior distribution is calculated. This distribution must be applied in the reliability analysis.

The prior distribution is a probabilistic model of the knowledge about the parameters of the distribution of the considered random variable (or vector) X before some new independent data are available (usually in the form of an outcome of the vector (X_1, \dots, X_n) with all X_i mutually independent and distributed like X). The posterior distribution is a conditional distribution of the parameters given the prior information and the sample data. The predictive posterior distribution is the conditional distribution of X given the prior information and the sample of data.

The posterior density is obtained as being proportional to the product of the likelihood function and the prior density (according to Bayes' formula). The prior density is said to be non-informative (or diffuse) if the posterior density and the likelihood function are proportional (or almost proportional within the domain of non-zero posterior density). The likelihood function is defined by the joint distribution of X_1, \dots, X_n considered as a function of the parameters.

Corresponding to any fixed choice of a diffuse prior the family of posterior densities is closed under multiplication by the likelihood function. Thus any density from this family used as a prior density leads to a posterior density within the family. Under certain conditions on the type of distribution of X (the distribution must belong to the exponential family), the sample size parameter n in the general expression for the posterior density can be extended from the positive integers to the positive real numbers. This extension leads to a larger family of densities which is also closed under multiplication by the likelihood function. This extended family is called the family of natural conjugate densities to the type of distribution of X . The definition reflects that the probabilistic model of uncertain knowledge formulated by the choice of the prior density needs not be restricted by the fact that sample sizes are integers.

Model uncertainty. The reliability model must be formulated such that it contains elements which are able to reflect model uncertainty at least in a crude way. This may be done for each given adverse state surface (or each given part of a adverse state surface) by associating a judgemental random vector $\mathbf{J} = (J_1, \dots, J_n)$ to the basic random vector $\mathbf{X} = (X_1, \dots, X_n)$. Assuming that there is a one to one transformation by which the standardized joint distribution of \mathbf{X} is mapped into a Gaussian vector $T(\mathbf{X})$ the judgment random vector \mathbf{J} is added to $T(\mathbf{X})$. Next the sum is back-transformed into $\mathbf{Y} = T^{-1}[T(\mathbf{X}) + \mathbf{J}]$. The distribution of \mathbf{Y} is determined by formally assuming that the joint distribution of $(T(\mathbf{X}), \mathbf{J})$ is Gaussian. Finally, the random vector \mathbf{Y} replaces \mathbf{X} in the reliability calculation.

Constants in the model can also be chosen to carry model uncertainty. In that case the constants are interpreted as additional basic random variables.

Models given in current codes of practice are often strongly biased to the conservative side. In order to make a rational reliability analysis by use of such a code-specified model, the bias should be investigated in order to remove it by assigning a proper non-zero mean vector to the judgemental random vector **J**.

Some detailed recommendations about model uncertainty are referred in Appendix 3 to this document.

5 Concept of event margin

An event margin corresponding to a specified event is defined as a function of the basic variables with the property that it takes a negative value if and only if the event occurs.

Event margins related to adverse states are denoted safety margins.

Information becoming available after the design of a structure can be formulated in the framework of event margins. This additional information can be utilized in reliability updating.

During fabrication and service of a structure additional information of the performance becomes available. Actions, material parameters and geometric parameters are realized physically and the design analysis can therefore be updated. Important additional information may arise from material compliance control, proof loading, prototype testing, vibration measurements, action measurements, etc. A part of this information is related to design parameters directly, but some information is related to a functional relation between design parameters and possibly also other parameters such as measurement and inspection errors.

6 Reliability requirements

Decision theoretical principles can be applied in order to obtain optimal reliability levels. It is required, however, that the intangible part of the cost of failure is chosen such that it is comparable in value to the population of failure costs associated with present code based engineering practice when declaring this practice to be optimal. The population of failure costs must correspond to a population of structures with similar failure consequences as for the considered structure.

Optimal reliability levels depend on the reference period. Under stationary conditions and under due consideration of the time sequence of failure occurrences and the capitalization of costs to

present value, the optimal reliability level for the entire reference period decreases with the length of the reference period.

Required minimal reliability levels make sense only together with a specification of a reference period. The reference period should generally equal the anticipated lifetime of the structure (e.g. 100 years). For the reliability measure defined herein the required levels are obtained by calibration to structural dimensions following from present code based engineering practice.

Transient structures are present during construction or remodeling of the structure.

For transient structural situations shorter reference periods with corresponding special reliability requirements can be relevant.

The principle of calibration to existing practice should be kept in operation in a reasonably long transition period during which there will be a backward correcting influence on current practice justified by the experience following from the use of this probabilistic code. After this transition period the reliability requirements (or, alternatively, the requirements on the intangible failure costs including possible risk aversion costs) associated with this code (and gradually established during the transition period) will represent superior practice. There are structural reliability problems in which some few of the relevant basic variables are very difficult to assess by value. This shows up in the form of uncertainty distributions that are considerably more dispersed than the distributions of the other basic variables. In such cases it can be useful to report intermediate reliability analysis results in the form of fragility functions. A fragility function is a conditional probability of failure given the values of one or more basic variables and considered as a function of these values. The fragility function gives information about the sensitivity of the reliability with respect to variation of the conditioning basic variables. Robustness is indicated by slow variation while sensitivity is indicated by steep variation. By this the fragility function indicates where to put the efforts to narrow down the uncertainty distribution of the conditioning variables.

Direct requirements to the fragility functions of continuously varying basic variables are not given. In particular cases where a requirement to a fragility function seems to be needed, it will be indirect through a specification of a mandatory joint distribution of the conditioning basic variables.

Another type of fragility function is obtained by conditioning on different damage states of the structure. This concept is relevant in connection with accidental events, that is, events of strong actions but occurring with such rareness that it is not economically optimal to design the structure to resist these actions without being damaged. In a discretized model each of these accidental events can be defined formally by formulating a structural model by removing one or more elements or parts of the undamaged structure. The failure probability of each of these damaged structures under the relevant actions occurring in a specified time period after the occurrence of the accidental event (evacuation period or repair period) is a fragility function over the set $\{A, B, C, \dots\}$ of

models of damaged structures. The probability distribution over the set $\{A, B, C, \dots\}$ may be so difficult to assess in practice that code requirements to the formulation of the damaged structures (i.e. to the definitions of A, B, C, \dots) and the corresponding fragility function may be needed. The purpose is to ensure structural robustness against progressive collapse, that is, to prevent that the consequences of an accidental event are out of proportion with the extend of the accidental event itself.

Reliability levels to be used in progressive collapse investigations can be based on decision theoretical principles under the same conditions as stated in the first paragraph in this section.

Models with non-stationarity properties are relevant when foreseeing gradual changes in environmental conditions, action history trends, creep phenomena, material deterioration or aging, soil consolidation etc.

In case of non-stationarity modeling of resistance and action properties the reference period should be the anticipated lifetime of the structure. Alternatively a sequence of consecutive shorter than lifetime reference periods can be considered. After each reference period inspection and suitable testing of the structure should be made together with investigations about the actual actions. Upon a reliability updating analysis it can be decided if the structure can be used without changes in the next reference period or whether change of use, strengthening or even demolition should be undertaken. Decision theoretical principles can be used under the same conditions as stated in the first paragraph in this section.

The same inspection and reliability updating decision strategy should be used when considering existing structures which suffer from damage or for which changes of use and environmental conditions are planned or anticipated.

Also the information obtained from regular damage monitoring inspections can be used as the basis for decisions about reliability preserving measures applied to the existing structure.

The occurrence of a serious adverse event sometimes raises a public (political) demand to the engineering profession of using increased reliability requirements with respect to this type of event. Such public reactions are reasonably taken into account in the long run revision of the code with respect to proper updating of the intangible costs related to the experienced adverse events.

Decision theoretical principles should be applied to reevaluate the codified reliability levels in case of experienced adverse events causing severe public reactions.

7 Action modelling

The action models set up for structural reliability analysis must be given sufficiently detailed structure to allow reasonable treatment of action effects caused by the random variation of the actions across the structure and in time. Furthermore the models should allow the study of combined action effects due to several simultaneous actions.

For the macro scale variation in time of an action the basic variable model element is a pulse which is characterized by at least three parameters: a level parameter (intensity), a duration parameter, and an occurrence parameter. Micro scale variations are described by random processes defined by their covariance properties or, equivalently, by their spectral properties.

Such processes are generally derived from the family of Gaussian processes.

There are several applicable stochastic action models based on the concept of an action pulse. The Ferry Borges-Castanheta model (FBC action model) is one of the simplest and most operational of these models: The design life time is for a given action type divided into time intervals of equal length. Within each interval the action has a constant intensity level (possibly vectorial). This intensity level is an outcome of a random variable (vector). The intensities in different intervals can be mutually dependent. Such a sequence of action pulses is called an FBC action history. Any pair of FBC action histories describing two different actions are related to each other at least in the way that the number of intervals in the one action history is an integral multiple of the number of intervals of the other action history.

The problem of combining the action effects of n different FBC action histories is called an FBC n -combination problem.

The FBC action model can be applied in the reliability analysis of the supporting structures of buildings.

Appendix 2 to this document gives an example of a table of prescribed values that specifically define the FBC action models suited for building design.

Other models for action variation in time than the FBC action model can be applied in the reliability analysis of the supporting structures of buildings. Any other such model must be calibrated to model the essential properties of the FBC action model specified in this code, that is, to have the same distribution type for the pulse amplitude, approximately the same mean durations of the pulse, and approximately the same occurrence parameter.

There are several practicable alternatives to the FBC action model. Here only one alternative will be mentioned. It is the Poisson pulse model for action histories with short duration pulses that are separated in time. If the pulse durations are short as compared to the mean time distance between consecutive time points for pulse starts and several such action processes with nonnegative pulse amplitudes are considered for linear combination with nonnegative influence coefficients, the load effect coincidence model of Wen is applicable for determining the distribution of the maximal load effect within a given time period.

The model of Wen assumes that the combined load effect process is a Poisson pulse process defined as the sum of several mutually independent Poisson pulse processes. Each of these processes have pulses with amplitudes that either correspond to pulses that are not overlapping in time with any other pulses, or to an overlapping of two pulses from two selected different load processes, or to overlapping of three pulses from three selected different load processes, etc. With n being the number of processes for combination there are as many processes with their pulses made up of i overlapping pulses as the number of ways i processes can be selected out of n processes (that is, $\binom{n}{i}$ ways).

The probability assignments in the Wen coincidence model is made in such a way that the model leads to a slightly conservative evaluation (that is, overestimations of the maximal combined load effect).

Asymptotic extreme value distributions can only be applied as approximations to the exact distribution of the maximal load effect if special documentation of the validity is given. As documentation the asymptotic argument is not sufficient.

The convergence of the exact extreme value distribution for increasing sample size depends strongly on the generating distribution. Often the convergence is extremely slow giving gross upper tail deviations between the exact extreme value distribution corresponding to a relevant sample size and the corresponding asymptotic distribution.

For any type of structure the reliability analysis must be based on a complete set of action models that together approximately reproduce the essential probabilistic properties of all the different types of relevant action effects that can be expected to come from the future environments and uses of the structure.

For a given structure simple demonstrations or general experience can often be sufficient to justify the exclusion of some of these models with corresponding analyses.

The necessary detailing of the actions models depends on the sensitivity of the considered action effect, that is, on the filtering and the amplification properties as well as the material properties of the structure. Thus different types of action models should be applied dependent on the relevant phenomenon such as long time creep effects, immediate static effects, action effects of concern in fatigue life estimation, dynamic effects that can be amplified by resonance phenomena or self-induced vibrations, impact effects, etc. Also the analysis of progressive collapse phenomena may require its own special action modeling.

For most reliability investigations it is not essential that the action models reproduce the individual action effect histories in their details. The approximate reproduction of the basic probabilistic properties of the action effect histories is often sufficient.

Standardized distributions and process types to be used in action models for specific reliability investigations can be given in an action code to be used in parallel with this code on reliability methods. In such cases the action load model standardizations given in this code are secondary to the standardizations of the action code.

8 Structural resistance modelling

The reliability requirements of this code are for specific failure modes of structural elements such as bars, beams, columns, plates, walls etc. The reliability analysis of larger structural subsystems or the entire structural system must be made in order to investigate whether there are significant system effects on the reliability, and in particular whether such effects are to the side of serious decrease of the reliability. This code allows the use of decision analytical principles to obtain reasonable system reliability levels provided an assessment of the intangible costs of failure has been made as required in Section 6.

Standardized distributions of material properties to be used in structural resistance models can be given in material oriented codes to be used in parallel with this code on reliability methods. Standardized distributions given in such material codes are superior to the standardizations given in this code. It is required that a standardized distribution of a material property assigns zero probability to any set in which no value is possible due to the physical definition of the considered material property.

The requirement of zero probability on physically impossible sets is formulated for guidance of material code writers. It ensures against having for example negative strengths helping the reliability. However, this requirement does not prevent that calculational easier distributions that are not obeying the requirement be used as approximations provided it can be justified that the inconsistency with the physical possibilities contributes insignificantly to the calculated reliability.

Reliability analyses should always be made for each of the structural elements but also to a certain extent for the entire structural system. The structural elements can be defined as smaller or larger subsystems of the entire structural system. Required reliability levels obtained in accordance with the principles in Section 6 will depend on the element definition and will be different for the elements and for the entire system. The required system reliability should be dependent on whether the system failure is of local nature (it can be an element failure) or whether it is global implying much more severe consequences.

The fact that overestimation of the system reliability follows from the use of discretized structural models in the system reliability analyses points at the need for making sensitively analysis with respect to the fineness of the discretization.

Reliability comparisons of different structural systems must be made on the same level of fineness of discretization of the structural system. When comparing the obtained system reliability with the element reliabilities the effect of the discretization on the system level must be taken into account.

The present state-of-the-art of the methods of structural system reliability analysis does not yet permit formulation of very specific code requirements concerning system reliability levels.

A difficult problem is the dependency of the structural resistance on the action history to which the structure is subjected.

System reliability analyses referred to in this code are those for which the system resistance is obtained under fixed in time but random load configurations with the load level increasing proportional with a scalar parameter starting from the self weight load situation and ending at the final random load level situation.

The rigid ideal-plastic theory plays a particular role in the theory of structural system reliability due to the independence of the system resistance of the load history, that is, due to the existence of a load history independent adverse state of collapse. The reliability corresponding to a given reference period is then determined by the probability that the load path does not cross out through the fixed adverse state surface during the reference period.

Other difficult problems are related to the modeling of the constitutive behavior of the potential failure elements in the discretized structural system. In particular problems show up in the modeling of the post failure behavior including problems of post failure interaction between the internal generalized force components. Also here the rigid ideal-plastic theory shows substantial simplifications by adopting the associated flow rule (that is, the condition that the generalized strain vector is orthogonal to the yield condition surface).

Rigid ideal-plastic theory can be used as the basis for system reliability analyses given that the structural system shows ductile collapse behavior. Dependent on the implied degree of idealization of the "real" constitutive behavior more or less biased and dispersed model uncertainty random variables (effectivity factors) must be introduced in the mechanical model. The evaluation of these factors must be justified by proper example studies that include the possibility of having elastic-plastic stability failures.

For discretized systems with brittle failure elements the linear elastic-ideal brittle systems play a role as a practicable study object given that the actions grow in a fixed configuration proportionally

from zero to a final random level. In the linear elastic-ideal brittle system each failure element is removed upon failure.

For brittle systems this code conservatively defines failure of the system as occurring when the first failure of a single failure element occurs. The idealization to a linear elastic-ideal brittle system with suitable model uncertainty variables can be used for analysis of the conservativeness of this definition. Relaxation of the required reliability must be properly justified.

Difficulties of taking the influence of the action history into account have motivated introduction of intuitive definitions of adverse states for structural systems. These definitions are characterized by lack of explicit concern about how the final load on the structure has been established. The system reliability analysis is made solely within a universe of a finite number of random variables describing final actions and resistances. Such adverse state definitions formulated on the basis of engineering judgment and intuition will herein be termed as “jury definitions”.

The effect of structural redundancy can be comparatively studied by use of intelligently chosen jury definitions of the adverse state. Extreme care should be taken when drawing conclusions about the reliability of the real structural system on the basis of such analysis.

9 Reliability models

All decreasing functions of the probability p_f of some adverse event are equivalent measures of safety. They all define the same reliability ordering with respect to adverse events in the space of basic variables (Section 2).

A standard reliability measure may be chosen to be the generalized reliability index. It is defined as

$$\beta = -\Phi(p_f)$$

Another equivalent reliability measure is the probability of the complement of the adverse event (the safe event)

$$p_s = 1 - p_f$$

The probability p_f is calculated on the basis of the standardized joint distribution type of the basic variables and the standardized distributional formalism of dealing with both model uncertainty and statistical uncertainty (Section 4).

The standardized distribution type related to the basic variables of the action models are defined in the action code (Section 7) while the standardized distribution types related to the basic variables of the resistance models are defined in the specific material related codes (Section 8).

If no specific distribution type is given as standard in the action and material codes this code for the purpose of reliability evaluations standardizes the clipped (or, alternatively, the zero-truncated) normal distribution type for basic load pulse amplitudes. Furthermore, the logarithmic normal distribution type is standardized for the basic strength variables.

Deviations from specific geometric measures of physical dimensions as length are standardized to have normal distributions if they act at the adverse state in the same way as load variables (increase of value implies decrease of reliability) and to have logarithmic normal distribution if they contribute to the adverse state in the same way as resistance variables (decrease of value implies decrease of reliability).

The standardization of the logarithmic normal distribution type implies that all the corresponding basic variables of the Gaussian formulation space are obtained by logarithmic transformation of the corresponding basic variables of the original physical formulation space. For the determination of the second moment representation of the basic variables of the Gaussian formulation space the following formulas are valid:

$$E[\log X] = \log[X] - \frac{1}{2} \log(1 + V_X^2)$$

$$\text{Var}[\log X] = \log(1 + V_X^2)$$

$$\text{Cov}[\log X, \log Y] = \log\left(1 + \frac{\text{Cov}[X, Y]}{E[X]E[Y]}\right)$$

in which the pair $(\log X, \log Y)$ is bivariate Gaussian, and

$$\text{Cov}[\log X, Y] = \frac{\text{Cov}[X, Y]}{E[X]}$$

in which the pair $(\log X, Y)$ is bivariate Gaussian. In these formulas “log” is the natural logarithm.

In special situations other than the code standardized distribution types can be relevant for the reliability evaluation. Such code deviating assumptions must be well documented on the basis of a plausible model that by its elements generates the claimed probability distribution type. Asymptotic distributions generated from the model are allowed to be applied only if it can be shown that they by application on a suitable representative example structure lead to approximately the same generalized reliability indices as obtained by application of the exact distribution generated by the model.

Experimental verification without any other type of verification of a distributional assumption that deviates strongly from the standard is only sufficient if very large representative samples of data are available.

Distributional assumptions that deviate from those of the code must in any case be tested on a suitable representative example structure. By calibration against results obtained on the basis of the standardizations of the code it must be guaranteed that the real (the absolute) safety level is not changed significantly relative to the requirements of the code.

The reliability model of this code is a formalistic set of rules that allows engineering decision making on the basis of a mathematically rational processing of available well documented information. It is sufficient for the engineering decision making that the set of rules defines an ordering relation with respect to safety. However, such an ordering relation is not necessarily considered to be sufficient for political decision making. Even though the political decision making problem is outside the scope of this code, some comments are relevant.

Among political decision makers it is often taken for granted that the result of a probabilistic evaluation made by experts has an absolute meaning in the sense of predicting a relative frequency of the considered adverse event. In what sense it is interpretable as a relative frequency is rarely made clear. (Whether this interpretation of the concept of probability is necessary in political decision making is subject to discussions of great controversy among philosophers concerned with the scientific basis of statistics and decision making). Within the topic of structural reliability theory the practicing of this philosophy implies far reaching restrictions imposed on the probabilistic statements that can be given. These restrictions take the form of conditioning statements concerning all those uncertainty sources that are not of direct relative frequency nature. That means, for example, that the uncertainty originating from the lack of precise information about the relevant distribution types cannot be coped with except by giving a "worst case" statement. These are of types as Chebycheff bounds. A reliability measure based on such bounds can be defined. However, it is questionable as a tool for design decision making, first, because it is difficult to calculate except for some idealized particular examples, second, because it, as a worst case statement, in principle increases with more information, be it good or bad information.

Alternatively, if the worst case philosophy is not followed the decision maker is given a set of conditional probability statements which honestly can be claimed to predict the relative frequency of occurrence of the adverse event given the truth of the conditioning statements. In a structural reliability context the conditioning statement is in general a conjunction of many conditioning statements of widely different nature. In order that the decision maker can utilize the given probabilistic information he or she must weigh the different conditioning statements against each other. This means that he or she is forced into the problem of combining the conditional probabilities according to the rule of total probability using weighting probabilities that have no direct relative frequency interpretation. These probabilities are called Bayesian probabilities (or subjective probabilities). The mental process of judgment obviously calls for aiding standardizations of distribution types implying that only the values of some few parameters have to be assessed by professional judgment.

Design by maximization of utility (minimization of total cost) can be made within the framework of this code. However, the cost consequence of some adverse event like loss of human life must be calculated on the basis of the postulate that current design practice as it is approved by the authorities is optimal.

The target values of the generalized reliability index specified in this code (Appendix 1) have been derived by calibration to current design practice. The corresponding value of the formal failure probability p_f is substituted into the cost equation for the considered structure and the failure cost c is determined such that p_f is the optimal failure probability.

Application of optimization design methods is relevant in the case of designing strengthening systems for an existing structure about which updated information is available. By using the failure cost c obtained by calibration to current design practice of a similar new structure (no updated information available for this, naturally) it is possible to make rational decisions about the dimensions of the strengthening system including the two extreme possibilities of either making no strengthening or complete renewal of the structure.

10 Reliability calculation methods

The numerical value of the reliability measure is obtained by a reliability calculation method. Due to the computational complexity a method giving an approximation to the exact result is generally applied.

Two fundamental accuracy requirements are:

- Overestimation of the reliability due to use of an approximative calculation method be within limits generally accepted for the specific type of structure.
- The overestimation of the generalized reliability index must not exceed 5%.

The accuracy of the reliability calculation method is linked to the sensitivity with respect to structural dimensions and material properties in the resulting design. General design practice has inherent rules of acceptable errors since dimensions and material properties are often only available in discrete classes. An error larger than 5% is rarely accepted.

When the modeling of the basic random variables is in terms of a random vector the first-order reliability method (FORM) in general results in a sufficiently accurate approximation to the reliability measure. The FORM analysis is based on a transformation of the basic variables X into standardized normal variables U by the transformation

$$U_i = \Phi^{-1}(F_i(X_i | X_1, \dots, X_{i-1}))$$

The distribution of X_i conditioned upon the value of (X_1, \dots, X_{i-1}) is thus used. The transformation simplifies when the basic random variables are mutually independent. After the transformation the adverse state surface in the normal space is approximated by one or more tangent hyperplanes at the locally most central points. The probability content in the approximation to the failure set is used as an approximation to the failure probability.

If no prior experience with the specific type of adverse state is available, the FORM result should be checked. This can be done locally around the locally most central points by an asymptotic second-order reliability method (SORM), where the adverse state surface is approximated by a second-order surface at the locally most central points, or by an importance sampling around the locally most central points. Globally it should be checked that the most central point has been identified. This can be done by a Monte Carlo simulation, e.g., using directional sampling.

Besides computing the reliability measure it is recommended to check the sensitivity of this reliability measure to all input parameters, i.e., the deterministic basic variables and distribution parameters for the random basic variables. The asymptotic results for the sensitivity of the generalized reliability index are in general sufficiently accurate for this task.

11 List of symbols

$\text{Cov}[,]$	covariance
$D[]$	standard deviation
$E[]$	mean value
$F()$	distribution function
I	judgemental random factor
J	judgemental random variable
n	number of shifts per year
p_f	failure probability
p_s	survival probability
q_c	characteristic value of velocity pressure
s_c	characteristic value of ground snow load
T	transformation of random vector into a Gaussian vector
U	standardized normal variable
V_X	coefficient of variation of X
X	random variable
Y	random variable
β	reliability index
μ	distributional location parameter
Φ	standard normal distribution function
$\rho[,]$	correlation coefficient
σ	distribution dispersion parameter

Bibliography

Books on Reliability Methods

(update per August 1990 of the list in the JCSS document of November 1989)

- [1] Ang, A.H.-S. and Tang, W.H. (1984) *Probability Concepts in Engineering Planning and Design*, Vol. I & II, Wiley, New York.
- [2] Augusti, G., Baratta, A. and Casciati, F. (1984) *Probabilistic Methods in Structural Engineering*, Chapman and Hall, London.
- [3] Benjamin, J.R. and Cornell, C.A. (1970) *Reliability, Statistics and Decision for Civil Engineers*, McGraw Hill, New York.
- [4] Bolotin, V.V. (1981) *Wahrscheinlichkeitsmethoden zur Berechnung von Konstruktionen*, VEB Verlag für Bauwesen.
- [5] Borges, J.F. and Castanheta, M. (1971) *Structural Safety* Laboratório Nacional de Engenharia Civil, Lisbon, Portugal.
- [6] Ditlevsen, O. (1981) *Uncertainty Modeling with Applications to Multidimensional Civil Engineering Systems*, McGraw Hill, New York.
- [7] ¹ Ditlevsen, O. and Madsen, H.O. (1996) *Structural Reliability Methods*, Wiley, Chichester, (translation and extension of SBI-rapport 211: *Bærende Konstruktioners Sikkerhed*, 1990). (Second edition September 2002 (edition 2.1) published as an internet publication for free download from the address: <http://www.mek.dtu.dk/staff/od/papers.htm>).
- [8] Madsen, H.O., Krenk, S. and Lind, N.C. (1986) *Methods of Structural Safety*, Prentice-Hall, New York.
- [9] Melchers, R.E. (1987) *Structural Reliability and Predictions* Ellis Horwood/Wiley, Chichester.
- [10] Schuëller, G. (1981) *Einführung in der Sicherheit und Zuverlässigkeit von Tragwerken*, Verlag Wilhelm Ernst & Son, Berlin.
- [11] Thoft-Christensen, P. and Baker, M. (1982) *Structural Reliability Theory and its Applications*, Springer Verlag, Berlin.
- [12] Thoft-Christensen, P. and Murotsu, Y. (1986) *Application of Structural Systems Reliability Theory*, Springer Verlag, Berlin.
- [13] Wen, Y.-K. (1990) *Structural Load Modeling and Combination for Performance and Safety Evaluation. Developments in Civil Engineering*, Elsevier, Amsterdam.

Present Codes and Model Codes ²

- [14] American Institute of Steel Construction (AISC) (1986) *Load and Resistance Factor Design Specifications*, AISC, Chicago.
- [15] American National Standard Institute (ANSI) (1982) *American National Standard Minimum Design Loads for Building and other Structures*, ANSI A58.1, ANSI, New York.
- [16] CEB (1976) *First Order Concepts for Design Codes*, CEB Bulletin No. 112, Munich.

¹Reference [7] is updated per September 2002

²The status per 2002 concerning the JCSS probabilistic model code can be obtained from <http://www.iabse.ethz.ch/lc/jcss.html>

- [17] CEB (1976) *Common Unified Rules for Different Types of Construction and Material*, Vol.I, CEB Bulletin No. 116, Paris.
- [18] CIRIA (1977) *Rationalisation of Safety and Serviceability Factors in Structural Codes*, CIRIA Report No. 63, London.
- [19] ISO (1984) *General Principles on Reliability for Structures*, ISO/DIS 2394.
- [20] NBS (1980) *Development of a Probability Based Load Criterion for American National Standard A58*, U.S. Department of Commerce, NBS Special Publication 577.
- [21] Nordic Committee for Building Structures (NKB) (1978) *Recommendation for Loading and Safety Regulations for Structural Design*, NKB Report No. 36.
- [22] Ontario Ministry of Transportation (OMTC) (1983) *Ontario Highway Bridge Design Code*, OMTC Downsview, Ontario.

Appendix 1 Example of reliability requirements

Table 1 gives an example of required values of the generalized reliability index (Section 9). The values are obtained by calibration to Danish practice of design of buildings and similar structures (source: The Nordic Committee on Building Regulations, Ref. 20).

The table shows a dependence of the required values of both the reliability class and the type of failure. Both classifications refer to the consequences of failure and reflect a calibration in accordance with decision theoretical principles. The reliability class solely refers to the use of the structure and the nature of the nearest surroundings of the structure (densely populated surroundings or rural surroundings). The type of failure classification refers to possible warnings of failure and less dramatic development of the failure.

Table 1
Example of reliability index requirements

(reference period 1 year)	safety class	type of failure		
		ductile with reserves	ductile without reserves	brittle
	low	3.1	3.7	4.2
	normal	3.7	4.2	4.7
	high	4.2	4.7	5.2

Moreover, the table column marked “ductile with reserves” refers to substantial carrying capacity reserves not utilized in the mathematical model of the adverse state.

Required reliability index values for other reference periods than the 1 year period must be determined by use of a suitable action model as for example the FBC action model specifically defined by Table 2.

Appendix 2 Example of action model parameters

Table 2 with scalar data is an example of prescribed values (up to revision) suited for design in Denmark. The numbers may be different in different geographical regions. (Alternatively, such kinds of tables are placed in an action code.)

The table contains prescribed values for building design. For loads on different floors a suitable model formulation should include the possibility of having correlation between intensities. This correlation is particularly important for multistorey car parks.

Drift of snow must be considered in the roof load model. This model contributes to a part of the mathematical definition of the actual adverse state in the physical formulation space. The model is formulated by use of form factors defined in the action code under due consideration of the topography of the building and its landscape surroundings. In principle it may contain both the random snow load variable $\max\{0, X_{\text{snow}}\}$, the random wind load variable $\max\{0, X_{\text{wind}}\}$, and the random wind direction. The wind direction is discretely or continuously distributed over 8 sectors with a probability distribution derived from the wind rosette for the actual locality. Within the same pulse interval of the wind load the wind direction is kept constant. Snow load, wind load, and wind direction may be considered stochastically independent of the loads on the floors. For the wind load the values of μ and σ in the table correspond to an equivalent uniform velocity pressure (constant influence function = 1) over a square of side length 50 m. It is emphasized that

Table 2

Example of action model parameters.

Data for the Ferry Borges-Castanheta load model for buildings valid for a 1 year time period (calibrated crudely to Danish codes).

Load intensity = $\max\{0, X\}$ (clipped Gaussian), X Gaussian, $E[X] = \mu$, $D[X] = \sigma$.

		No. of shifts per year n	μ (kN/m ²)	σ (kN/m ²)
self weight		1/100		
floor loads:				
	residences	long term	1/20	0.5
		short term	400	-0.75
	offices and schools	long term	1/20	0.60
		short term	400	-2.00
	hotels	long term	1/40	0.30
		short term	200	-1.50
	multistorey car parks		400	-3.50
natural loads:				
	snow load (ground)*		5	$0.20s_k$
	wind load (ground)**		400	$-0.32q_c$

* s_k is the characteristic value of the ground snow load given in the action code.

Snow load is only occurring in the half year of winter.

** q_c is the characteristic value of the velocity pressure given in the action code.

NOTE: values are up for revision.

μ and σ are not the mean value and the standard deviation, respectively, of the load intensity. The

parameters μ , σ and n are determined by requiring (a) that

$$\Phi\left(\frac{x - \mu}{\sigma}\right)^n = 0.98$$

in which x is the 98% fractile in the distribution of the annual extreme for the considered load corresponding to a return period of 50 years, (b) that $\Phi(\mu/\sigma)$ is the average fraction of the season period with the considered action type acting, and (c) that $n\Phi[(\mu - x_0)/\sigma]$ is the average number of periods per year in the season period with the load intensity larger than x_0 .

For the wind load, x_0 is put to that fraction of the characteristic velocity pressure q_c that corresponds to a mean number of exceedances of 20 per year. For other types of actions, x_0 is put to zero.

The conditions are fulfilled with the degree of approximation which is enforced by the restrictions in the FBC-model about the interval divisions.

Appendix 3 Example of model uncertainty specifications

Since a basic strength variable according to this code is transformed logarithmically, an additive model uncertainty judgemental random variable J in the transformed space (Section 4) corresponds to a judgemental random factor I on the basic strength variable X itself. The expectation and the coefficient of variation of XI can be determined from the formulas

$$E[XI] = E[X]E[I](1 + \rho[X, I]V_XV_I)$$

$$1 + V_{XI}^2 = (1 + V_X^2)(1 + V_I^2)(1 + \rho[X, I]V_XV_I)^2$$

On the basis of calibrations it is recommended to split the judgemental factor I into three mutually independent lognormally distributed factors I_1, I_2, I_3 for which Table 3 is given (source: The Nordic Committee on Building Regulations, Ref. 21).

Table 3
Example of judgemental factor statistics

$j = 1$	good	normal	bad
$j = 2$	small	medium	large
$j = 3$	strict	normal	gentle
V_{I_j}	0.04	0.06	0.09
$\rho[X, I_j]$	-0.3	0.0	0.3

The classifications in the table are as follows:

$j = 1$: degree of realism in the prediction of failure by idealized failure criterion.

$j = 2$: uncertainty concerning the relation between the strength parameter in the structure and the specified substitute of the parameter defined in the description of the structure.

$j = 3$: extent of control on site of the identity of materials and of building process.

These values of V_{I_j} and $\rho[X, I_j]$ (open to revision) are used in the formulas

$$E[I] = E[I_1]E[I_2]E[I_3]$$

$$1 + V_I^2 = (1 + V_{I_1}^2)(1 + V_{I_2}^2)(1 + V_{I_3}^2)$$

$$1 + \rho[X, I]V_X V_I = \prod_{j=1}^3 (1 + \rho[X, I_j]V_X V_{I_j})$$

For the load amplitudes in the FBC action model a model uncertainty correction of the form $\max\{0, X_i + J_i + J\}$ can be applied. The index i refers to the i th pulse in a given action history and J is common to the entire action history. The random variables $J, J_1, \dots, X_1, \dots$ can be assumed to be mutually independent unless there are strong reasons to assume otherwise. Calibration studies indicate that the standard deviations of all the judgemental random variables can reasonably be put to (up to revision)

$$0.15[\mu + \sigma\Phi^{-1}(0.98^{1/n})]$$

in which n, μ, σ are the values given in Table 2 that defines the FBC action model.

This page is intentionally left blank

Index

- χ^2 -density, 5
- Bayesian statistics, 3, 16
- Behren's distribution, 12
- calibration of mathematical models, 14
- Cauchy's density, 6
- chi-square (χ^2) density, 5
- diffuse density, 4
- distribution
 - Behren's, 12
 - Cauchy, 6
 - chi-square (χ^2), 5
 - diffuse, 4
 - natural conjugate prior, 3
 - non-informative prior, 3
 - posterior, 4
 - predictive, 6
 - prior, 2
 - Rayleigh, 8
 - Student's t , 6, 17
- experimental determination of model errors, 14
- exponential
 - family, 2
- formulation invariance, 22
- gradient angle calculation, 23
- likelihood function, 2
- linear
 - model, 15
- missing prior information, 3
- model
 - uncertainty, 14, 20
- model-correction-factor method, 26
- natural conjugate prior densities, 3
- non-informative prior density, 3
- posterior density, 4
- power product model, 16
- predictive density, 6
- prior density, 2
- Rayleigh density, 8
- response-surface method, 23
- sample information, 7
- statistical uncertainty, 1
- Student's t -distribution, 6, 17
- sufficient statistics, 2